



# Industrial and Sanitary Variable Speed VFD Controllers For 60 Hz Gearmotors

## Setup, Operation & Maintenance Manual



DORNER MFG. CORP.  
P.O. Box 20 • 975 Cottonwood Ave.  
Hartland, WI 53029-0020 USA

INSIDE THE USA  
TEL: 1-800-397-8664  
FAX: 1-800-369-2440

OUTSIDE THE USA  
TEL: 262-367-7600  
FAX: 262-367-5827

For other service manuals visit our website at:  
[www.dorner.com/service\\_manuals.asp](http://www.dorner.com/service_manuals.asp)

---

# Table of Contents

---

Introduction .....	2	Sanitary Controller Mounting	
Warnings – General Safety .....	3	(7350, 7400 and 7600 Series Conveyors) .....	6
Product Description .....	4	Industrial Controller Mounting .....	7
Specifications .....	4	2200, 3200 and 5200 Conveyor Mounting .....	7
Industrial Controllers .....	4	6200 Conveyor Mounting .....	8
Sanitary Controllers .....	4	Aluminum Stand Leg Mounting .....	9
Installation .....	5	Wiring .....	10
Required Tools .....	5	Preventive Maintenance and Adjustment .....	11
Determine Conveyor Type .....	5	Required Tools .....	11
Sanitary Conveyors .....	5	Controller Setup .....	11
Industrial Conveyors .....	5	Service Parts .....	11
Sanitary Controller Mounting		Return Policy .....	12
(7200 and 7300 Series Conveyors) .....	5		

---

## Introduction

---

<b>IMPORTANT</b>
------------------

Some illustrations may show guards removed. Do NOT operate equipment without guards.
--

Upon receipt of shipment:

- Compare shipment with packing slip. Contact factory regarding discrepancies.
- Inspect packages for shipping damage. Contact carrier regarding damage.
- Accessories may be shipped loose. See accessory instructions for installation.

Dorner conveyors are covered by the following patent numbers: 5131529, 5156260, 5156261, 5174435, 5203447, 5265714, 5875883, and corresponding patents and patent applications in other countries.

Dorner's Limited Warranty applies.

Dorner reserves the right to make changes at any time without notice or obligation.

## Warnings – General Safety

### WARNING

The safety alert symbol, black triangle with white exclamation, is used to alert you to potential personal injury hazards.

### DANGER



Climbing, sitting, walking or riding on conveyor will cause severe injury.  
**KEEP OFF CONVEYORS.**

### DANGER



**DO NOT OPERATE CONVEYORS IN AN EXPLOSIVE ENVIRONMENT.**

### WARNING

Controller must be properly grounded. Failure to properly ground controller may cause injury to personnel.

### DANGER



Hazardous voltage will cause severe injury or death.  
**LOCKOUT POWER BEFORE wiring.**

### WARNING



Exposed moving parts can cause severe injury.  
**DO NOT ATTEMPT ADJUSTMENTS WITH CONVEYOR RUNNING.**

### WARNING



Dorner cannot control the physical installation and application of conveyors. Taking protective measures is the responsibility of the user.

When conveyors are used in conjunction with other equipment or as part of a multiple conveyor system, **CHECK FOR POTENTIAL PINCH POINTS** and other mechanical hazards before system start-up.

# Product Description

Dorner Variable Speed VFD Controllers (**Figure 1**) are AC motor speed controllers for Standard and Heavy Load VFD gearmotors.

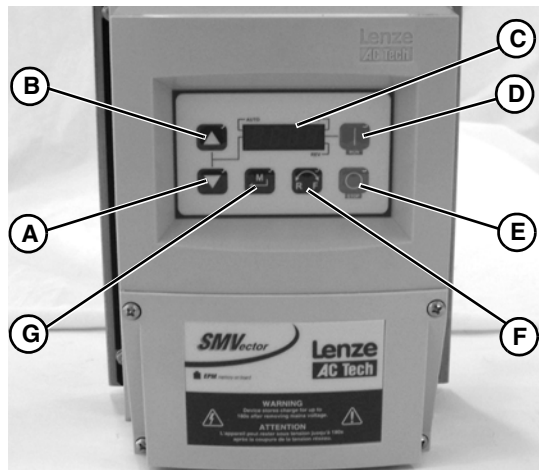

**Figure 1**

## NOTE

For additional information, refer to the Lenze SMVector Frequency Inverter Operating Instructions shipped with your controller. See Specifications table for models.

### Illustration References:

- A Decrease Speed Button
- B Increase Speed Button
- C Display
- D Start Button
- E Stop Button
- F FWD/REV (Forward/Reverse) Button
- G Enter Button

# Specifications

## Industrial Controllers

Dorner Model Number	Input Voltage & Phase (Input at 60 Hz)	Output Voltage & Phase	Output Frequency	Maximum Hp (kW)	Maximum Output in Amperes	Manufacturer's Model Number
32MV1122	115 Single Phase	230 Volts- Three Phase	6 to 60 Hz	0.5 (0.37)	2.2	ESV371N01SXC
32MV2122	230 Single Phase	230 Volts- Three Phase	6 to 60 Hz	0.5 (0.37)	2.2	ESV371N01SXC
32MV1121	115 Single Phase	230 Volts- Three Phase	6 to 60 Hz	1.0 (0.75)	4	ESV751N01SXC
32MV2121	230 Single Phase	230 Volts- Three Phase	6 to 60 Hz	2.0 (0.75)	4	ESV751N01SXC
32MV2127	230 Single Phase	230 Volts- Three Phase	6 to 60 Hz	2.0 (1.5)	6.8	ESV152N02YXC
32MV2322	230 Three Phase	230 Volts- Three Phase	6 to 60 Hz	0.5 (0.37)	2.2	ESV371N02YXC
32MV2327	230 Three Phase	230 Volts- Three Phase	6 to 60 Hz	2.0 (1.5)	6.8	ESV152N02YXC
32MV4341	460 Three Phase	460 Volts- Three Phase	6 to 60 Hz	1 (0.75)	2	ESV751N04TXC
32MV4347	460 Three Phase	460 Volts- Three Phase	6 to 60 Hz	2 (1.5)	3.4	ESV152N04TXC

## Sanitary Controllers

Dorner Model Number	Input Voltage & Phase (Input at 60 Hz)	Output Voltage & Phase	Output Frequency	Maximum Hp (kW)	Maximum Output in Amperes	Manufacturer's Model Number
72MV1124S	115 Single Phase	230 Volts- Three Phase	10 to 60 Hz	0.25 (0.18)	1.4	ESV371N01SXC
72MV2124S	230 Single Phase	230 Volts- Three Phase	10 to 60 Hz	0.25 (0.18)	1.4	ESV371N01SXC
72MV1122S	115 Single Phase	230 Volts- Three Phase	10 to 60 Hz	0.5 (0.37)	2.2	ESV371N01SXC
72MV2322S	230 Three Phase	230 Volts- Three Phase	10 to 60 Hz	0.5 (0.37)	2.2	ESV371N02YXC
76MV1122S	115 Single Phase	230 Volts- Three Phase	10 to 60 Hz	0.5 (0.37)	2.2	ESV371N01SXC
76MV2322S	230 Three Phase	230 Volts- Three Phase	10 to 60 Hz	0.5 (0.37)	2.2	ESV371N02YXC
76MV1121S	115 Single Phase	230 Volts- Three Phase	10 to 60 Hz	1 (0.75)	4	ESV751N01SXC
76MV2121S	230 Single Phase	230 Volts- Three Phase	10 to 60 Hz	1 (0.75)	4	ESV751N01SXC
76MV4341S	460 Three Phase	460 Volts- Three Phase	10 to 60 Hz	1 (0.75)	2	ESV751N04TXC
76MV2127S	230 Single Phase	230 Volts- Three Phase	10 to 60 Hz	2 (1.5)	6.8	ESV152N02YXC
76MV2327S	230 Three Phase	230 Volts- Three Phase	10 to 60 Hz	2 (1.5)	6.8	ESV152N02YXC
76MV4347S	460 Three Phase	460 Volts- Three Phase	10 to 60 Hz	2 (1.5)	3.4	ESV152N04TXC

Industrial and Sanitary Variable Speed VFD Controllers For 60 Hz Gearmotors

## Required Tools

- Hex key wrenches:  
4 mm, 5 mm
- Wrenches 8 mm, 10 mm
- Flat-blade screwdriver
- Torque wrench

## Determine Conveyor Type

Select the appropriate section based on your conveyor type:

### Sanitary Conveyors

- For 7200 and 7300 series conveyors, see “Sanitary Controller Mounting (7200 and 7300 Series Conveyors)” on page 5.
- For 7350, 7400 and 7600 series conveyors, see “Sanitary Controller Mounting (7350, 7400 and 7600 Series Conveyors)” on page 6.

### Industrial Conveyors

- For 2200, 3200 and 5200 series conveyors, see “2200, 3200 and 5200 Conveyor Mounting” on page 7.
- For 6200 series conveyors, see “6200 Conveyor Mounting” on page 8.
- For aluminum stand leg mounting, see “Aluminum Stand Leg Mounting” on page 9.

## Sanitary Controller Mounting (7200 and 7300 Series Conveyors)

<b>⚠ WARNING</b>

<p>Exposed moving parts can cause severe injury.</p> <p><b>LOCK OUT POWER</b> before removing guards or performing maintenance.</p>

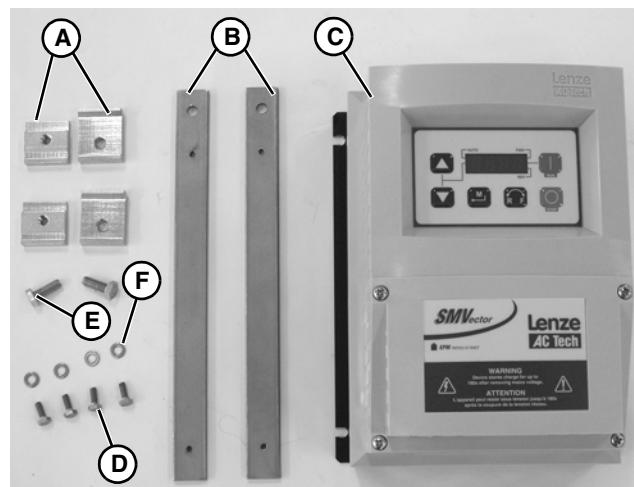
## Installation Component List (Figure 2):



**Figure 2**

- |   |   |
|---|---|
| A | Accessory Mounting Clips (2x)<br>(Shipped with gearmotor mount package) |
| B | Controller Mounting Bar (2x)  |
| C | Sanitary VFD Controller   |
| D | Hex Head Screws, M5 x 8 mm (4x)   |
| E | Hex Head Screws, M6 x 16 mm (2x)  |
| F | Washers, M5 (4x)  |

1. Attach mounting bars (**Figure 3, item B**) to controller (**Figure 3, item C**) with washers (**Figure 3, item F**) and screws (**Figure 3, item D**).

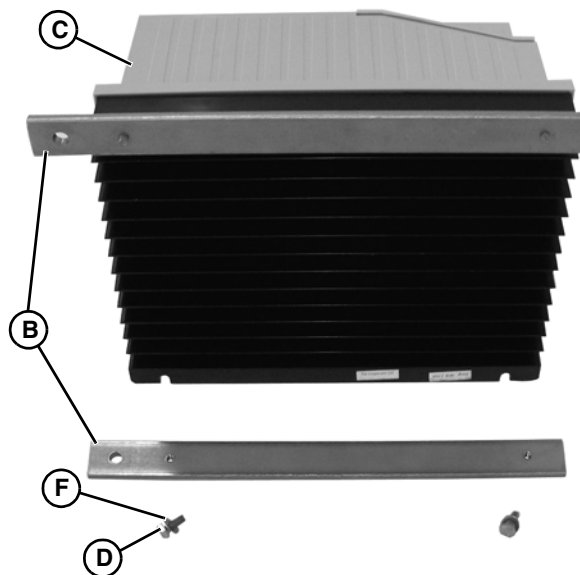

**Figure 3**

# Installation

- Loosely attach clips (Figure 4, item A) to mounting bar (Figure 4, item B) with M6 x 16 mm screws (Figure 4, item E).

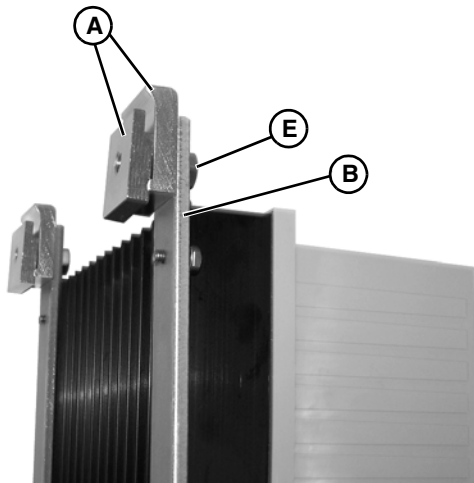

Figure 4

- Attach controller (Figure 5, item A) to conveyor (Figure 5, item G) with screws (Figure 5, item E).

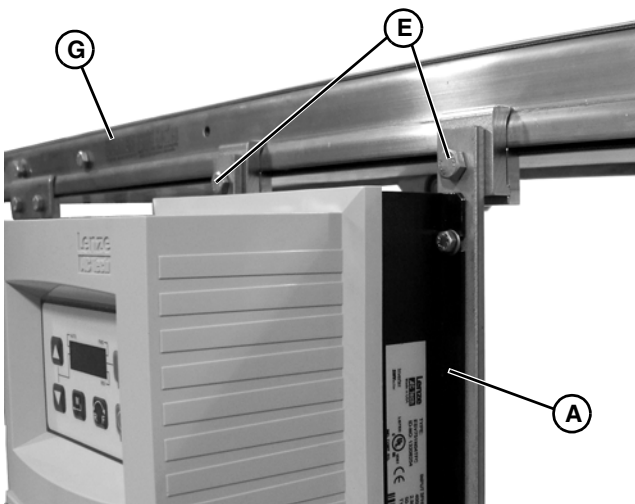



Figure 5

## Sanitary Controller Mounting (7350, 7400 and 7600 Series Conveyors)

**⚠ WARNING**



Exposed moving parts can cause severe injury.  
**LOCK OUT POWER** before removing guards or performing maintenance.

### Installation Component List (Figure 6):

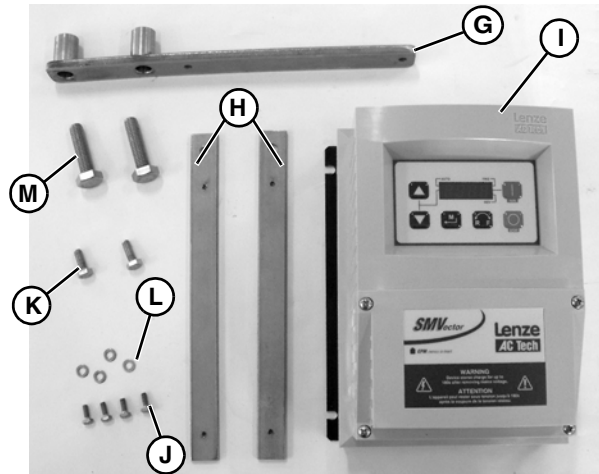

Figure 6

G	Conveyor Mounting Bar
H	Controller Mounting Bar (2x)
I	Sanitary VFD Controller
J	Hex Head Screws, M5 x 8 mm (4x)
K	Hex Head Screws, M6 x 16 mm (2x)
L	Washers, M5 (4x)
M	Hex Head Screws, M10 (2x)

- Attach controller mounting bars (Figure 7, item H) to controller (Figure 7, item I) with washers (Figure 7, item L) and screws (Figure 7, item J).

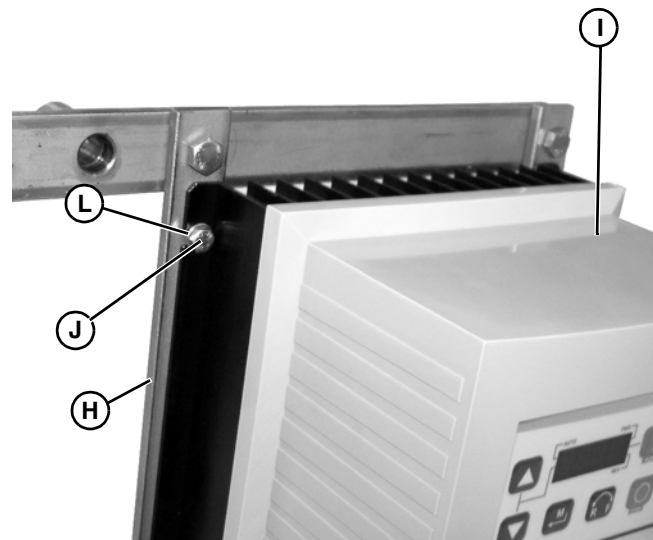

Figure 7

# Installation

2. Attach controller mounting bars (Figure 8, item H) to conveyor mounting bar (Figure 8, item G) with M6x16 mm screws (Figure 8, item K).

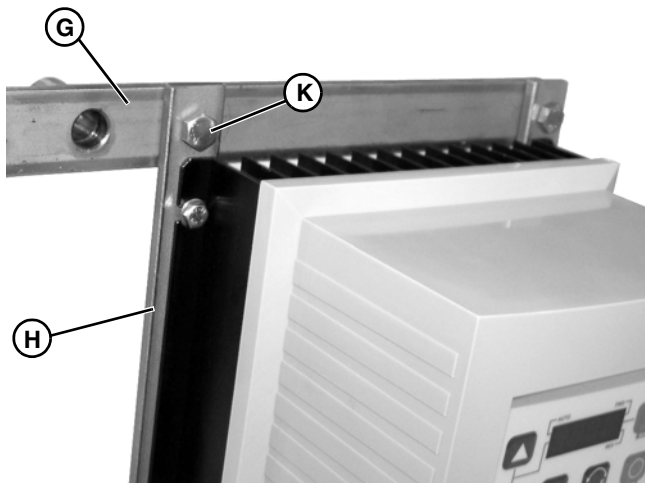

Figure 8

3. Install assembly to conveyor at stand location. Remove stand screws and replace with new screws (Figure 9, item M).

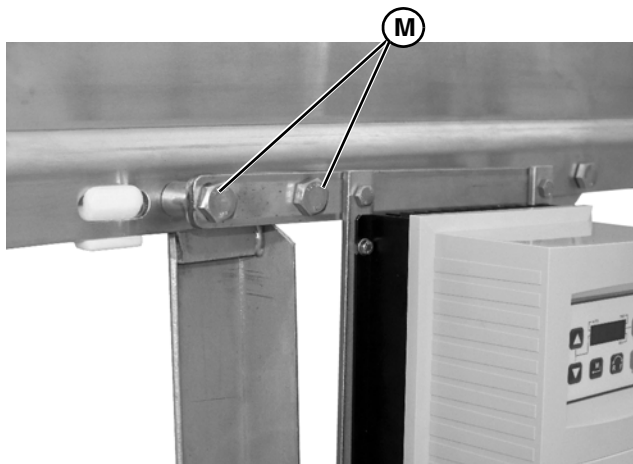

Figure 9

## Industrial Controller Mounting

<b>⚠ WARNING</b>
<p>Exposed moving parts can cause severe injury.</p> <p><b>LOCK OUT POWER</b> before removing guards or performing maintenance.</p>

## 2200, 3200 and 5200 Conveyor Mounting

Installation Component List (Figure 10):

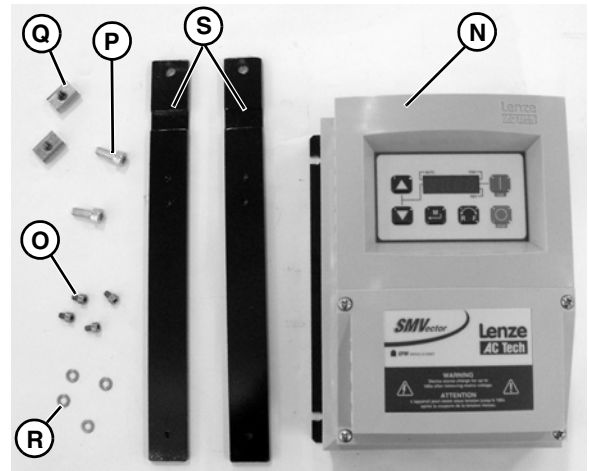

Figure 10

N	Industrial VFD Controller
O	Socket Head Screws M5 x 8 mm (4x)
P	Socket Head Screws M6 x 16 mm (2x)
Q	T-Bars (2x)
R	Washers, M5 (4x)
S	Controller Mounting Bar (2x)

1. Attach mounting bars (Figure 11, item S) to controller (Figure 11, item N) with M5 x 8 mm screws (Figure 11, item O) and M5 washers (Figure 11, item R).

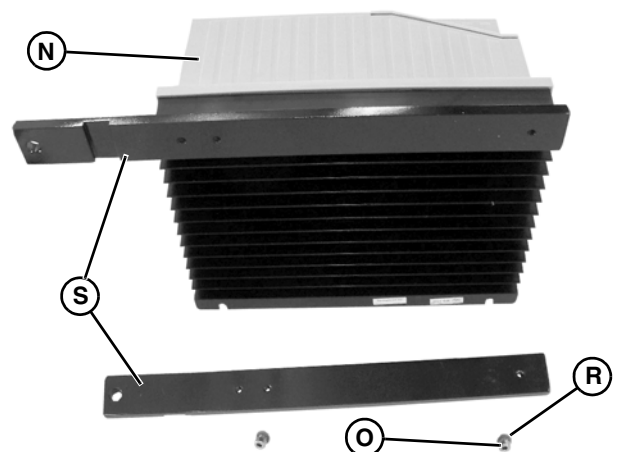
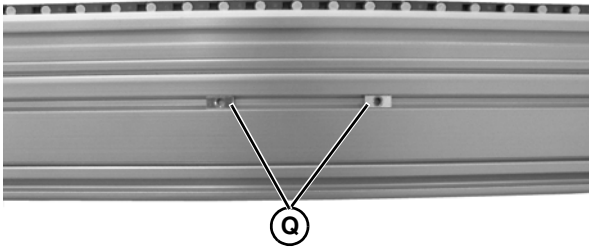

Figure 11



# Installation

2. Install T-bars (**Figure 12, item Q**) in 2200 Series, 3200 Series or 5200 Series conveyor T-slots.



**Figure 12**

3. Attach controller (**Figure 13, item N**) to conveyor with M6 x 16 mm screws (**Figure 13, item P**).

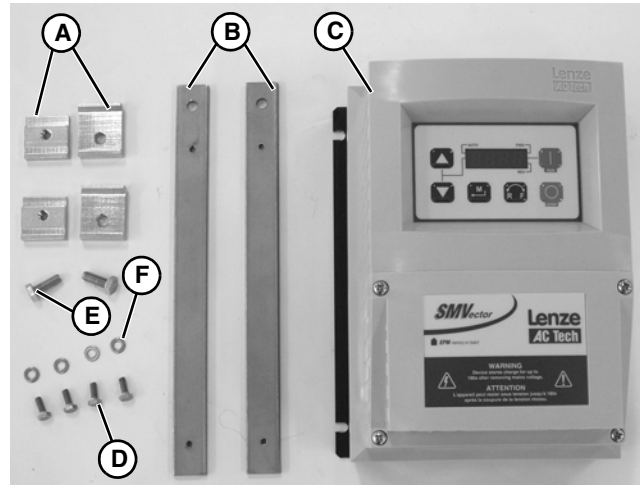

**Figure 13**

## 6200 Conveyor Mounting

<b>⚠ WARNING</b>
<p>Exposed moving parts can cause severe injury.  <b>LOCK OUT POWER</b> before removing guards or performing maintenance.</p>

## Installation Component List (Figure 2):



**Figure 14**

- |   |   |
|---|---|
| A | 6200 Series Accessory Mounting Clips (2x) |
| B | Controller Mounting Bar (2x)              |
| C | Industrial VFD Controller                 |
| D | Hex Head Screws, M5 x 8 mm (4x)           |
| E | Hex Head Screws, M6 x 16 mm (2x)          |
| F | Washers, M5 (4x)                          |

1. Attach mounting bars (**Figure 3, item B**) to controller (**Figure 3, item C**) with washers (**Figure 3, item F**) and screws (**Figure 3, item D**).

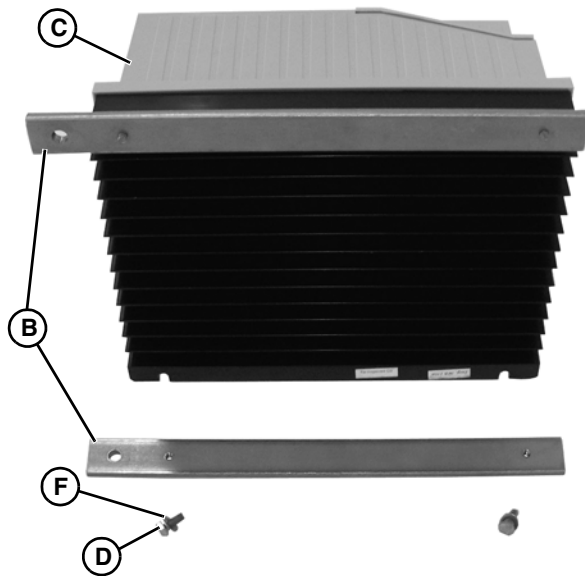

**Figure 15**



2. Loosely attach clips (Figure 4, item A) to mounting bar (Figure 4, item B) with M6 x 16 mm screws (Figure 4, item E).

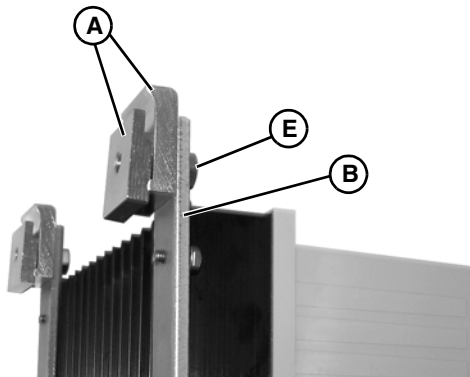

Figure 16

3. Attach controller (Figure 5, item A) to conveyor (Figure 5, item G) with screws (Figure 5, item E).

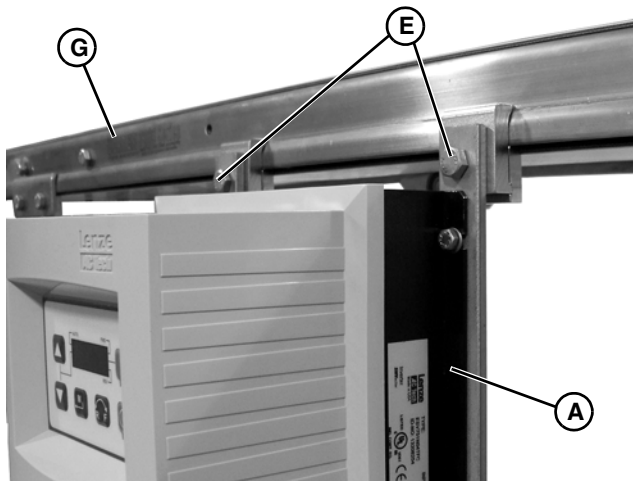

Figure 17

## Aluminum Stand Leg Mounting

1. Attach mounting bars (Figure 18, item S) to controller (Figure 18, item N) with M5 x 8 mm screws (Figure 18, item O) and M5 washers (Figure 18, item R).

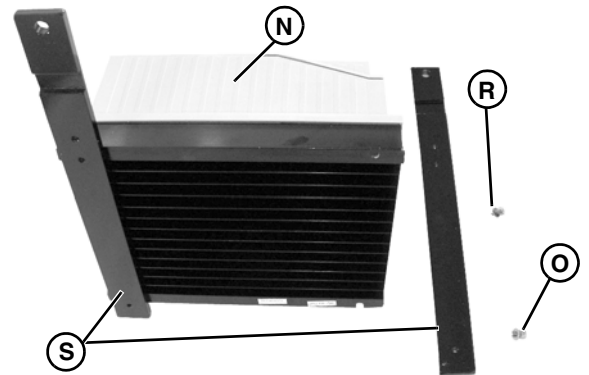

Figure 18

2. Install T-bar (Figure 19, item Q) into stand leg T-slot. Attach controller lower mounting bar (Figure 19, item T) with screw (Figure 19, item P).

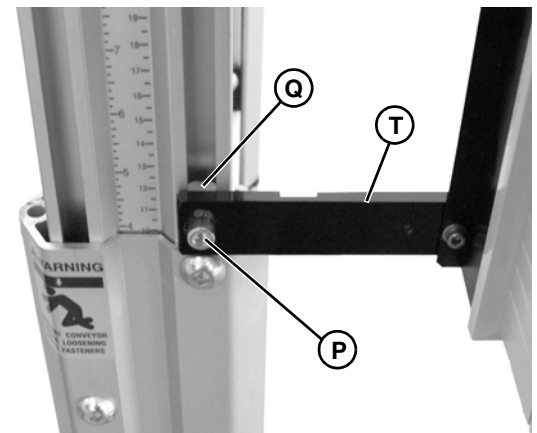

Figure 19

3. Temporarily tighten screw (Figure 20, item P). Install second T-bar (Figure 20, item Q) into T-slot.

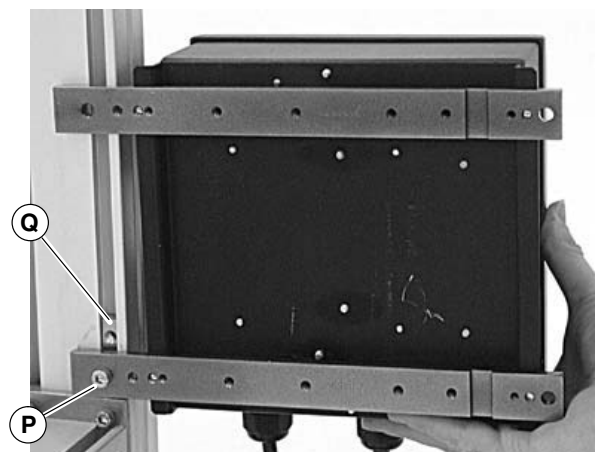

Figure 20

# Installation

- With screwdriver (Figure 21, item U), raise T-bar (Figure 21, item Q) to align it with hole in top mounting bar. Insert M6 screw (Figure 21, item P) and partially thread into T-bar.

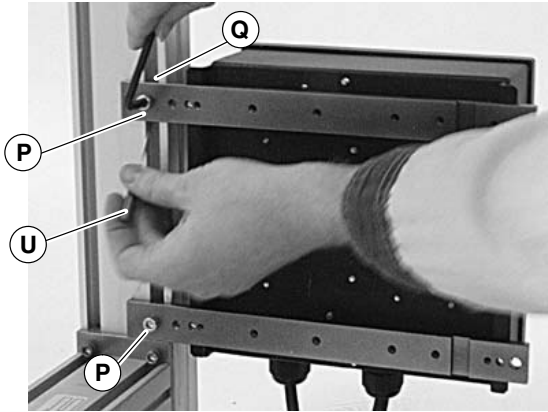

Figure 21

- Slide controller to its desired mounting location (Figure 22) and tighten both screws (Figure 21, item P).



Figure 22

## Wiring

### **⚠ DANGER**



Hazardous voltage will cause severe injury or death.

**LOCKOUT POWER BEFORE wiring.**

### **⚠ WARNING**



Exposed moving parts can cause severe injury.

**LOCK OUT POWER before removing guards or performing maintenance.**

### **⚠ WARNING**

Controller must be properly grounded. Failure to properly ground control box may cause injury to personnel.

### **NOTE**

*A circuit breaker or a disconnect switch with fuses must be provided in accordance with the National Electrical Code (NEC) and all local codes.*

*Refer to Lenze Installation and Operating Manual shipped with your controller.*

### **NOTE**

*For electrical wiring or troubleshooting, refer to information provided by controller manufacturer.*

- Make the input power connections through the line connection cord grip. Refer to the manufacturer's manual for terminations inside the VFD controller.

---

# Preventive Maintenance and Adjustment

---

## Required Tools

- Flat-blade screwdriver

## Controller Setup

<b>⚠ DANGER</b>

<b>Hazardous voltage will cause severe injury or death.</b> <b>LOCKOUT POWER BEFORE wiring.</b>

<b>⚠ WARNING</b>

<b>Exposed moving parts can cause severe injury.</b> <b>LOCK OUT POWER before removing guards or performing maintenance.</b>

<b>NOTE</b>
<i>For additional information or desired settings other than listed, refer to the Lenze SMVector Frequency Inverter Operating Instructions shipped with your controller. See Specifications table for model.</i>

When purchased with a gearmotor, Dorner configures Variable Speed VFD Controllers as follows:

- 1 second acceleration time
- 1 second deceleration time
- Minimum frequency @ 10 Hz for Sanitary units, 6 Hz for Industrial units
- Maximum frequency @ 60 Hz
- Overloads set to motor Full Load Amperes (FLA)

---

## Service Parts

---

<b>NOTE</b>
<i>For replacement parts, refer to the manual shipped with your controller.</i>

# Return Policy

Returns must have prior written factory authorization or they will not be accepted. Items that are returned to Dorner without authorization will not be credited nor returned to the original sender. When calling for authorization, please have the following information ready for the Dorner factory representative or your local distributor:

1. Name and address of customer.
2. Dorner part number(s) of item(s) being returned.
3. Reason for return.
4. Customer's original order number used when ordering the item(s).
5. Dorner or distributor invoice number.

A representative will discuss action to be taken on the returned items and provide a Returned Goods Authorization number for reference.

There will be a return charge on all new undamaged items returned for credit where Dorner was not at fault. Dorner is not responsible for return freight on such items.

## Conveyors and conveyor accessories

Standard catalog conveyors	30%
MPB Series, cleated and specialty belt conveyors	50%
AquaGard & AquaPruf Series conveyors	non-returnable items
Engineered special products	case by case
Drives and accessories	30%
Sanitary stand supports	non-returnable items

## Parts

Standard stock parts	30%
MPB, cleated and specialty belts	non-returnable items

Returns will not be accepted after 60 days from original invoice date.

The return charge covers inspection, cleaning, disassembly, disposal and reissuing of components to inventory.

If a replacement is needed prior to evaluation of returned item, a purchase order must be issued. Credit (if any) is issued only after return and evaluation is complete.

Dorner has representatives throughout the world. Contact Dorner for the name of your local representative. Our Technical Sales, Catalog Sales and Service Teams will gladly help with your questions on Dorner products.

For a copy of Dorner's Warranty, contact factory, distributor, service center or visit our website at [www.dorner.com](http://www.dorner.com).

For replacement parts, contact an authorized Dorner Service Center or the factory.



Dorner Mfg. Corp. reserves the right to change or discontinue products without notice. All products and services are covered in accordance with our standard warranty. All rights reserved. © Dorner Mfg. Corp. 2006

## DORNER MFG. CORP.

975 Cottonwood Ave., PO Box 20  
Hartland, WI 53029-0020 USA  
USA  
TEL 1-800-397-8664 (USA)  
FAX 1-800-369-2440 (USA)  
Internet: [www.dorner.com](http://www.dorner.com)

Outside the USA:  
TEL 1-262-367-7600  
FAX 1-262-367-5827