

2100, 4100, 6100 Series Top Mount Drive Package for Light Load 60 Hz Gearmotors

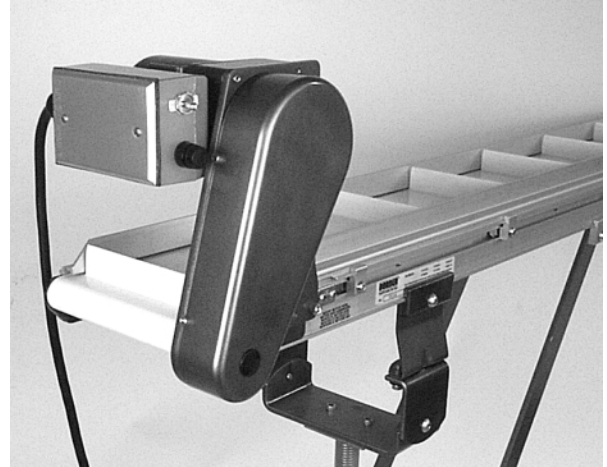

Table of Contents

Warnings – General Safety	2	Preventative Maintenance & Adjustment	6
Introduction	2	Required Tools	6
Product Description	3	Timing Belt Tensioning	6
Specifications	3	Timing Belt Replacement	6
Installation	4	Drive or Driven Pulley Replacement	7
Required Tools	4	Gearmotor Replacement	7
Mounting	4	Service Parts	9
		Return Policy	10

Warnings – General Safety

	WARNING	
<p>The safety alert symbol, black triangle with white exclamation, is used to alert you to potential personal injury hazards.</p>		

		WARNING
<p>Gearmotors may be HOT. DO NOT TOUCH Gearmotors.</p>		

		DANGER
<p>Climbing, sitting, walking or riding on conveyor will cause severe injury. KEEP OFF CONVEYORS.</p>		

		WARNING
<p>Exposed moving parts can cause severe injury. LOCK OUT POWER before removing guards or performing maintenance.</p>		

		DANGER
<p>DO NOT OPERATE CONVEYORS IN AN EXPLOSIVE ENVIRONMENT.</p>		

		WARNING
<p>Dorner cannot control the physical installation and application of conveyors. Taking protective measures is the responsibility of the user.</p> <p>When conveyors are used in conjunction with other equipment or as part of a multiple conveyor system, CHECK FOR POTENTIAL PINCH POINTS and other mechanical hazards before system start-up.</p>		

		DANGER
<p>Hazardous voltage will cause severe injury or death. LOCK OUT POWER BEFORE WIRING.</p>		

Introduction

IMPORTANT: Some illustrations may show guards removed. Do NOT operate equipment without guards.

Upon receipt of shipment:

- Compare shipment with packing slip. Contact factory regarding discrepancies.
- Inspect packages for shipping damage. Contact carrier regarding damage.
- Accessories may be shipped loose. See accessory instructions for installation.

Dorner 2100 Series conveyors are covered by the following patent numbers: 5131529, 5174435, and corresponding patents and patent applications in other countries.

Dorner 4100 Series conveyors are covered by patent number 3923148 and corresponding patents and patent applications in other countries.

Dorner 6100 Series conveyors are covered by patent number 5174435 and corresponding patents and patent applications in other countries.

Dorner's Limited Warranty applies.

Dorner reserves the right to make changes at any time without notice or obligation.

Product Description

Refer to Figure 1 for typical components.

Typical Components	
A	Conveyor
B	Mounting Bracket
C	Gearmotor
D	Belt Tensioner
E	Cover
F	Timing Belt
G	Drive Pulley
H	Driven Pulley

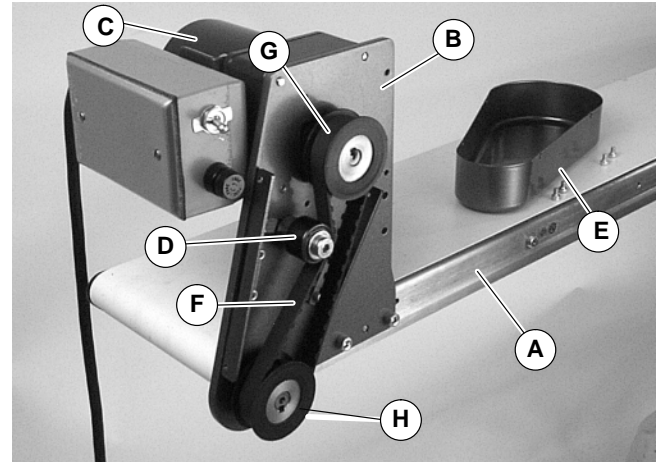

Figure 1

Specifications

Gearmotor Mounting Package Models:

Example:

2 M T P L W W A - 32 32

- 2 = 2100 Series Conveyor
- 4 = 4100 Series Conveyor
- 6 = 6100 Series Conveyor
- Language Code = U.S. English
- Mount Style = Top Mount
- Output Shaft Type = Parallel Shaft
- Gearmotor Type: L = Fixed Speed, V = Variable Speed
- Conveyor Width Reference*
- Mount Position = A, B, C or D (see detail to the right)
- Belt Type: - = flat belt, A through J = cleated belt
- Drive Pulley (see Tables 2 & 3)
- Driven Pulley (see Tables 2 & 3)

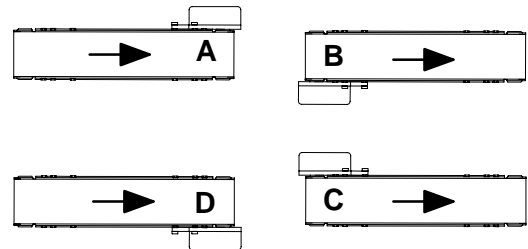

* See "Ordering and Specifications" Catalog for details.

Table 1: Gearmotor Specifications

	Single Phase	DC Variable Speed
Output Power	0.03 hp (0.025 kw)	0.06 hp (0.04 kw)
Input Voltage	115 Volts A.C.	130 Volts D.C.
Input Frequency	60 Hz	N/A
Full Load Amperes	0.49 Amperes	0.48 Amperes
Gearmotor Ratios	15:1 and 36:1	18:1 and 60:1

Specifications

Table 2: Belt Speeds for Light Load Fixed Speed Parallel Shaft 60 Hz Gearmotors

Gearmotors				Belt Speed		Drive Pulley	Driven Pulley
Part Number	RPM	In-lb	N-m	Ft/min	M/min		
62M036PL411FN	42	36	4.1	7	2.1	19	32
62M036PL411FN	42	36	4.1	12	3.7	32	32
62M036PL411FN	42	36	4.1	17	5.2	32	22
62M036PL411FN	42	36	4.1	24	7.3	44	22
62M015PL411FN	100	15	1.7	29	8.8	32	32
62M015PL411FN	100	15	1.7	41	12.5	32	22

Table 3: Belt Speeds for Light Load Variable Speed Parallel Shaft DC Gearmotors

Gearmotors				Belt Speed		Drive Pulley	Driven Pulley
Part Number	RPM	In-lb	N-m	Ft/min	M/min		
62M060PLD3DEN	42	65	7.4	0.8 – 7	0.3 – 2.2	19	32
62M060PLD3DEN	42	65	7.4	1.4 – 12	0.4 – 3.6	32	32
62M018PLD3DEN	139	21	2.4	4.8 – 40	1.5 – 12	32	32
62M018PLD3DEN	139	21	2.4	7 – 58	2.1 – 18	32	32

NOTE: 8 – 24 in (203 – 610 mm) wide conveyors with light load drives should be limited to 96 in (2438 mm) length.

NOTE: For belt speed other than those listed, contact factory for details.

Installation



Required Tools

- Hex key wrenches:
2.5 mm, 3 mm, 5 mm
- Straight edge
- Torque wrench

Installation Component List

I	Top Mount Assembly
J	Driven Pulley
K	Cover
L	M4 Socket Head Screws (4x)
M	Timing Belt
N	Key
O	M6 Socket Head Screws (2x)

Mounting

		<h2>WARNING</h2>
	<p>Exposed moving parts can cause severe injury. LOCK OUT POWER before removing guards or performing maintenance.</p>	

1. Typical components (Figure 2)

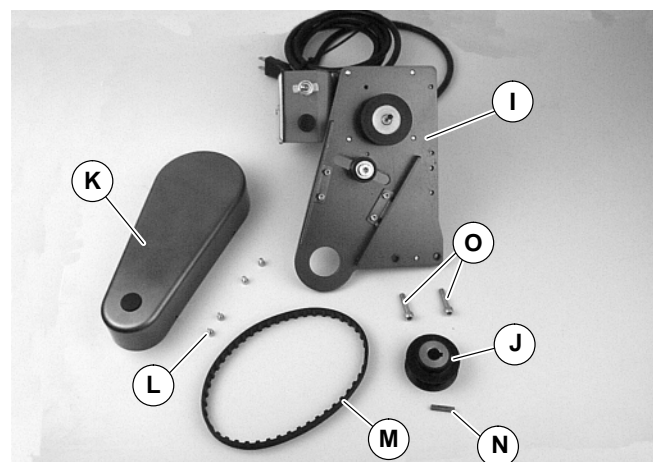

Figure 2

NOTE: 6100 conveyor shown, 2100 & 4100 similar.

2. Locate drive output shaft (P of Figure 3) and remove two (2) screws (Q).

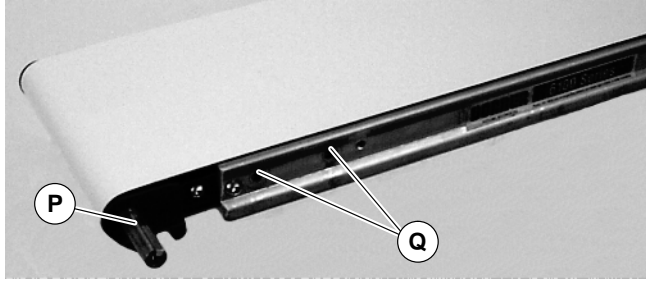

Figure 3

3. Attach mount assembly (I of Figure 4) with screws (O). Tighten screws to 80 in-lb (9 Nm).

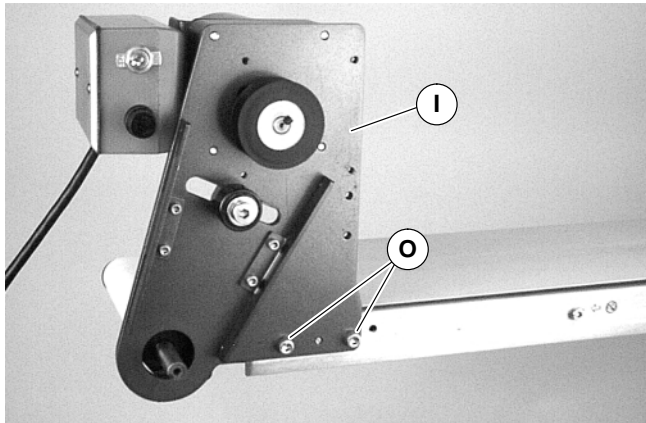
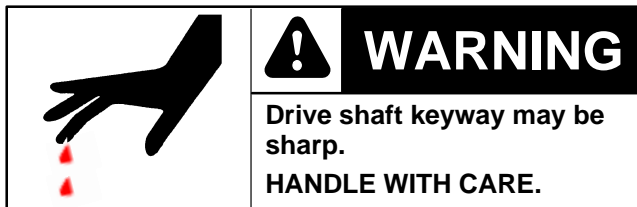

Figure 4



4. Install key (N of Figure 5).

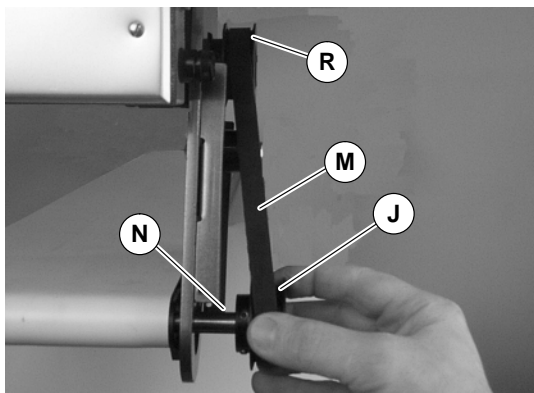

Figure 5

5. Wrap timing belt (M) around driven pulley (J) and drive pulley (R). Install driven pulley (J) onto conveyor shaft.

6. Using a straight edge (S of Figure 6), align driven pulley (J) with drive pulley (R). Tighten driven pulley set screws (T).

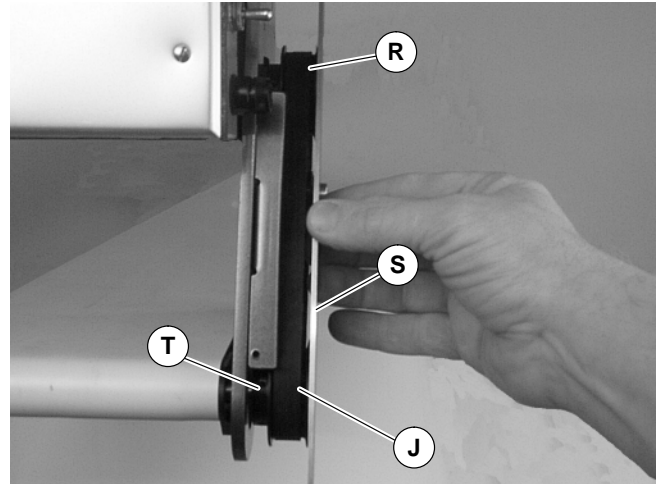

Figure 6

7. Depending on direction of conveyor belt travel (1 or 2 of Figure 7), position timing belt tensioner (U) as shown. Tension timing belt to obtain 1/8" (3 mm) deflection at timing belt mid-point (V). Tighten tensioner screw to 106 in-lb (12 Nm).

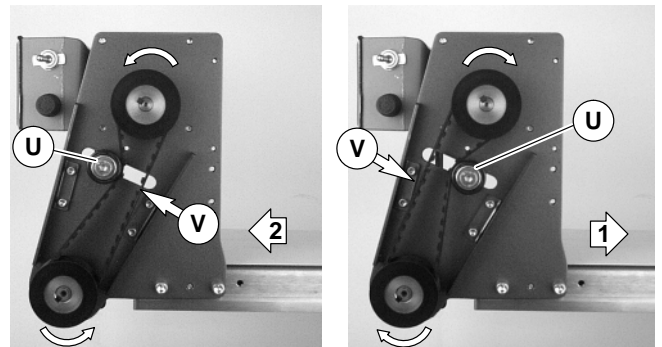

Figure 7

8. Install cover (K of Figure 8) with four (4) screws (L). Tighten to 35 in-lb (4 Nm).

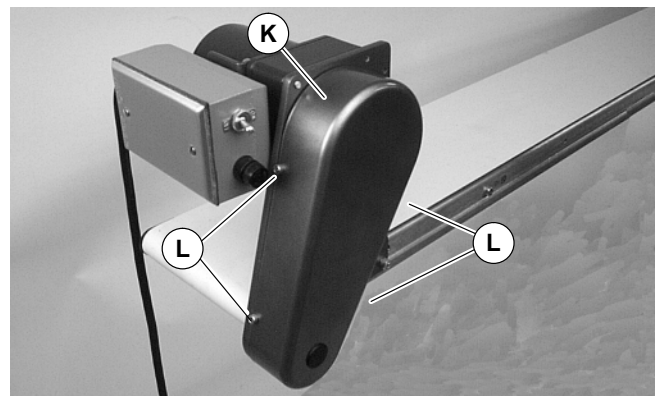

Figure 8

Preventive Maintenance and Adjustment

Required Tools

- Hex key wrenches:
2.5 mm, 3 mm, 5 mm
- Straight edge
- Screwdriver (for terminal box screws)
- Torque wrench

Timing Belt Tensioning

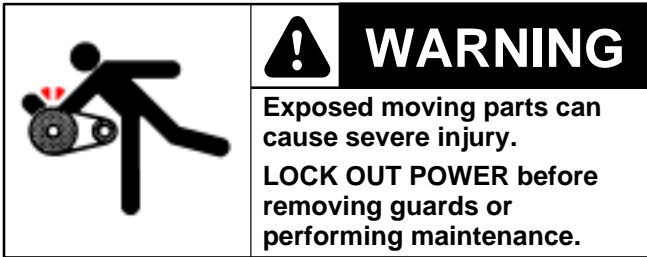

1. Remove four (4) screws (L of Figure 9) and remove cover (K).

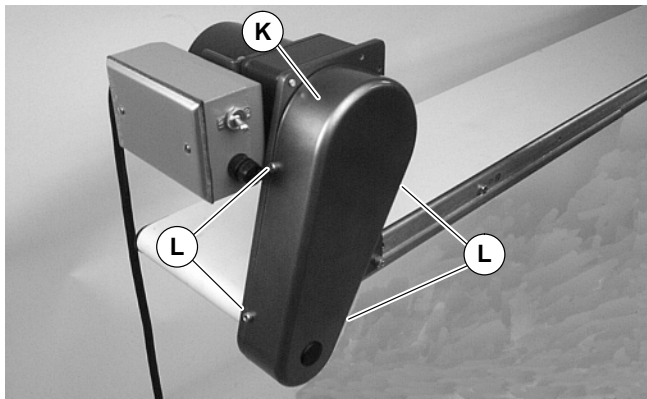

Figure 9

2. Loosen tensioner (U of Figure 10).

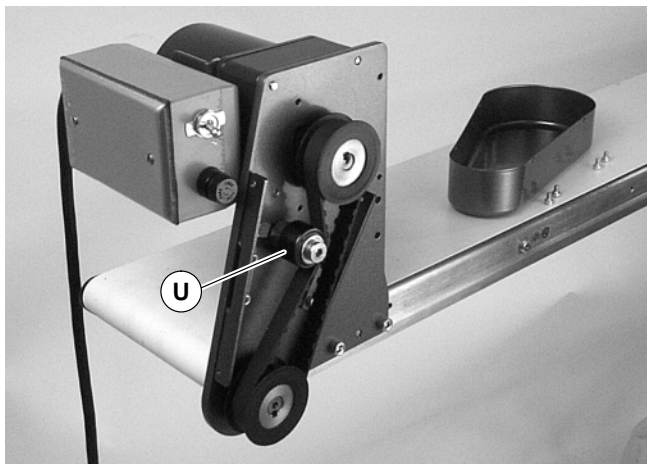

Figure 10

3. Depending on direction of conveyor belt travel (1 or 2 of Figure 11), position timing belt tensioner (U) as shown. Tension timing belt to obtain 1/8" (3 mm)

deflection for 1 lb (456) grams of force at timing belt mid-point (V). Tighten tensioner screw to 106 in-lb (12 Nm).

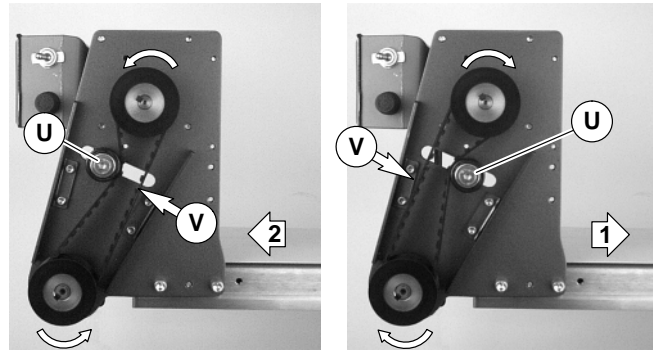
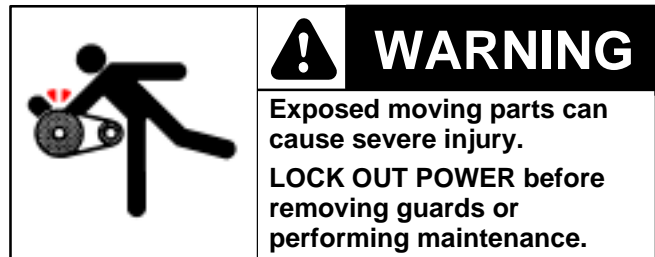

Figure 11

4. Install cover (K of Figure 9) with four (4) screws (L). Tighten screws to 35 in-lb (4 Nm).

Timing Belt Replacement



1. Remove four (4) screws (L of Figure 9) and remove cover (K).
2. Loosen tensioner (U of Figure 10).
3. Remove timing belt (M of Figure 12).

NOTE: If timing belt does not slide over pulley flange, loosen driven pulley set screws (T of Figure 12) and remove pulley with belt. For re-installation, see steps 5 through 8 on page 5.

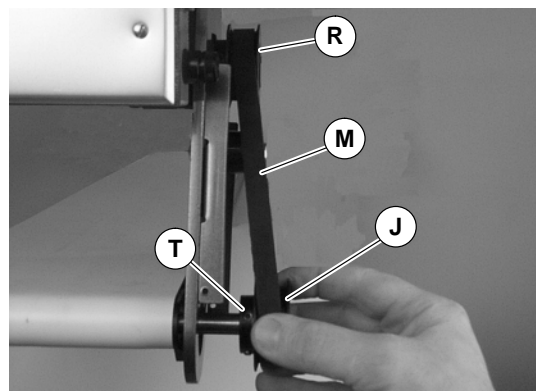

Figure 12

4. Install new timing belt.

Preventive Maintenance and Adjustment

- Depending on direction of conveyor belt travel (1 or 2 of Figure 11), position timing belt tensioner (U) as shown. Tension timing belt to obtain 1/8" (3 mm) deflection for 1 lb (456 grams) of force at timing belt mid-point (V). Tighten tensioner screw to 106 in-lb (12 Nm).
- Install cover (K of Figure 9) with four (4) screws (L). Tighten screws to 35 in-lb (4 Nm).

Drive or Driven Pulley Replacement

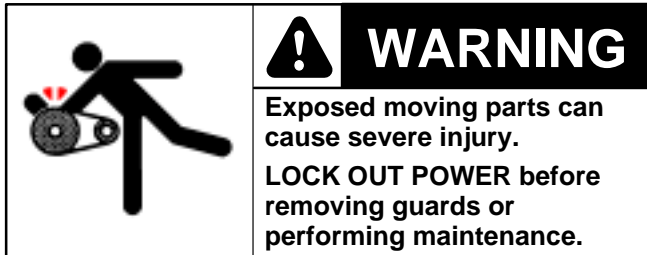

- Complete steps 1 through 3 of "Timing Belt Replacement" section on page 6.
- Loosen set screws and remove drive or driven pulley.

NOTE: If drive pulley (R of Figure 13) is replaced, wrap timing belt around drive pulley and complete step 3.

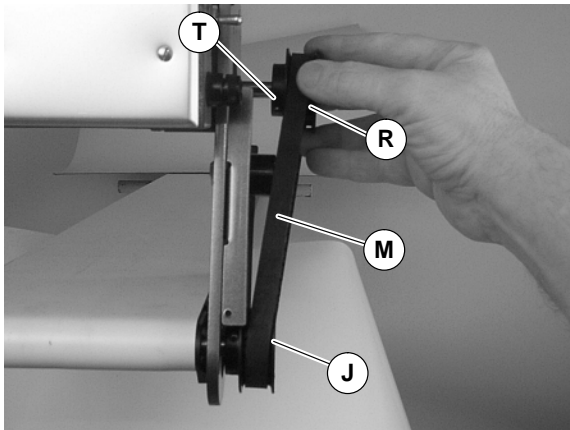
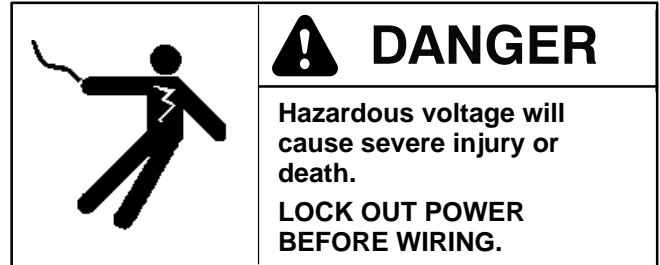

Figure 13

- Complete steps 5 through 8 of "Installation" section on page 5.

Gearmotor Replacement



- For single phase motor, unplug power cord from outlet.
- For DC variable speed motor, unplug motor cord at disconnect (W of Figure 14).

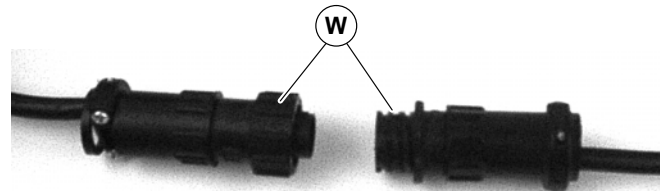

Figure 14

- Remove four (4) screws (L of Figure 9) and remove cover (K).
- Loosen tensioner (U of Figure 10).

Preventive Maintenance and Adjustment

5. Remove timing belt (M of Figure 15).

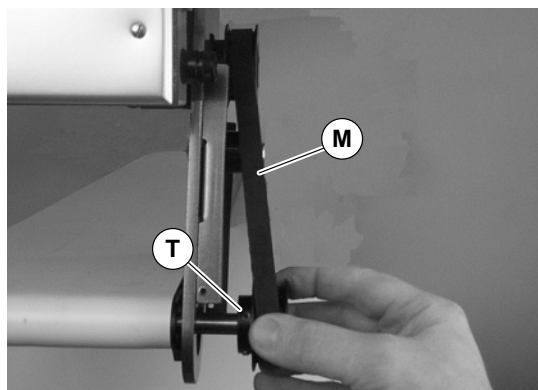

Figure 15

NOTE: If timing belt does not slide over pulley flange, loosen driven pulley set screws (T of Figure 15) and remove pulley with belt (M). For re-installation, see steps 5 through 8 on page 5.

6. Loosen two (2) set screws (T of Figure 16). Remove drive pulley (R).

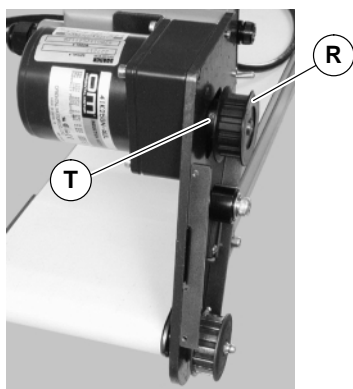

Figure 16

7. Remove four (4) screws (X) and detach gearmotor.

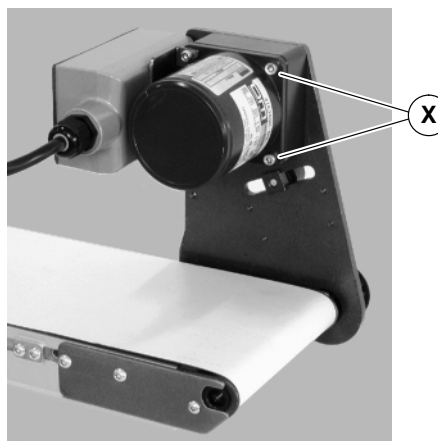

Figure 17

8. Mount new gearmotor with four (4) screws (X). Tighten to 45 in-lb (5 Nm).
9. Replace drive pulley (R of Figure 16) and tighten set screws (T).
10. Complete steps 5 through 8 of “Installation” section on page 5.
11. Replace wiring:
- For a single phase motor, reverse step 1 on page 7.
 - For DC variable speed motor, reverse step 2 on page 7.

NOTE: For replacement parts other than those shown on this page, contact an authorized Dorner Service Center or the factory.

Item	Part No.	Part Description
1	62M036PL411FN	Gearmotor, 0.03 hp, 115 Volts, 42 RPM, 60 Hz, 1-Phase, 36:1
	62M015PL411FN	Gearmotor, 0.03 hp, 115 Volts, 100 RPM, 60 Hz, 1-Phase, 15:1
	62M060PLD3DEN	Gearmotor, 0.06 hp, 130 Volts, 42 RPM, DC, 60:1
	62M018PLD3DEN	Gearmotor, 0.06 hp, 130 Volts, 139 RPM, DC, 18:1
2	814-107	Timing Belt, 15mm W x 360mm L
	814-103	Timing Belt, 15mm W x 385mm L
	814-100	Timing Belt, 15mm W x 400mm L
	814-096	Timing Belt, 15mm W x 425mm L
	814-104	Timing Belt, 15mm W x 450mm L
	814-105	Timing Belt, 15mm W x 460mm L
	814-065	Timing Belt, 15mm W x 475mm L
	814-112	Timing Belt, 15mm W x 495mm L
	814-101	Timing Belt, 15mm W x 500mm L
814-108	Timing Belt, 15mm W x 520mm L	
3	814-064	Timing Belt, 15mm W x 535mm L
4	450383MP	Drive Pulley, 19 Tooth, 10mm Bore
	450384MP	Drive Pulley, 22 Tooth, 10mm Bore
	450385MP	Drive Pulley, 28 Tooth, 10mm Bore
	450386MP	Drive Pulley, 32 Tooth, 10mm Bore
	450387MP	Drive Pulley, 44 Tooth, 10mm Bore
	450365P	Drive Pulley, 19 Tooth, 0.5" Bore
	450366P	Drive Pulley, 22 Tooth, 0.5" Bore
	450367P	Drive Pulley, 28 Tooth, 0.5" Bore
	450368P	Drive Pulley, 32 Tooth, 0.5" Bore
450369P	Drive Pulley, 44 Tooth, 0.5" Bore	
5	980422M	Key, 4mm x 22mm, 10mm Bore
	912-052	Key, 1/8" x 5/8", 1/2" Bore
6	450365MP	Driven Pulley, 19 Tooth
	450366MP	Driven Pulley, 22 Tooth
	450367MP	Driven Pulley, 28 Tooth
	450368MP	Driven Pulley, 32 Tooth
7	980422M	Key, 4mm x 22mm

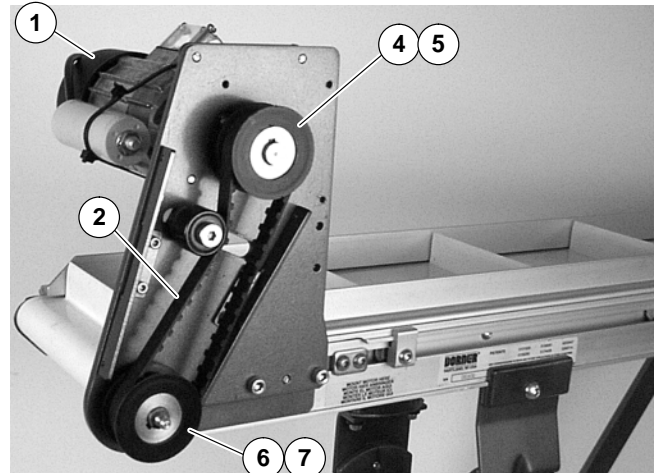

Figure 18

Return Policy

No returns will be accepted without prior written factory authorization. When calling for authorization, please have the following information ready for the Dorner Factory representative or your local distributor:

1. Name and address of customer.
2. Item(s) being returned.
3. Reason for return.
4. Customer's original order number used when ordering the item(s).
5. Dorner or distributor invoice number.

A representative will discuss action to be taken on the Returned items and provide a Returned Goods Authorization Number to reference.

There will be a 15% restocking charge on all new items returned for credit where Dorner was not at fault. These will not be accepted after 60 days from original invoice date. The restocking charge covers inspection, cleaning, disassembly, and reissuing to inventory.

If a replacement is needed prior to evaluation of returned item, a purchase order must be issued. Credit (if any) is issued only after return and evaluation is complete.

Dorner has representatives throughout the world. Feel free to contact Dorner for the name of your local representative. Our technical sales and service staff will gladly help with your questions on Dorner products.

For a copy of Dorner's Limited Warranty, contact factory, distributor, service center or visit our website at www.dorner.com

DORNER[®]

Dorner Mfg. Corp. reserves the right to change or discontinue products without notice. All products and services are covered in accordance with our standard warranty. All rights reserved. © Dorner Mfg. Corp. 2000

DORNER MFG. CORP.

975 Cottonwood Ave. PO Box 20
Hartland, WI 53029-0020 USA

USA

TEL 1-800-397-8664 (USA)

FAX 1-800-369-2440 (USA)

Outside the USA:

TEL 1-262-367-7600, FAX 1-262-367-5827

DORNER

Arnold-Sommerfeld-Ring 2
D-52499 Baesweiler

Germany

TEL (02401) 80 52 90

FAX (02401) 80 52 93

Internet: www.dorner.com