

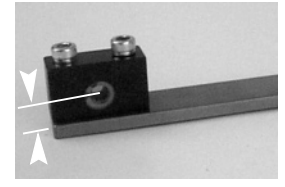

Typical Two Conveyor Gang Drive Mount

WARNING

To prevent injury, make sure all electrical power sources have been disconnected and locked-out before you perform any assembly or adjustments. NEVER operate equipment without guards or other protective devices properly secured in place. In addition, keyway on conveyor drive shaft may be sharp! Exercise caution when mounting the flex coupling.

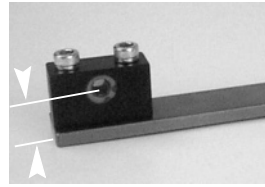

Step 1: Verify that factory-configured bearing support assembly is correct for your conveyor model - 2100 setup (left) and 4100 or 6100 setup (right).

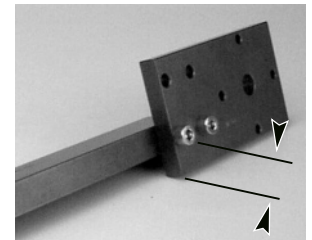
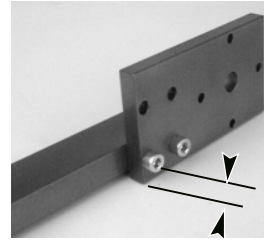

Step 2: Verify that factory-configured gearmotor support assembly is correct for your conveyor model - 2100 setup (left) and 4100 or 6100 setup (right).

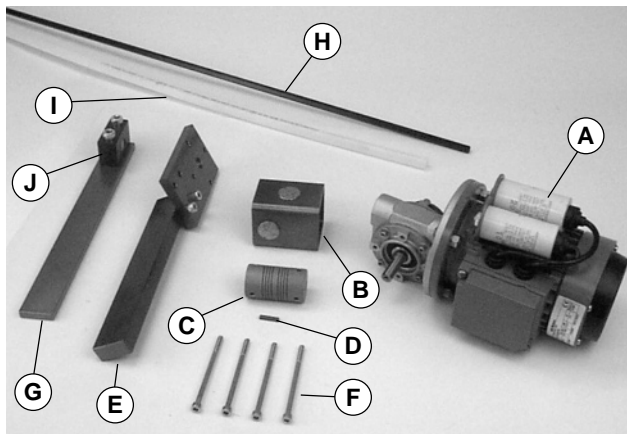

Step 1: Layout the gearmotor assembly and all loose parts as shown.

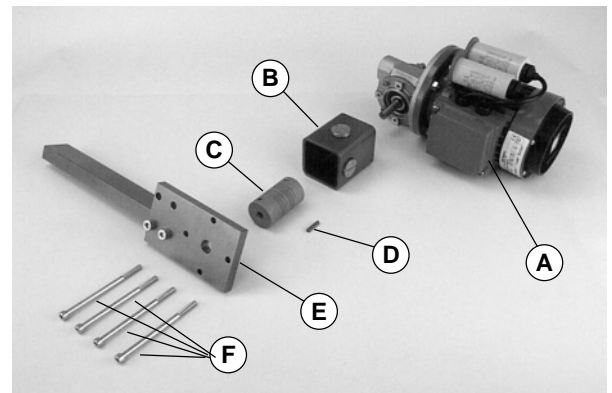

Step 3: Build gearmotor assembly as shown. Tighten screws (F) with 5.6 Nm of torque.

NOTE: Refer to the following drawing for alternate motor positions.

Illustration References

- A Gearmotor Assembly
- B Guard Tube (with Plugs installed)
- C Flex Coupling (807-996)
- D Square Key, 5 mm (980540M)
- E Gearmotor Support Assembly
- F Guard Mounting Screws, (4) M6 x 100 mm, Socket Head
- G Bearing Support Assembly
- H Hexagon Shaft - 1220 mm (23-24)
- I Shaft Cover - 1524 mm (807-967)
- J Bearing Block (450092)

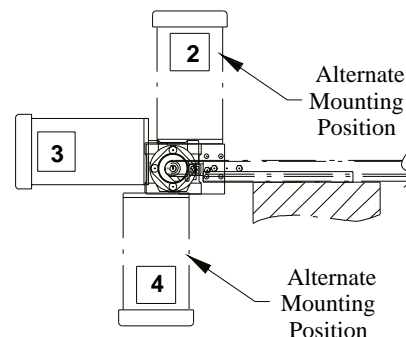

NOTE: Position "4" may reduce gear reducer oil seal life.

<continued on next page>

63U01 Gang Drive Mounting

!

WARNING

!

To prevent injury, both gearmotor & bearing support assemblies must be anchored to their mounting surfaces. Customer is responsible for method and means of attachment.

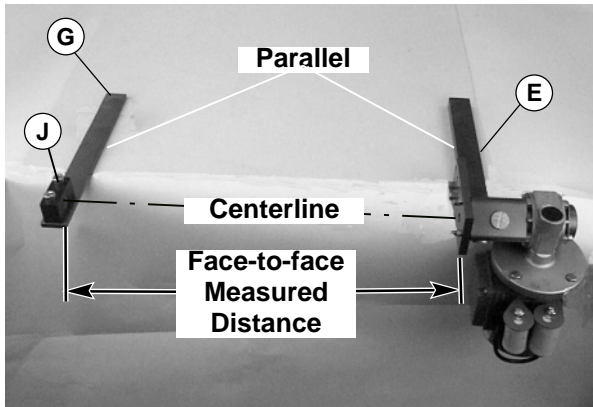

Step 4: Attach the gearmotor support assembly (E) and bearing support assembly (G) to their respective mounting surfaces.

NOTE: Mounting holes are not provided. Be sure that the two assemblies are parallel and the center-line of coupling matches the center-line of the bearing block.

Step 5: Measure and record the distance from the face of the motor mounting plate to the face of bearing block (J) as shown.

Step 6: Cut the hex shaft (H) to the measured distance plus 54 mm.

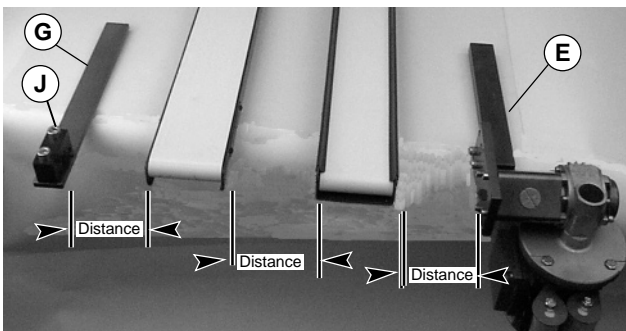

Step 7: Properly align and position conveyors between gearmotor support assembly (E) and bearing support assembly (G) as required. Do not secure the conveyors to the mounting surface.

Step 8: Measure and record the distances between the bearing block, conveyors, and the motor mounting plate.

Step 9: Cut the shaft cover (I) into pieces to match each measured distance minus 1.5 mm.

!

WARNING

!

Shaft covers must be installed to help prevent injury from accidental contact with rotating hex shaft. Purchase additional shaft cover (807-967) when re-configuring conveyor setup.

Step 10: Remove the bearing block (J).

Step 11: Remove access plugs from guard tube (B).

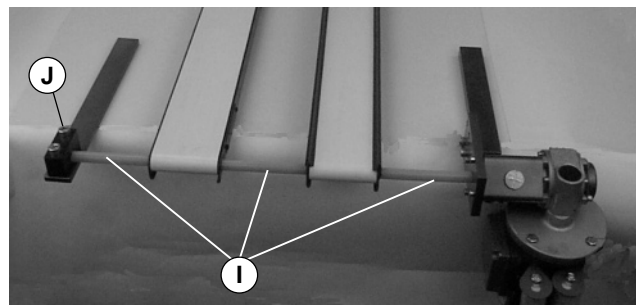

Step 12: Slide hex shaft through conveyors and into flex coupling while placing shaft cover (I) pieces between components.

Step 13: Replace bearing block (J) and secure it with 47.5 Nm of torque.

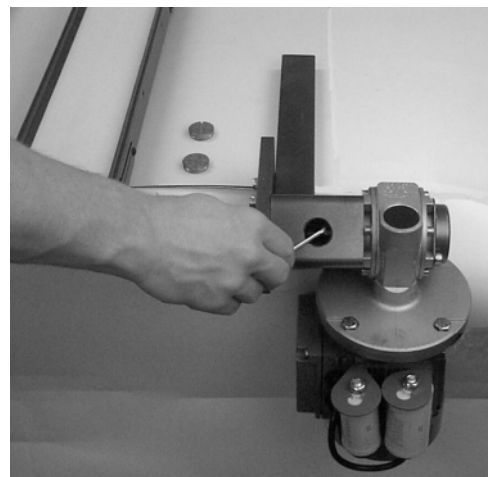

Step 14: Secure the coupling to hex shaft by tightening both set screws. Visually inspect coupling for correct alignment (equal gaps in coupling grooves). Replace access plugs.

DORNER®
 Dorner Mfg. Corp. reserves the right to change or discontinue products without notice. All products and services are covered in accordance with our standard warranty. All rights reserved. © Dorner Mfg. Corp. 1999

DORNER MFG. CORP.
 580 Industrial Drive, PO Box 20
 Hartland, WI 53029-0020 USA
USA
 TEL 1-800-397-8664 (USA)
 FAX 1-800-369-2440 (USA)
 Outside the USA:
 TEL 1-414-367-7600, FAX 1-414-367-5827

DORNER
 Arnold-Sommerfeld-Ring 2
 D-52499 Baesweiler
Germany
 TEL (02401) 80 52 90
 FAX (02401) 80 52 93