

### 2100, 2200, 4100, 6200, MPB Series Side Mount Drive Package for Light Load 60 Hz Gearmotors

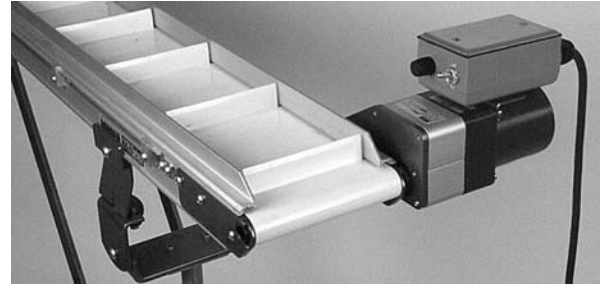
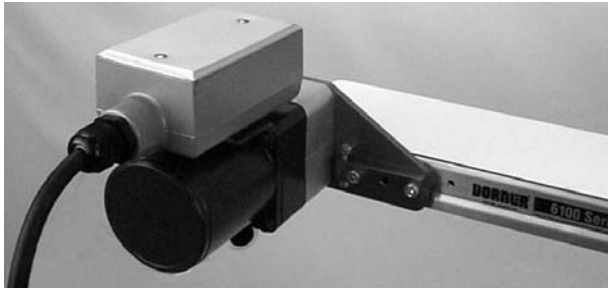

## Table of Contents

Warnings – General Safety .....	2	Preventative Maintenance & Adjustment .....	6
Introduction .....	2	Required Tools .....	6
Product Description .....	3	Timing Belt Tensioning .....	6
Specifications .....	3	Timing Belt Replacement .....	6
Installation .....	4	Drive or Driven Pulley Replacement .....	7
Required Tools .....	4	Gearmotor Replacement .....	7
Mounting .....	4	Service Parts .....	8
		Return Policy .....	10

# Warnings – General Safety

	<b>WARNING</b>	
<p>The safety alert symbol, black triangle with white exclamation, is used to alert you to potential personal injury hazards.</p>		

	<b>WARNING</b>
<p>Gearmotors may be HOT. <b>DO NOT TOUCH</b> Gearmotors.</p>	

	<b>DANGER</b>
<p>Climbing, sitting, walking or riding on conveyor will cause severe injury. <b>KEEP OFF CONVEYORS.</b></p>	

	<b>WARNING</b>
<p>Exposed moving parts can cause severe injury. <b>LOCK OUT POWER</b> before removing guards or performing maintenance.</p>	

	<b>DANGER</b>
<p><b>DO NOT OPERATE CONVEYORS IN AN EXPLOSIVE ENVIRONMENT.</b></p>	

	<b>WARNING</b>
<p>Dorner cannot control the physical installation and application of conveyors. Taking protective measures is the responsibility of the user.</p> <p>When conveyors are used in conjunction with other equipment or as part of a multiple conveyor system, <b>CHECK FOR POTENTIAL PINCH POINTS</b> and other mechanical hazards before system start-up.</p>	

	<b>DANGER</b>
<p>Hazardous voltage will cause severe injury or death. <b>LOCKOUT POWER BEFORE WIRING.</b></p>	

## Introduction

**IMPORTANT:** Some illustrations may show guards removed. Do NOT operate equipment without guards.

Upon receipt of shipment:

- Compare shipment with packing slip. Contact factory regarding discrepancies.
- Inspect packages for shipping damage. Contact carrier regarding damage.
- Accessories may be shipped loose. See accessory instructions for installation.

Dorner 2100 Series conveyors are covered by the following patent numbers: 5131529, 5174435, and corresponding patents and patent applications in other countries.

Dorner 4100 Series conveyors are covered by patent number 3923148 and corresponding patents and patent applications in other countries.

Dorner 2200 & 6200 Series conveyors are covered by patent number 5174435 and corresponding patents and patent applications in other countries.

Dorner's Limited Warranty applies.

Dorner reserves the right to make changes at any time without notice or obligation.

Dorner has convenient, pre-configured kits of Key Service Parts for all conveyor products. These time saving kits are easy to order, designed for fast installation, and guarantee you will have what you need when you need it. Key Parts and Kits are marked in the Service Parts section of this manual with the Performance Parts Kits logo

# Product Description

Refer to Figure 1 for typical components.

Typical Components	
A	Conveyor
B	Mounting Bracket
C	Gearmotor
D	Belt Tensioner
E	Cover
F	Timing Belt
G	Drive Pulley
H	Driven Pulley

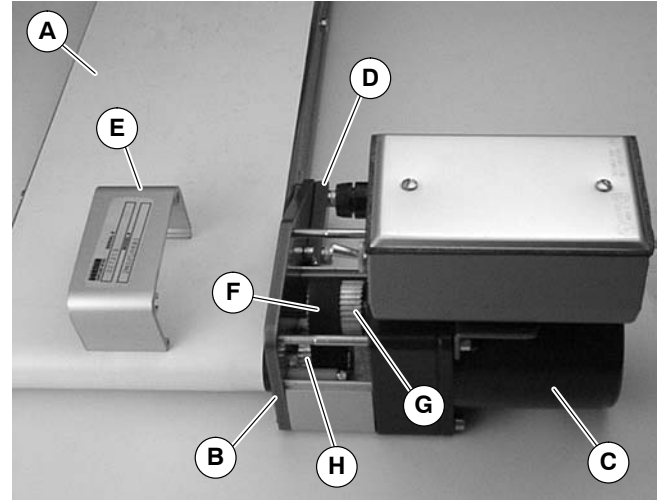
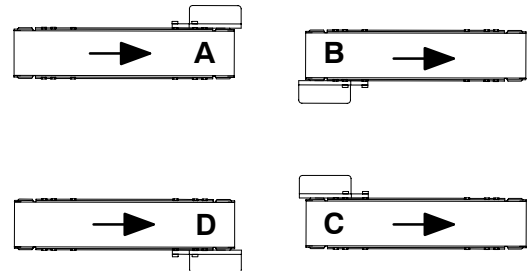
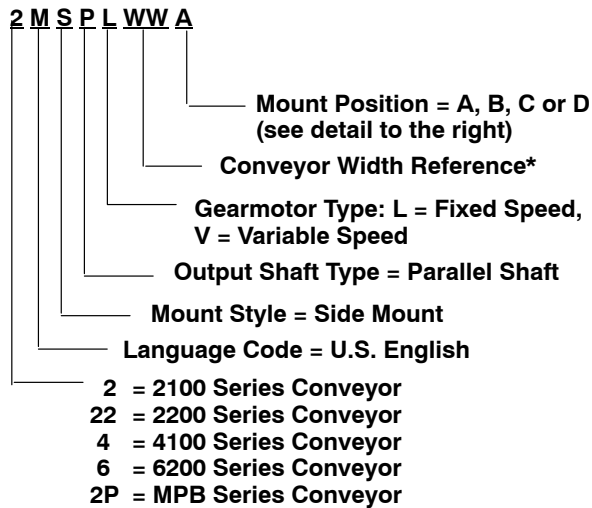

Figure 1

# Specifications

## Gearmotor Mounting Package Models:

Example:



\* See "Ordering and Specifications" Catalog for details.

Table 1: Gearmotor Specifications

	Single Phase	DC Variable Speed
Output Power	0.03 hp (0.025 kw)	0.06 hp (0.04 kw)
Input Voltage	115 Volts A.C.	130 Volts D.C.
Input Frequency	60 Hz	N/A
Full Load Amperes	0.49 Amperes	0.48 Amperes
Gearmotor Ratios	15:1 and 36:1	18:1 and 60:1

# Specifications

**Table 2: Belt Speeds for Light Load Fixed Speed Parallel Shaft 60 Hz Gearmotors on 2100, 2200, 4100 & 6200 Series Conveyors**

Gearmotors				Belt Speed	
Part Number	RPM	In-lb	N-m	Ft/min	M/min
62M036PL411FN	42	36	4.1	11.9	3.6
62M015PL411FN	100	15	1.7	28.6	8.7

**Table 3: Belt Speeds for Light Load Variable Speed Parallel Shaft DC Gearmotors on 2100, 2200, 4100 & 6200 Series Conveyors**

Gearmotors				Belt Speed	
Part Number	RPM	In-lb	N-m	Ft/min	M/min
62M060PLD3DEN	42	65	7.4	1.4–11.9	0.4–3.6
62M018PLD3DEN	139	21	2.4	4.8–39.7	1.5–12.1

**NOTE:** 8–24 in (203–610 mm) wide conveyors with light load drives should be limited to 96 in (2438 mm) length.

**NOTE:** For belt speed other than those listed, contact factory for details.

## Installation

### Required Tools

- Hex key wrenches:  
2 mm, 3 mm, 5 mm
- Torque wrench

### Mounting





**WARNING**

Exposed moving parts can cause severe injury.  
**LOCK OUT POWER** before removing guards or performing maintenance.

#### Installation Component List

- |   |                            |
|---|----------------------------|
| I | Side Mount Assembly        |
| J | Driven Pulley              |
| K | Top Cover                  |
| L | Tensioner Bar              |
| M | Timing Belt                |
| N | Key                        |
| O | M6 Socket Head Screws (2x) |

### 1. Typical components (Figure 2)

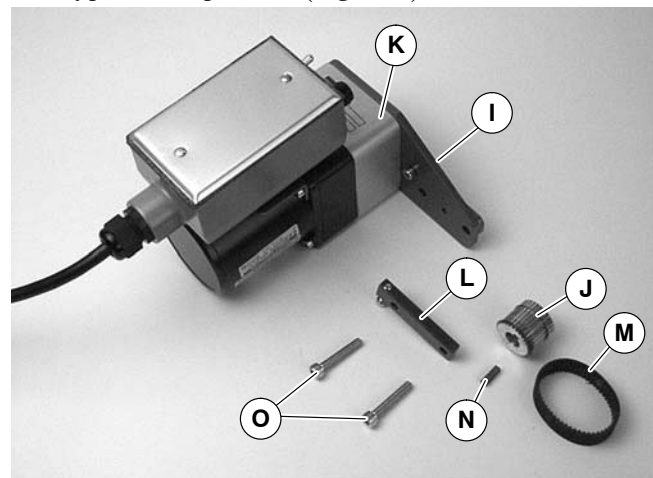

*Figure 2*

**NOTE:** 6100 conveyor shown, 2100 & 4100 similar.

2. Locate drive output shaft and remove two (2) screws (P of Figure 3).

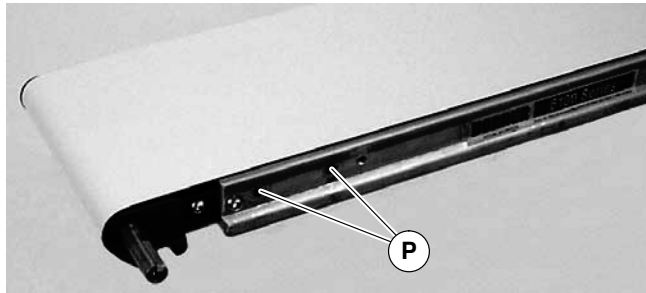

Figure 3

3. Loosen four (4) screws (Q of Figure 4). Detach mounting bracket (R).

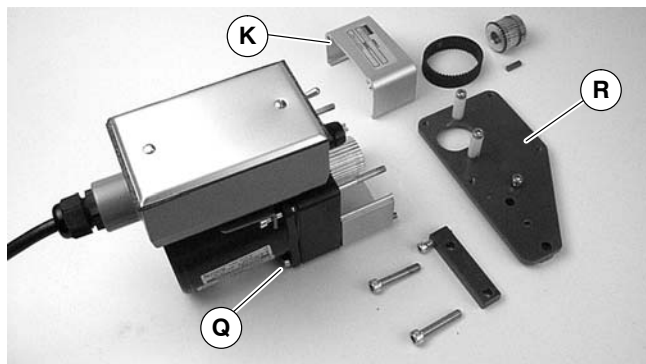

Figure 4

4. Remove two (2) top screws (Q) and remove top cover (K).
5. Attach mounting bracket (R of Figure 5) and tensioner bar (L) with screws (O). Hand-tighten screws (O).

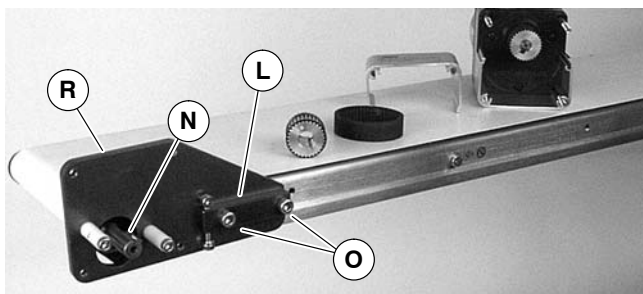

Figure 5



6. Install key (N of Figure 5).
7. Install driven pulley (J of Figure 6). Tighten two (2) set screws to 33 in-lb (3.7 Nm).

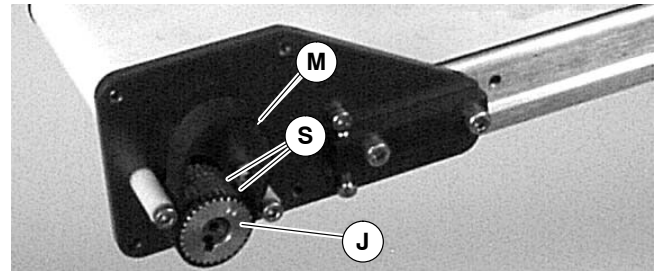

Figure 6

8. Place timing belt (M of Figure 6) over driven pulley (J) and between belt flanges (S).
9. Insert gearmotor drive pulley into timing belt. Mount assembly with two (2) bottom screws (Q of Figure 7). Tighten to 45 in-lb (5 Nm).

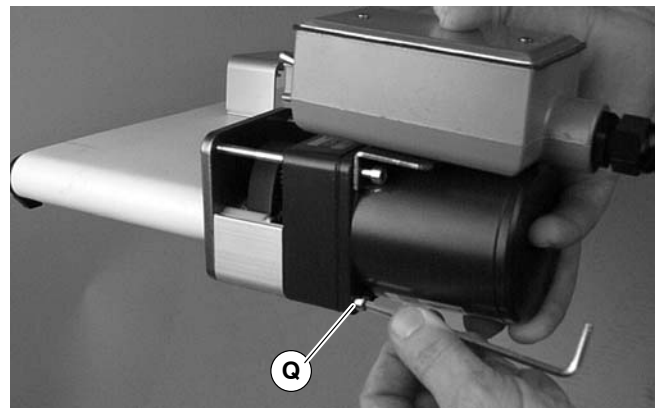

Figure 7

10. Insert top cover (K of Figure 8) into bottom cover. Attach top cover with two (2) top screws (Q). Tighten to 45 in-lb (5 Nm).

# Installation

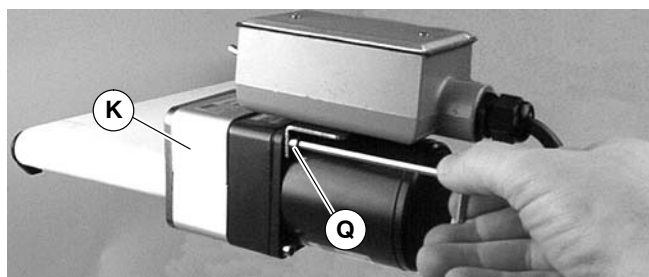

Figure 8

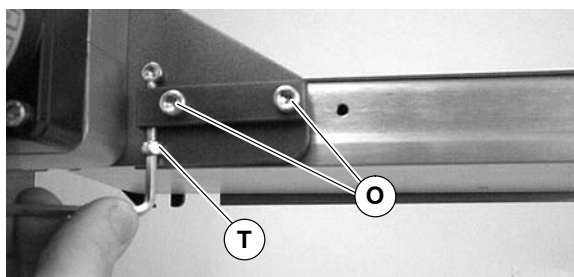

Figure 9

11. Tighten timing belt tensioner screw (T of Figure 9) to 15 in-lb (1.7 Nm).

12. Tighten screws (O) to 80 in-lb (9 Nm).

## Preventive Maintenance and Adjustment

### Required Tools

- Hex key wrenches:  
2 mm, 3 mm, 5 mm
- Torque wrench

### Timing Belt Tensioning

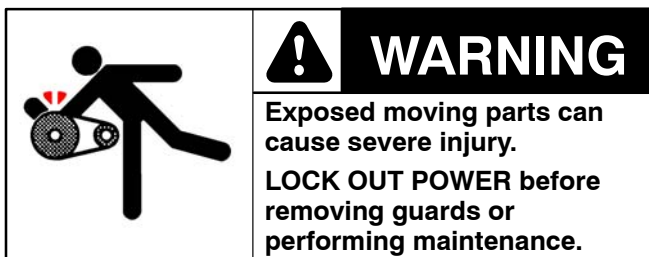

1. Loosen two (2) screws (O of Figure 10). Tighten timing belt tensioner screw (T) to 15 in-lb (1.7 Nm).

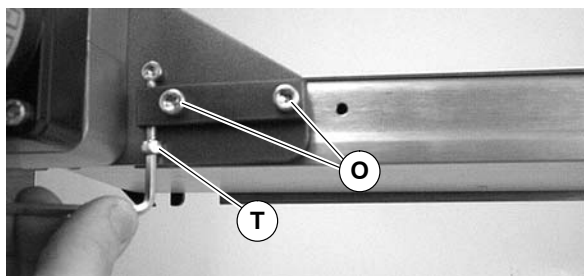
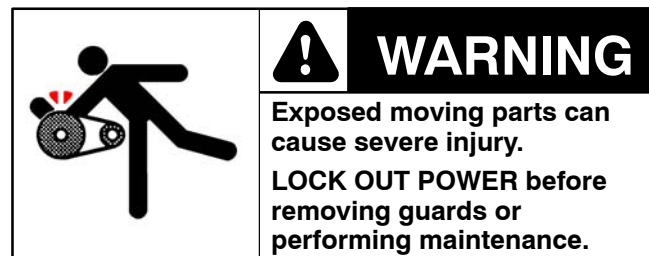

Figure 10

2. Tighten screws (O) to 80 in-lb (9 Nm).

### Timing Belt Replacement



1. Loosen two (2) screws (O of Figure 10).
2. Loosen timing belt tensioner screw (T).
3. Remove four (4) screws (Q of Figure 11). Remove gearmotor (U) and top cover (K).

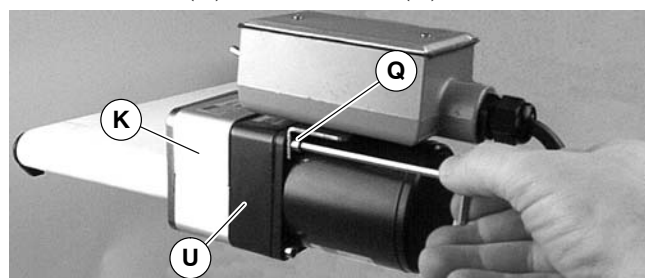

Figure 11

4. Remove old timing belt (M of Figure 12).

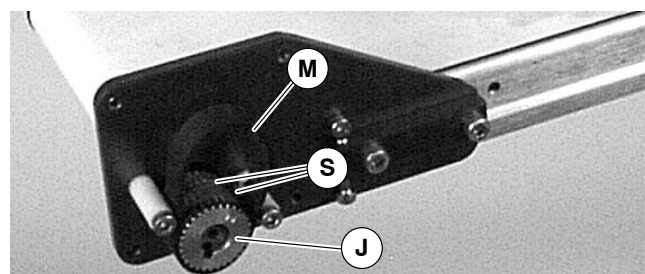

Figure 12

5. Place new timing belt (M) over driven pulley (J) and between belt flanges (S).

# Preventive Maintenance and Adjustment

6. Insert gearmotor drive pulley into timing belt. Mount assembly with two (2) bottom screws (Q of Figure 13). Tighten to 45 in-lb (5 Nm).

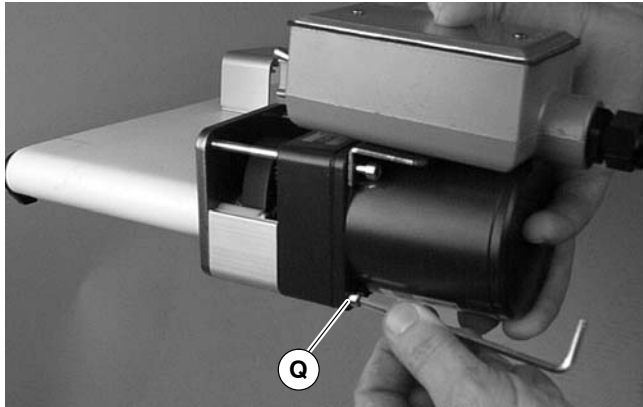

Figure 13

7. Insert top cover (K of Figure 11) into bottom cover. Mount assembly with two (2) top screws (Q). Tighten to 45 in-lb (5 Nm).
8. Tighten timing belt tensioner screw (T of Figure 10) to 15 in-lb (1.7 Nm).
9. Tighten screws (O) to 80 in-lb (9 Nm).

## Drive or Driven Pulley Replacement



1. Complete steps 1 through 4 of “Timing Belt Replacement” section on page 6.
2. Loosen set screws (V of Figure 14) and remove driven pulley (J) or drive pulley (W).

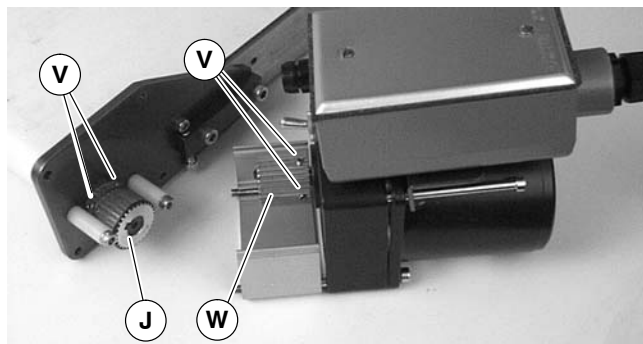
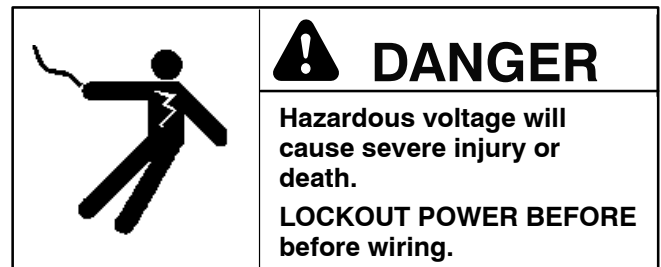

Figure 14

3. Replace drive or driven pulley. Tighten set screws to 33 in-lb (3.7 Nm).
4. Complete steps 5 through 9 of “Timing Belt Replacement” section beginning on page 6.

## Gearmotor Replacement



1. For single phase motor, unplug power cord from outlet.
2. For DC variable speed motor, unplug cord at disconnect (X of Figure 15):

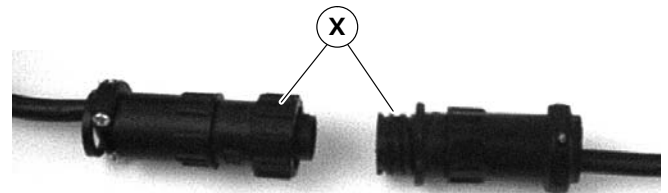

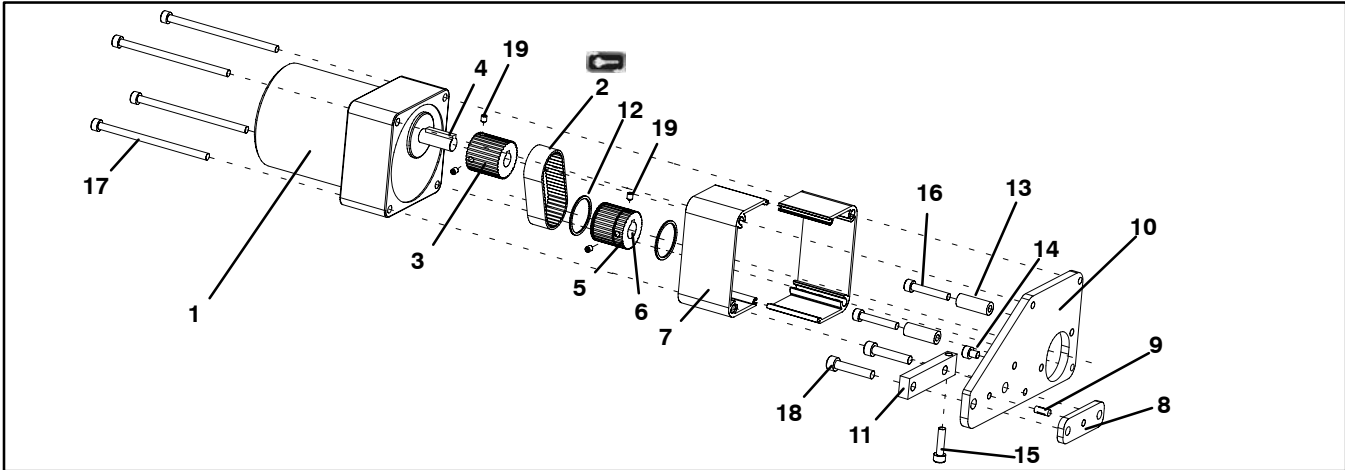



Figure 15

3. Remove four (4) screws (Q of Figure 11). Remove gearmotor (U) and top cover (K).
4. Loosen set screws (V of Figure 14) and remove drive pulley (W).
5. Replace drive pulley (W) on new gearmotor and tighten set screws (V) to 33 in-lb (3.7 Nm).
6. Complete steps 5 through 9 of “Timing Belt Replacement” section beginning on page 6.
7. Replace wiring:
  - For a single phase motor, reverse step 1.
  - For DC variable speed motor, reverse step 2.

# Service Parts

**NOTE:** For replacement parts other than those shown in this section, contact an authorized Dorner Service Center or the factory. Key Service Parts and Kits are identified by the Performance Parts Kits logo . Dorner recommends keeping these parts on hand.



Item	Part No.	Part Description
1	62M036PL411FN	Gearmotor, 0.03 hp, 115 Volts, 42 RPM, 60 Hz, 1-Phase, 36:1
	62M015PL411FN	Gearmotor, 0.03 hp, 115 Volts, 100 RPM, 60 Hz, 1-Phase, 15:1
	62M060PLD3DEN	Gearmotor, 0.06 hp, 130 Volts, 42 RPM, DC, 60:1
	62M018PLD3DEN	Gearmotor, 0.06 hp, 130 Volts, 139 RPM, DC, 18:1
2 	814-088	Timing Belt, 3mm x 15 mm
3	450078M	Drive Pulley, 1/2" Bore
	450076M	Drive Pulley, 10mm Bore
4	912-052	Key, 1/8" x 5/8", 1/2" Bore
	980422M	Key, 4mm x 22mm, 10mm Bore
5	450077M	Driven Pulley, 12 mm Bore
6	980422M	Driven Pulley Key, 4 mm x 22 mm

7	450087	Guard, Half, Light Duty Side Drive
8	450027M	Drive Spacer, Metric (6100 Only)
9	807-952	Groove Pin (6200 Only)
	450084M	Plate, Side Drive LD
10	450046M	Plate, Side Drive LD (2200 Only)
	450088M	Tensioning Bar, Side Drive
11	450088M	Tensioning Bar, Side Drive
12	807-954	Spiral Retaining Ring
13	807-973	Nylon Spacer
14	920506M	Socket Head Screw M5x6mm
15	920520M	Socket Head Screw M5x20mm
16	920530M	Socket Head Screw M5x30mm
17	920500M	Socket Head Screw M5x100mm
	920590M	Socket Head Screw M5x90mm
18	920630M	Socket Head Screw M6x30mm
19	970405M	Cup Set Screw M4x5mm





# Return Policy

Returns must have prior written factory authorization or they will not be accepted. Items that are returned to Dorner without authorization will not be credited nor returned to the original sender. When calling for authorization, please have the following information ready for the Dorner factory representative or your local distributor:

1. Name and address of customer.
2. Dorner part number(s) of Item(s) being returned.
3. Reason for return.
4. Customer's original order number used when ordering the item(s).
5. Dorner or distributor invoice number.

A representative will discuss action to be taken on the returned items and provide a Returned Goods Authorization number for reference.

There will be a return charge on all new undamaged items returned for credit where Dorner was not at fault. Dorner is not responsible for return freight on such items.

## **Conveyors and conveyor accessories**

Standard catalog conveyors	30%
MPB Series, cleated and specialty belt conveyors	50%
7400 & 7600 Series conveyors	non-returnable items
Engineered special products	case by case
Drives and accessories	30%
Sanitary stand supports	non-returnable items

## **Parts**

Standard stock parts	30%
MPB, cleated and specialty belts	non-returnable items

Returns will not be accepted after 60 days from original invoice date.

The return charge covers inspection, cleaning, disassembly, disposal and reissuing of components to inventory.

If a replacement is needed prior to evaluation of returned item, a purchase order must be issued. Credit (if any) is issued only after return and evaluation is complete.

Dorner has representatives throughout the world. Contact Dorner for the name of your local representative. Our Technical Sales, Catalog Sales and Service Teams will gladly help with your questions on Dorner products.

For a copy of Dorner's Warranty, contact factory, distributor, service center or visit our website at [www.dorner.com](http://www.dorner.com).

**For replacement parts, contact an authorized  
Dorner Service Center or the factory.**

# **DORNER<sup>®</sup>**

Dorner Mfg. Corp. reserves the right to change or discontinue products without notice. All products and services are covered in accordance with our standard warranty. All rights reserved. ©Dorner Mfg. Corp. 2000

## **DORNER MFG. CORP.**

975 Cottonwood Ave., PO Box 20  
Hartland, WI 53029-0020 USA

**USA**

**TEL 1-800-397-8664 (USA)**

**FAX 1-800-369-2440 (USA)**

**Internet: [www.dorner.com](http://www.dorner.com)**

**Outside the USA:**

**TEL 1-262-367-7600**

**FAX 1-262-367-5827**