

## 6100 Series Top Mount Drive Package for Heavy Load 90° Sanitary Gearmotors

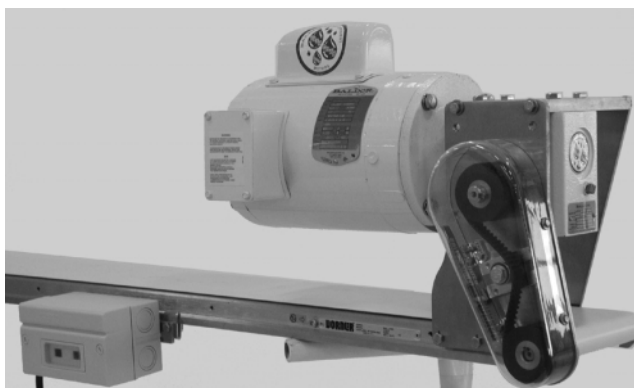



## Table of Contents



|                            |   |                                     |    |
|----------------------------|---|-------------------------------------|----|
| Warnings – General Safety  | 2 | Preventive Maintenance & Adjustment | 9  |
| Introduction               | 2 | Required Tools                      | 9  |
| Product Description        | 3 | Timing Belt Replacement             | 9  |
| Specifications             | 3 | Timing Belt Tensioning              | 10 |
| Installation               | 6 | Drive or Driven Pulley Replacement  | 11 |
| Required Tools             | 6 | Gear Reducer Replacement            | 11 |
| Mounting                   | 6 | Gear Motor Replacement              | 14 |
| Wiring                     | 8 | Service Parts                       | 15 |
| Single-phase Motor Starter | 8 | Return Policy                       | 16 |
| Three-phase Motor Starter  | 8 |                                     |    |
| VFD Controller             | 9 |                                     |    |

## Warnings – General Safety



|   |                |   |
|---|----------------|---|
|    | <b>WARNING</b> |  |
| <p>The safety alert symbol, black triangle with white exclamation, is used to alert you to potential personal injury hazards.</p> |                |   |



|   |   |                |
|---|---|----------------|
|  |  | <b>WARNING</b> |
| <p>Gearmotors may be HOT.<br/><b>DO NOT TOUCH</b> Gearmotors.</p>                 |   |                |

|  |   |               |
|--|---|---------------|
|                                 |  | <b>DANGER</b> |
| <p>Climbing, sitting, walking or riding on conveyor will cause severe injury.<br/><b>KEEP OFF CONVEYORS.</b></p> |   |               |

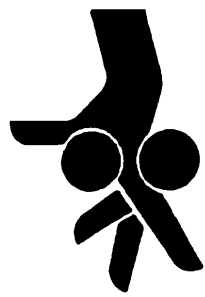
|  |   |                |
|--|---|----------------|
|    |  | <b>WARNING</b> |
| <p>Exposed moving parts can cause severe injury.<br/><b>LOCK OUT POWER</b> before removing guards or performing maintenance.</p> |   |                |

|   |   |               |
|---|---|---------------|
|  |  | <b>DANGER</b> |
| <p>Do NOT OPERATE CONVEYORS IN AN EXPLOSIVE ENVIRONMENT.</p>                      |   |               |

|   |   |                |
|---|---|----------------|
|    |  | <b>WARNING</b> |
| <p>Dorner cannot control the physical installation and application of conveyors. Taking protective measures is the responsibility of the user.<br/>When conveyors are used in conjunction with other equipment or as part of a multiple conveyor system, <b>CHECK FOR POTENTIAL PINCH POINTS</b> and other mechanical hazards before system start-up.</p> |   |                |

|   |  |               |
|---|--|---------------|
|                   |  | <b>DANGER</b> |
| <p>Hazardous voltage will cause severe injury or death.<br/><b>LOCKOUT POWER BEFORE WIRING.</b></p> |  |               |

## Introduction

**IMPORTANT:** Some illustrations may show guards removed. Do NOT operate equipment without guards.

Upon receipt of shipment:

- Compare shipment with packing slip. Contact factory regarding discrepancies.
- Inspect packages for shipping damage. Contact carrier regarding damage.

- Accessories may be shipped loose. See accessory instructions for installation.

Dorner 6100 Series conveyors are covered by patent number 5174435 and corresponding patents and patent applications in other countries.

Dorner's Limited Warranty applies.

Dorner reserves the right to make changes at any time without notice or obligation.

# Product Description

Refer to Figure 1 for typical components.

| Typical Components |                       |
|--------------------|-----------------------|
| A                  | Conveyor              |
| B                  | Mounting Bracket      |
| C                  | Gearmotor             |
| D                  | Timing Belt Tensioner |
| E                  | Cover                 |
| F                  | Timing Belt           |
| G                  | Drive Pulley          |
| H                  | Driven Pulley         |
| I                  | Motor Control         |

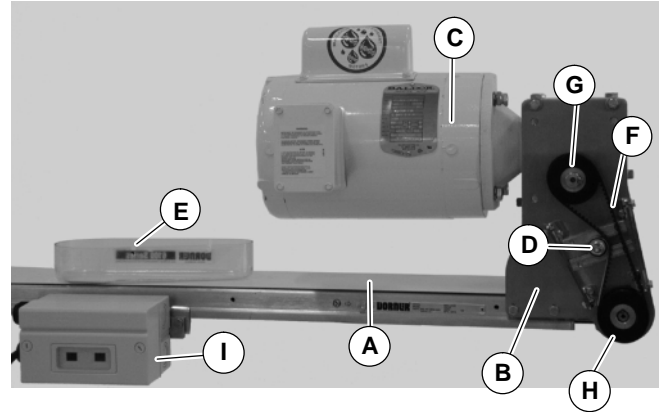

Figure 1

# Specifications

## Gearmotor Mounting Package Models:

Example:

6 M T L Z WW A1 - 3232

- Drive/Driven Pulleys (See tables 2, 3 & 4)
- “-” = Flat Belt (or add cleat type)
- Mount Position = A1, A2, D1 or D2 (see detail to the right)
- Conveyor Width Reference\*
- Gearmotor Type = Heavy Load, Sanitary
- Output Shaft Type L = Left Hand  
R = Right Hand
- Mount Style = Top Mount
- Language Code = U.S. English

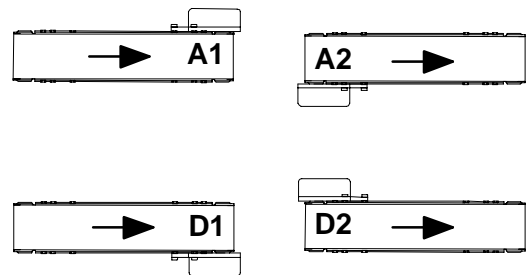

\* See “Ordering and Specifications” Catalog for details.

Table 1: Gearmotor Specifications

|                    | Single-Phase                         | Three-Phase            | VFD Variable Speed | DC Variable Speed |
|--------------------|--------------------------------------|------------------------|--------------------|-------------------|
| Output Power       | 0.5 hp (0.37 kw)                     |                        |                    | .33 hp (0.25 kw)  |
| Input Voltage      | 115 Volts A.C.                       | 208–230/460 Volts A.C. | 230 Volts A.C.     | 90 Volts D.C.     |
| Input Frequency    | 60 Hz                                | 60 Hz                  | 10 to 60 Hz        | N/A               |
| Full Load Amperes  | 6.8 Amperes                          | 1.8 – 1.6/.8 Amperes   | 1.6 Amperes        | 3.2 Amperes       |
| Gearmotor Ratios   | 5:1, 15:1 and 50:1                   |                        |                    |                   |
| Protection Ratings | IP55 for Gearmotor and Motor Starter |                        |                    |                   |

# Specifications

**Table 2: Heavy Load Fixed Speed 90° Sanitary 60 Hz Gearmotors**

| Gearmotors        |     |       |      | Belt Speed |       | Drive Pulley | Driven Pulley |
|-------------------|-----|-------|------|------------|-------|--------------|---------------|
| Part Number       | RPM | In-lb | N-m  | ft/min     | M/min |              |               |
| 62M050(r)Z4(vp)FN | 35  | 380   | 42.9 | 6          | 1.8   | 19           | 32            |
| 62M050(r)Z4(vp)FN | 35  | 380   | 42.9 | 10         | 3.0   | 32           | 32            |
| 62M050(r)Z4(vp)FN | 35  | 380   | 42.9 | 15         | 4.6   | 48           | 32            |
| 62M050(r)Z4(vp)FN | 35  | 380   | 42.9 | 22         | 6.7   | 48           | 22            |
| 62M015(r)Z4(vp)FN | 115 | 146   | 16.5 | 33         | 10.1  | 32           | 32            |
| 62M015(r)Z4(vp)FN | 115 | 146   | 16.5 | 49         | 14.9  | 48           | 32            |
| 62M015(r)Z4(vp)FN | 115 | 146   | 16.5 | 72         | 21.9  | 48           | 22            |
| 62M005(r)Z4(vp)FN | 345 | 55    | 6.2  | 99         | 30.2  | 32           | 32            |
| 62M005(r)Z4(vp)FN | 345 | 55    | 6.2  | 148        | 45.1  | 48           | 32            |
| 62M005(r)Z4(vp)FN | 345 | 55    | 6.2  | 169        | 51.1  | 48           | 28            |
| 62M005(r)Z4(vp)FN | 345 | 55    | 6.2  | 197        | 60.0  | 44           | 22            |
| 62M005(r)Z4(vp)FN | 345 | 55    | 6.2  | 215        | 65.5  | 48           | 22            |
| 62M005(r)Z4(vp)FN | 345 | 55    | 6.2  | 249        | 75.9  | 48           | 19            |

(vp) = Voltage and Phase  
 11 = 115 V, 1 phase  
 23 = 208 – 230/460 V, 3 phase  
 43 = 460V, 3 phase

(r) = Output Shaft Orientation  
 L = Left Hand  
 R = Right Hand

**Table 3: Heavy Load Variable Speed 90° Sanitary VFD Gearmotors**

| Gearmotors      |     |       |      | Belt Speed |           | Drive Pulley | Driven Pulley |
|-----------------|-----|-------|------|------------|-----------|--------------|---------------|
| Part Number     | RPM | In-lb | N-m  | ft/min     | M/min     |              |               |
| 62M050(r)Z423EN | 35  | 380   | 42.9 | 1 – 6      | 0.3 – 1.8 | 19           | 32            |
| 62M050(r)Z423EN | 35  | 380   | 42.9 | 1.6 – 10   | 0.5 – 3.0 | 32           | 32            |
| 62M050(r)Z423EN | 35  | 380   | 42.9 | 3.36 – 22  | 1.1 – 6.6 | 48           | 22            |
| 62M015(r)Z423EN | 115 | 146   | 16.5 | 5.5 – 33   | 1.7 – 10  | 32           | 32            |
| 62M015(r)Z423EN | 115 | 146   | 16.5 | 8.2 – 49   | 2.5 – 15  | 48           | 32            |
| 62M015(r)Z423EN | 115 | 146   | 16.5 | 12 – 72    | 3.6 – 22  | 48           | 22            |
| 62M005(r)Z423EN | 345 | 55    | 6.2  | 9.9 – 99   | 3 – 30    | 32           | 32            |
| 62M005(r)Z423EN | 345 | 55    | 6.2  | 14 – 148   | 4.5 – 45  | 48           | 32            |
| 62M005(r)Z423EN | 345 | 55    | 6.2  | 19 – 197   | 6 – 60    | 44           | 22            |
| 62M005(r)Z423EN | 345 | 55    | 6.2  | 24 – 249   | 7.6 – 76  | 48           | 19            |

(r) = Output Shaft Orientation  
 L = Left Hand  
 R = Right Hand

**Table 4: Heavy Load Variable Speed 90° Sanitary DC Gearmotors**

| Gearmotors     |     |       |      | Belt Speed |           | Drive Pulley | Driven Pulley |
|----------------|-----|-------|------|------------|-----------|--------------|---------------|
| Part Number    | RPM | In-lb | N-m  | ft/min     | M/min     |              |               |
| 62M050(r)ZD9EN | 35  | 380   | 42.9 | 1 – 6      | 0.3 – 1.8 | 19           | 32            |
| 62M050(r)ZD9EN | 35  | 380   | 42.9 | 1.6 – 10   | 0.5 – 3.0 | 32           | 32            |
| 62M050(r)ZD9EN | 35  | 380   | 42.9 | 3.36 – 22  | 1.1 – 6.6 | 48           | 22            |
| 62M015(r)ZD9EN | 115 | 146   | 16.5 | 5.5 – 33   | 1.7 – 10  | 32           | 32            |
| 62M015(r)ZD9EN | 115 | 146   | 16.5 | 8.2 – 49   | 2.5 – 15  | 48           | 32            |
| 62M015(r)ZD9EN | 115 | 146   | 16.5 | 12 – 72    | 3.6 – 22  | 48           | 22            |
| 62M005(r)ZD9EN | 345 | 55    | 6.2  | 9.9 – 99   | 3 – 30    | 32           | 32            |
| 62M005(r)ZD9EN | 345 | 55    | 6.2  | 14 – 148   | 4.5 – 45  | 48           | 32            |
| 62M005(r)ZD9EN | 345 | 55    | 6.2  | 19 – 197   | 6 – 60    | 44           | 22            |
| 62M005(r)ZD9EN | 345 | 55    | 6.2  | 24 – 249   | 7.6 – 76  | 48           | 19            |

(r) = Output Shaft Orientation

L = Left Hand

R = Right Hand



**NOTE: For belt speed other than those listed, contact factory for details.**

# Installation

## Required Tools

- Wrenches (for hexagon head fasteners)  
8mm, 10mm, 13mm & 14mm
- 2.5 mm hex key wrench
- Straight edge
- Torque wrench

## Mounting

|   |   |                  |
|---|---|------------------|
|  |    | <h3>WARNING</h3> |
|   | <p>Exposed moving parts can cause severe injury.<br/> <b>LOCK OUT POWER</b> before removing guards or performing maintenance.</p> |                  |

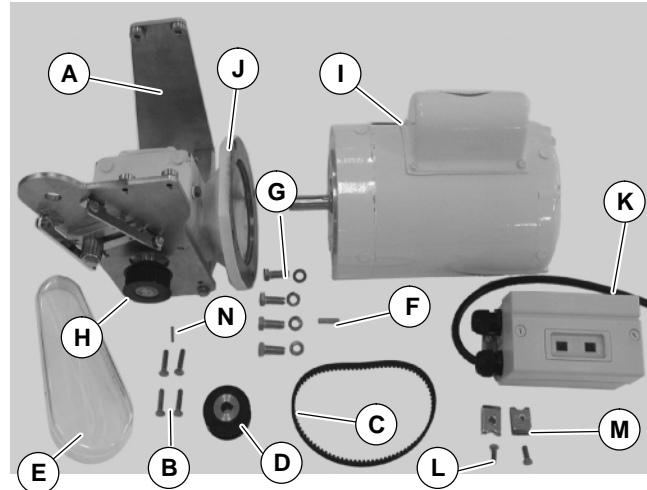

Figure 2

2. Remove screws (O of Figure 3) from both sides of conveyor.

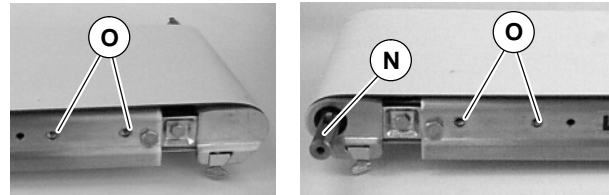

Figure 3

|  |   |                  |
|--|---|------------------|
|  |  | <h3>WARNING</h3> |
|  | <p>Drive shaft keyway may be sharp.<br/> <b>HANDLE WITH CARE.</b></p>                 |                  |

3. Install square key (N of Figure 3) into drive shaft.
- 4a. For 4" (102mm) and wider conveyors, loosen (but do not remove) screws (P of Figure 4). Attach top mount assembly (A) to conveyor with screws (B). Tighten screws (B) and (P) to 92 in-lb (10.4 Nm).

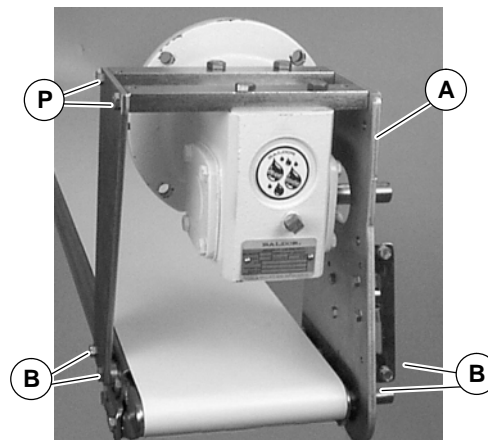

Figure 4

| Installation Component List |                                      |
|-----------------------------|--------------------------------------|
| A                           | Top Mounting Package Assembly        |
| B                           | M6 x 30 mm, Hexagon Head Screws (4x) |
| C                           | Timing Belt                          |
| D                           | Driven Pulley                        |
| E                           | Drive Cover                          |
| F                           | Motor Key                            |
| G                           | Motor Mounting Screws & Washers (4x) |
| H                           | Drive Pulley                         |
| I                           | Motor                                |
| J                           | Gear Reducer                         |
| K                           | Motor Starter                        |
| L                           | M6 x 20mm Hex Head Screws (2x)       |
| M                           | Accessory Mounting Clips             |
| N                           | Key                                  |

1. Gather components (Figure 2)

**NOTE: 4" (102mm) and wider mounting assembly shown. 2" (51mm) and 3" (76mm) wide mounting assemblies include two spacer tubes (AC of Figure 5) and two long M6 screws (AD).**

- 4b. For 2" (51mm) and 3" (76mm) wide conveyors, loosen (but do not remove) screws (P of Figure 5). Attach top mount assembly (A) to conveyor with screws (B), spacer tubes (AC) and screws (AD). Tighten screws (B) and (P) to 92 in-lb (10.4 Nm).

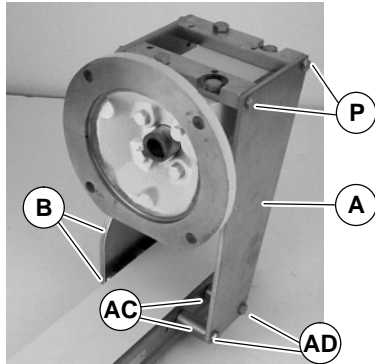

Figure 5

5. Wrap timing belt (C of Figure 6) around driven pulley (D) and drive pulley (H). Attach driven pulley (D) to conveyor shaft.

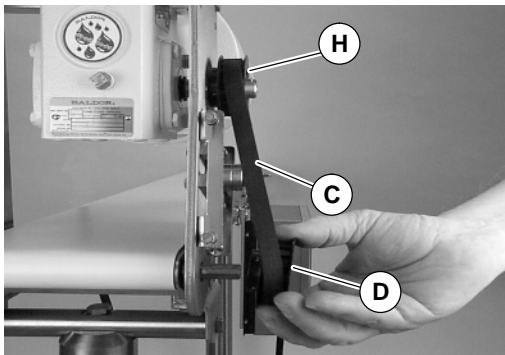

Figure 6

6. Using a straight edge (Q of Figure 7), align driven pulley (D) with drive pulley (H). Tighten driven pulley set screws (R).

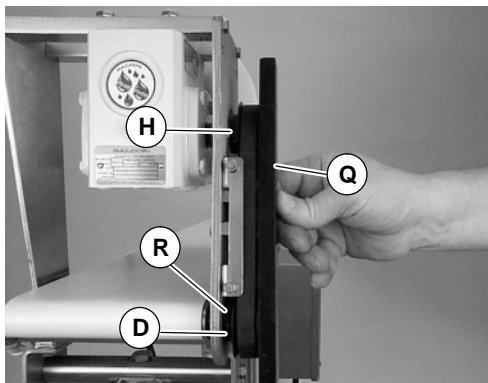

Figure 7

7. Depending on conveyor belt travel (1 or 2 of Figure 8), locate timing belt tensioner (S), as shown. Tension timing belt to obtain 1/8" (3 mm) deflection

for 1 lb (4.3 N) of force at timing belt mid-point (T). Tighten tensioner to 38 ft-lb (51 Nm).

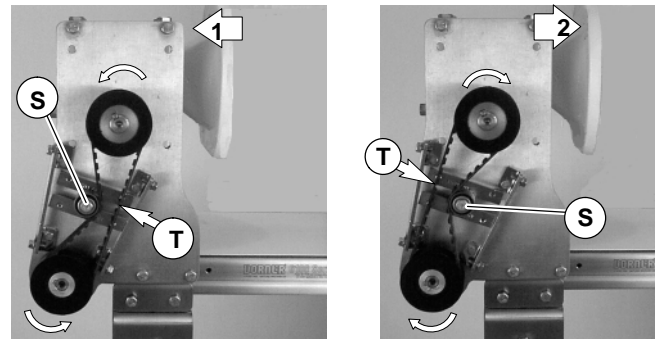

Figure 8

8. Attach cover (E of Figure 9) with screws (U). Tighten screws to 35 in-lb (4 Nm).

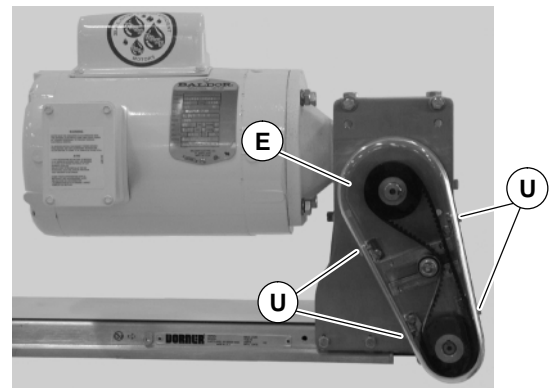

Figure 9



9. Install key (F of Figure 10).



Figure 10

**IMPORTANT:** Be extremely careful when coupling motor to gear reducer. Avoid misalignment and forcing the connection causing possible permanent gear reducer seal damage.

# Installation

10. Attach gear motor (I of Figure 11) to gear reducer (J) with screws and washers (G of Figure 10). Tighten to 32 ft-lb (41 Nm).

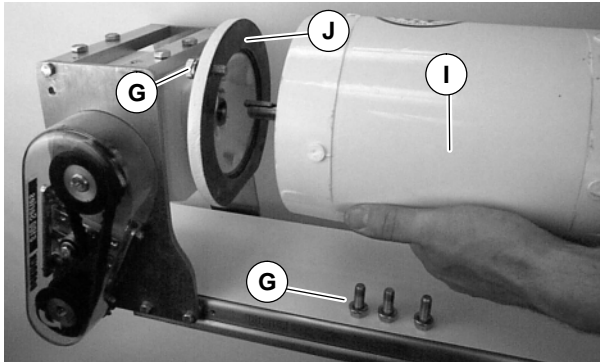

Figure 11

11. Attach mounting clips (M of Figure 12) to conveyor.

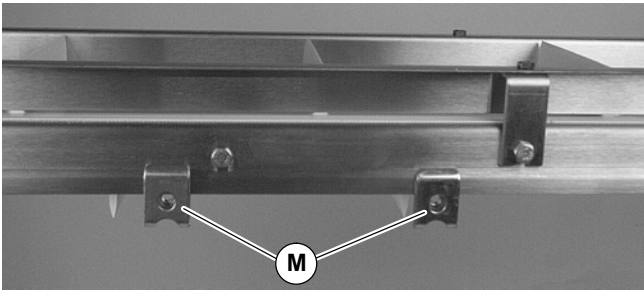

Figure 12

**NOTE:** Three-phase Motor Starter shown, Single-phase Starter similar. For VFD controller mounting, see accessory instructions.

12. Attach motor starter (K of Figure 13) to clips with screws (L). Tighten to 92 in-lb (10.4 Nm).

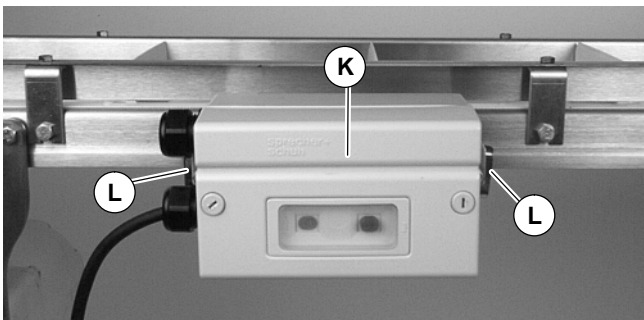

Figure 13

## Wiring

### Single-phase Motor Starter

**NOTE:** Power cord must be plugged into a GFI outlet. No additional wiring is required.

### Three-phase Motor Starter

|  |   |
|--|---|
|  | <p><b>! DANGER</b></p> <p>Hazardous voltage will cause severe injury or death.</p> <p><b>LOCKOUT POWER BEFORE WIRING.</b></p> |
|--|---|

**NOTE:** 230 volt three-phase manual motor starters must be wired in accordance with applicable electrical codes.

1. Loosen cover screws (V of Figure 14) and remove cover.

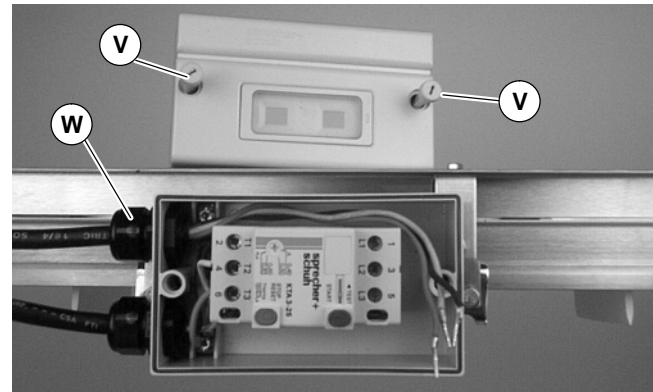

Figure 14

**NOTE:** Line cord must be 0.28" (7 mm) minimum to 0.47" (12 mm) maximum in diameter.

2. Insert line cord through grip (W) and tighten nut.
3. For correct three-phase motor shaft rotation, connect line phase sequence L1, L2 & L3 to terminals as shown (Figure 15).



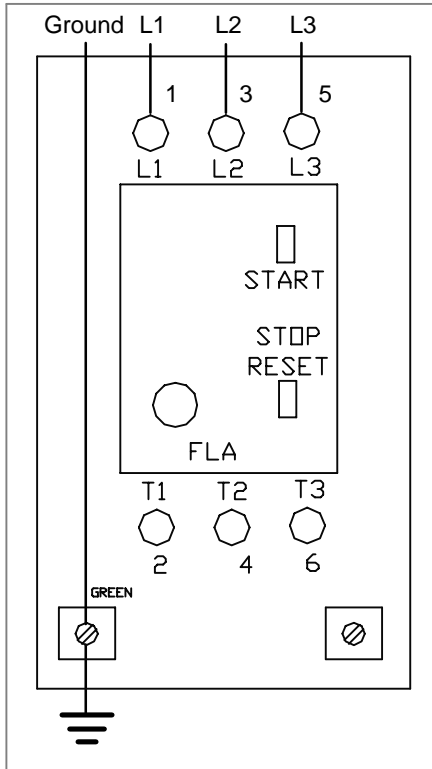

Figure 15

## WARNING

Controller must be properly grounded. Failure to properly ground control box may cause injury to personnel.

**NOTE:** The motor ground wire is also attached to left terminal marked  $\perp$  (Figure 15).

4. Attach ground wire to lower left terminal marked  $\perp$  (see Figure 15).
5. Replace starter cover and tighten screws (V of Figure 14).

## VFD Controllers

**NOTE:** Refer to VFD Controller Set-up, Operation & Maintenance Manual.

# Preventive Maintenance & Adjustment

## Required Tools

- Wrenches (for hexagon head fasteners)  
8mm, 10mm, 13mm, 14mm
- 2.5 mm hex key wrench
- Straight edge
- Torque wrench

## Timing Belt Replacement



## WARNING

Exposed moving parts can cause severe injury.  
**LOCK OUT POWER** before removing guards or performing maintenance.

1. Loosen four (4) screws (U of Figure 16) and remove cover (E).

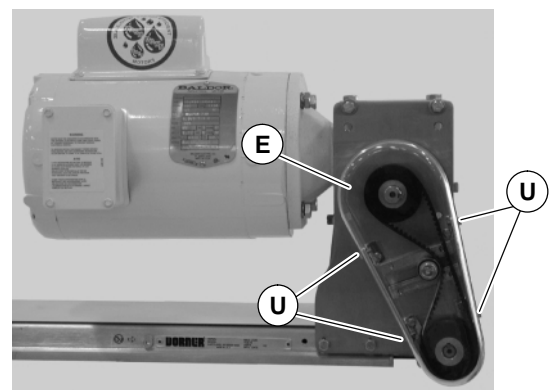

Figure 16

# Preventive Maintenance & Adjustment

- Loosen tensioner (S of Figure 17).

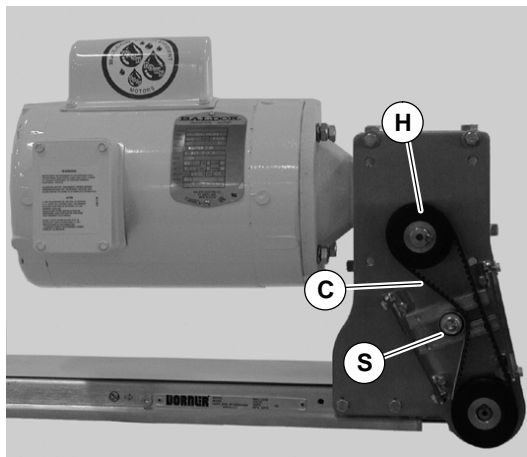

Figure 17

- Remove timing belt (C).

**NOTE:** If timing belt does not slide over pulley flange, loosen driven pulley set screws (R of Figure 18) and remove pulley with belt. For re-installation, see steps 5 and 6 on page 7.

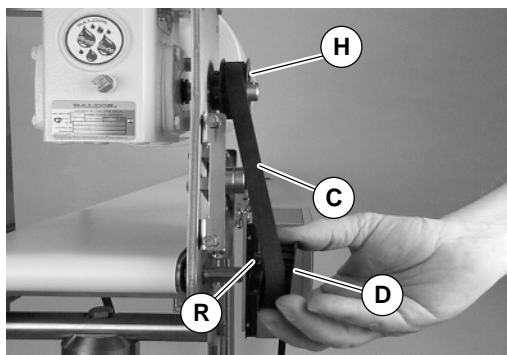

Figure 18

- Install new timing belt.
- Depending on conveyor belt travel (1 or 2 of Figure 19), locate timing belt tensioner (S) as shown. Tension timing belt to obtain 1/8" (3 mm) deflection for 1 lb (4.3 N) of force at timing belt mid-point (T). Tighten tensioner to 38 ft-lb (51 Nm).

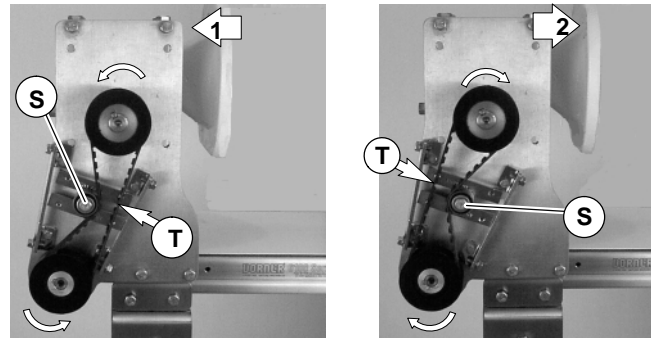

Figure 19

**NOTE:** Do not over-tighten screws (U of Figure 20).

- Attach cover (E of Figure 20) and tighten four (4) screws (U) to 35 in-lb (4 Nm).

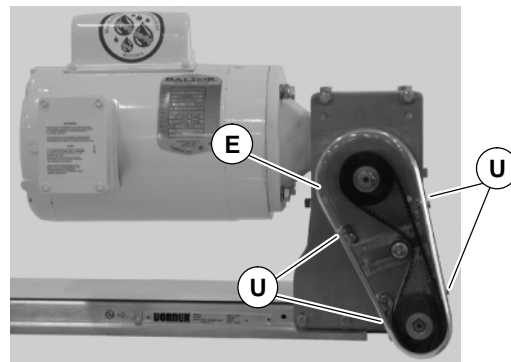

Figure 20

## Timing Belt Tensioning

|  |   |                  |
|--|---|------------------|
|  |   | <h3>WARNING</h3> |
|  | <p>Exposed moving parts can cause severe injury.<br/> <b>LOCK OUT POWER</b> before removing guards or performing maintenance.</p> |                  |

- Remove four (4) screws (U of Figure 21) and remove cover (E).

# Preventive Maintenance and Adjustment

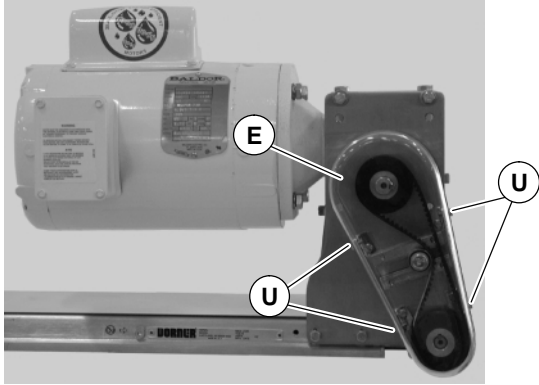

Figure 21

2. Loosen tensioner (S of Figure 22).

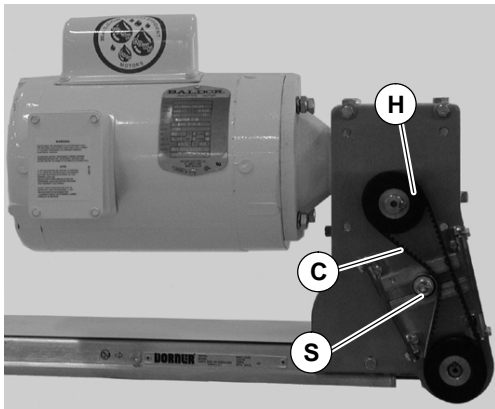

Figure 22

3. Depending on direction of conveyor belt travel (1 or 2 of Figure 23), position belt tensioner (S) as shown. Tension belt to obtain 1/8" (3 mm) deflection for 1.0 lb (456 grams) of force at belt mid-point (T). Tighten tensioner screw to 103 in-lb (12 Nm).

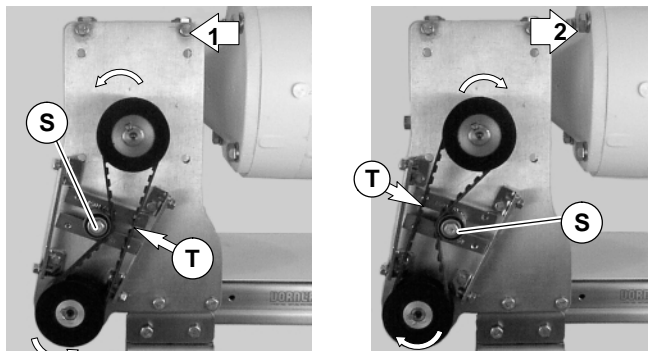

Figure 23

4. Attach cover (E of Figure 21) with four (4) screws (U). Tighten to 35 in-lb (4 Nm).

## Drive or Driven Pulley Replacement

|  |   |
|--|---|
|  | <b>WARNING</b>  |
|  | <p>Exposed moving parts can cause severe injury.</p> <p><b>LOCK OUT POWER</b> before removing guards or performing maintenance.</p> |

1. Complete steps 1 through 3 of "Timing Belt Replacement" section on page 10.
2. Loosen set screws and remove drive or driven pulley.

**NOTE:** If drive pulley (H of Figure 22) is replaced, wrap timing belt around drive pulley and complete step 3.

3. Complete steps 5 through 8 of "Installation" section on page 7.

## Gear Reducer Replacement

|  |   |
|--|---|
|  | <b>WARNING</b>  |
|  | <p>Exposed moving parts can cause severe injury.</p> <p><b>LOCK OUT POWER</b> before removing guards or performing maintenance.</p> |

1. Remove four (4) screws (U of Figure 24) and remove cover (E).

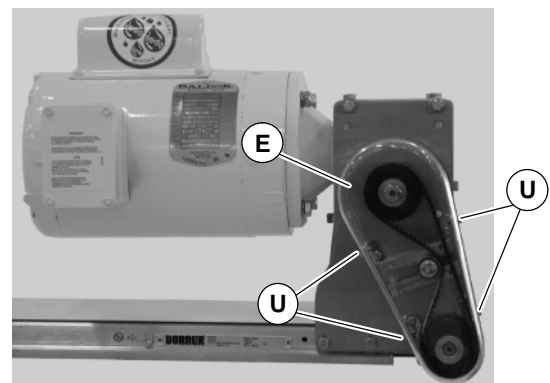

Figure 24

# Preventive Maintenance and Adjustment

2. Loosen tensioner (S of Figure 25).

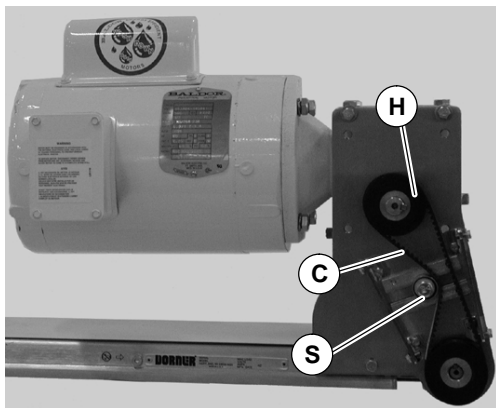

Figure 25

3. Loosen drive pulley set screws (X of Figure 26). Remove drive pulley (H) and timing belt (C).

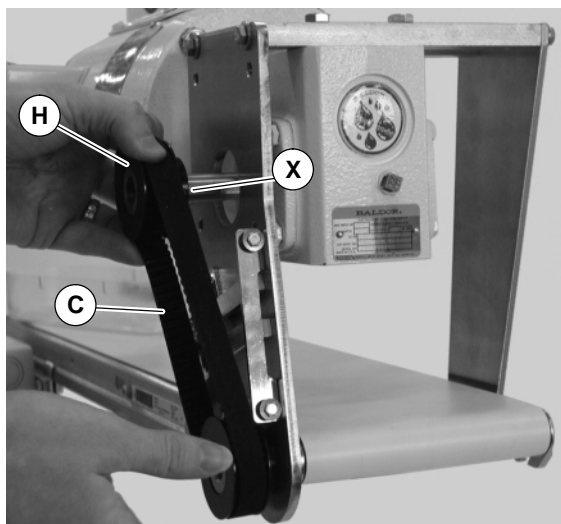

Figure 26

4. Remove screws and washers (G of Figure 27). Detach motor (I) from gear reducer (J).

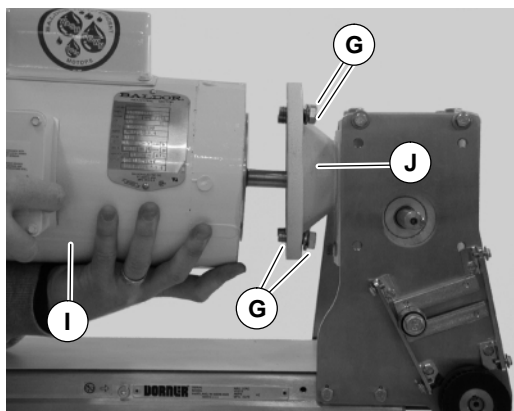

Figure 27

5. Remove four (4) gear reducer mounting screws (Z of Figure 28). Remove gear reducer (J).

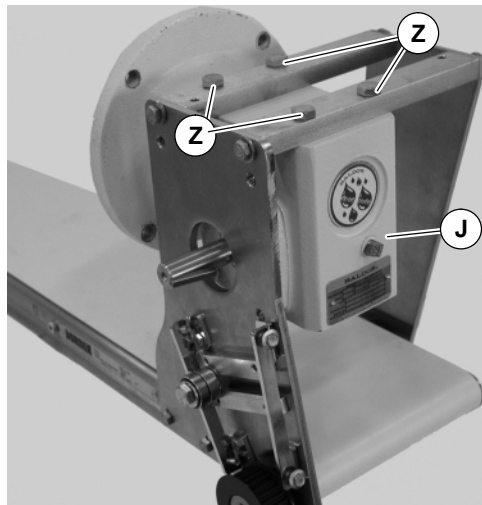

Figure 28

6. Attach new gear reducer to top mount with screws (Z).

---

**IMPORTANT:** Be extremely careful when coupling motor to gear reducer. Avoid misalignment and forcing the connection causing possible permanent gear reducer seal damage.

---

7. With key (F of Figure 29) in keyway, slide motor (I) and gear reducer (J) together. Install screws (G) and tighten.

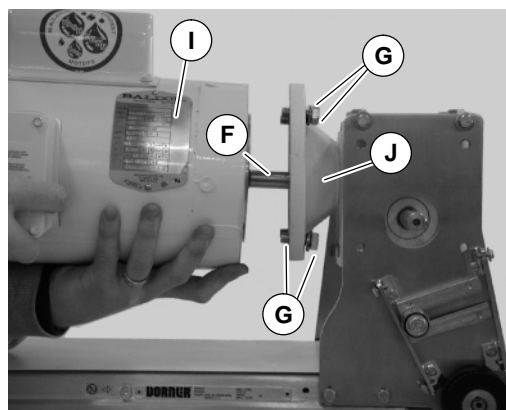

Figure 29

# Preventive Maintenance and Adjustment

8. Wrap timing belt (C of Figure 30) around drive pulley (H) and driven pulley (D). Attach drive pulley (H) to gear reducer shaft.

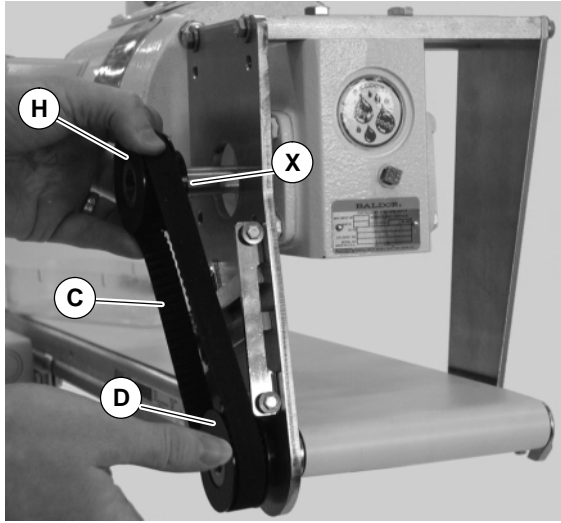

Figure 30

9. Using a straight edge (Q of Figure 7), align drive pulley (H) with driven pulley (D). Tighten drive pulley set screws (X).

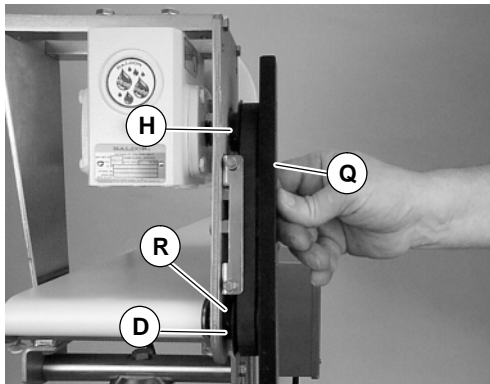

Figure 31

10. Depending on conveyor belt travel (1 or 2 of Figure 32), locate timing belt tensioner (S), as shown. Tension timing belt to obtain 1/8" (3 mm) deflection for 1 lb (4.3 N) of force at timing belt mid-point (T). Tighten tensioner to 38 ft-lb (51 Nm).

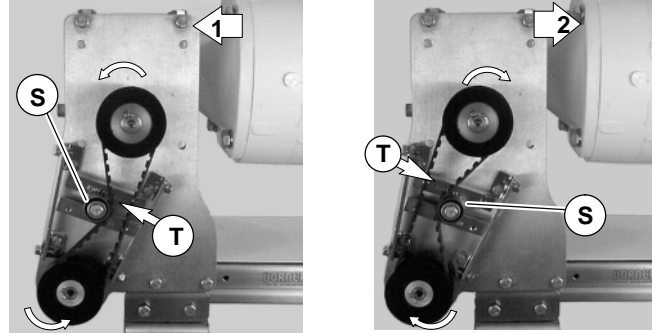

Figure 32

11. Attach cover (E of Figure 33) with screws (U). Tighten screws to 35 in-lb (4 Nm).

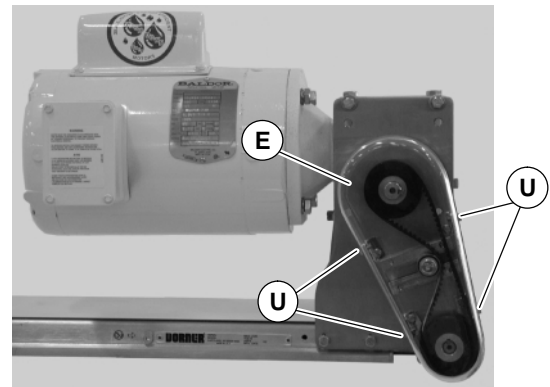
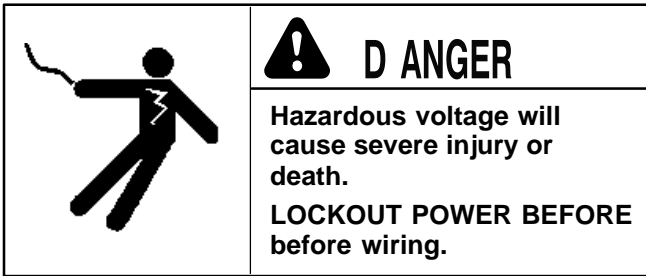
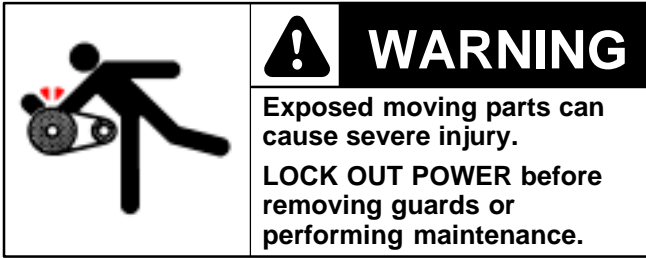

Figure 33

# Preventive Maintenance and Adjustment

## Motor Replacement



1. Loosen terminal box screws (AA of Figure 34) and remove cover (AB).

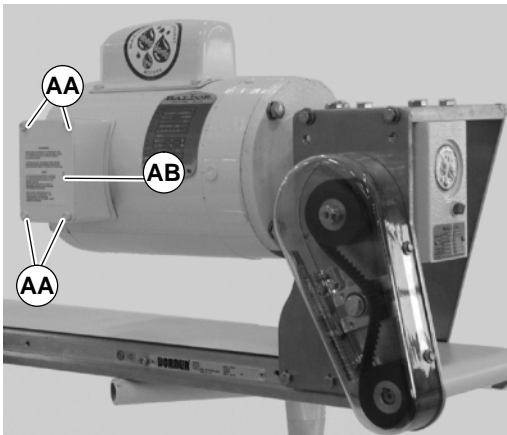

Figure 34

2. Record incoming wire colors. Loosen wire nuts and remove wires.
3. Loosen cord grip and remove cord.

4. Remove screws and washers (G of Figure 35). Detach motor (I) from gear reducer (J). Retain motor output shaft key (F).

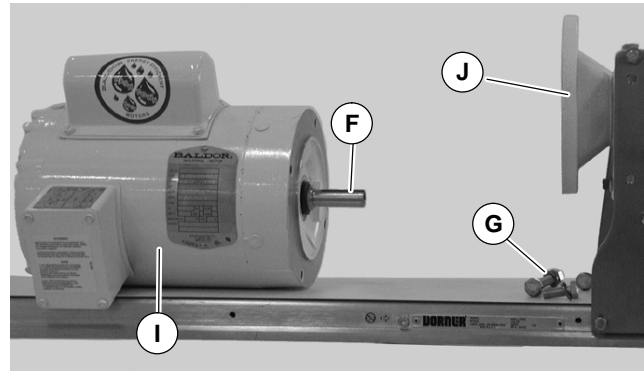

Figure 35

**IMPORTANT:** Be extremely careful when coupling motor to gear reducer. Avoid misalignment and forcing the connection causing possible permanent gear reducer seal damage.

5. With key (F of Figure 36) in keyway, slide new gear motor and gear reducer (J) together. Install screws and washers (G) and tighten.

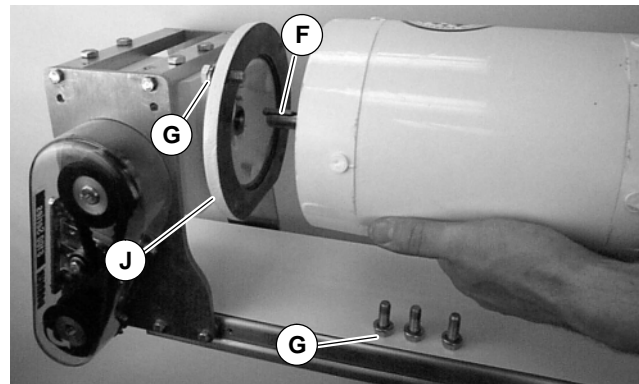

Figure 36

6. To replace wiring, reverse steps 1, 2 and 3 on this page.



**NOTE:** For replacement parts other than those shown on this page, contact an authorized Dorner Service Center or the factory.

| Item | Part Number | Part Description   |
|------|-------------|--|
| 1    | 826-311     | Motor, 0.5 hp (0.37 Kw) 115/208-230 Volts, 60 Hz, 1-Phase                |
|      | 826-312     | Motor, 0.5 hp (0.37 Kw), Inverter Duty 208-230/460 Volts, 60 Hz, 3-Phase |
|      | 826-313     | Motor, 0.25 hp (0.19 Kw) 130 Volts DC                                    |
| 2    | 62M050LZ    | Gear Reducer, 50:1, 56C LH   |
|      | 62M050RZ    | Gear Reducer, 50:1, 56C RH   |
|      | 62M015LZ    | Gear Reducer, 15:1, 56C LH   |
|      | 62M015RZ    | Gear Reducer, 15:1, 56C RH   |
|      | 62M005LZ    | Gear Reducer, 5:1, 56C LH  |
|      | 62M005RZ    | Gear Reducer, 5:1, 56C RH  |
| 3    | 814-104     | Timing Belt, 15mm W x 450mm L  |
|      | 814-105     | Timing Belt, 15mm W x 460mm L  |
|      | 814-065     | Timing Belt, 15mm W x 475mm L  |
|      | 814-101     | Timing Belt, 15mm W x 500mm L  |
|      | 814-108     | Timing Belt, 15mm W x 520mm L  |
|      | 814-064     | Timing Belt, 15mm W x 535mm L  |
|      | 814-099     | Timing Belt, 15mm W x 565mm L  |
| 4    | 802-123     | Tensioner Bearing (2x Required)  |
| 5    | 450365MP    | Driven Pulley, 19 Tooth, 12mm bore                                       |
|      | 450366MP    | Driven Pulley, 22 Tooth, 12mm bore                                       |
|      | 450367MP    | Driven Pulley, 28 Tooth, 12mm bore                                       |
|      | 450368MP    | Driven Pulley, 32 Tooth, 12mm bore                                       |
| 6    | 980422M     | Square Key, 4 mm x 22 mm   |
| 7    | 450397      | Drive Pulley, 19 Tooth, .62" bore  |
|      | 450398      | Drive Pulley, 22 Tooth, .62" bore  |
|      | 450399      | Drive Pulley, 28 Tooth, .62" bore  |
|      | 450400      | Drive Pulley, 32 Tooth, .62" bore  |
|      | 450430      | Drive Pulley, 44 Tooth, .62" bore  |
|      | 450431      | Drive Pulley, 48 Tooth, .62" bore  |
|      | 450432      | Drive Pulley, 60 Tooth, .62" bore  |
| 8    | 683526      | Key, Square, 0.188" x .62" L, Stainless Steel                            |

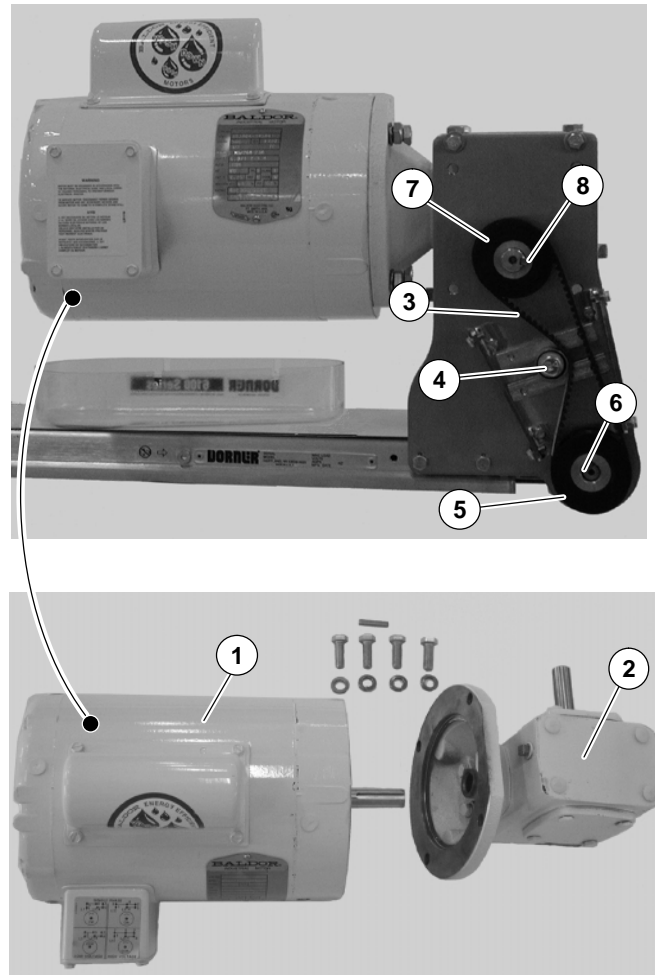

**Figure 37**

---

## Return Policy

---

No returns will be accepted without prior written factory authorization. When calling for authorization, please have the following information ready for the Dorner Factory representative or your local distributor:

1. Name and address of customer.
2. Item(s) being returned.
3. Reason for return.
4. Customer's original order number used when ordering the item(s).
5. Dorner or distributor invoice number.

A representative will discuss action to be taken on the Returned items and provide a Returned Goods Authorization Number to reference.

There will be a 15% restocking charge on all new items returned for credit where Dorner was not at fault. These will not be accepted after 60 days from original invoice date. The restocking charge covers inspection, cleaning, disassembly, and reissuing to inventory.

If a replacement is needed prior to evaluation of returned item, a purchase order must be issued. Credit (if any) is issued only after return and evaluation is complete.

Dorner has representatives throughout the world. Feel free to contact Dorner for the name of your local representative. Our technical sales and service staff will gladly help with your questions on Dorner products.

For a copy of Dorner's Limited Warranty, contact factory, distributor, service center or visit our website @ [www.dorner.com](http://www.dorner.com)

For replacement parts, contact an authorized  
Dorner Service Center or the factory.

**DORNER**<sup>®</sup>

Dorner Mfg. Corp. reserves the right to change or discontinue products without notice. All products and services are covered in accordance with our standard warranty. All rights reserved. ©Dorner Mfg. Corp. 2000

**DORNER MFG. CORP.**

580 Industrial Drive, PO Box 20  
Hartland, WI 53029-0020 USA

**USA**  
TEL 1-800-397-8664 (USA)  
FAX 1-800-369-2440 (USA)

**Outside the USA:**  
TEL 1-262-367-7600, FAX 1-262-367-5827

**DORNER**

Arnold-Sommerfeld-Ring 2  
D-52499 Baesweiler  
Germany

TEL (02401) 80 52 90  
FAX (02401) 80 52 93

Internet: [www.dorner.com](http://www.dorner.com)