

2100, 4100, 6100 Series Side Mount Drive Package for Standard Load 50 Hz Gearmotors

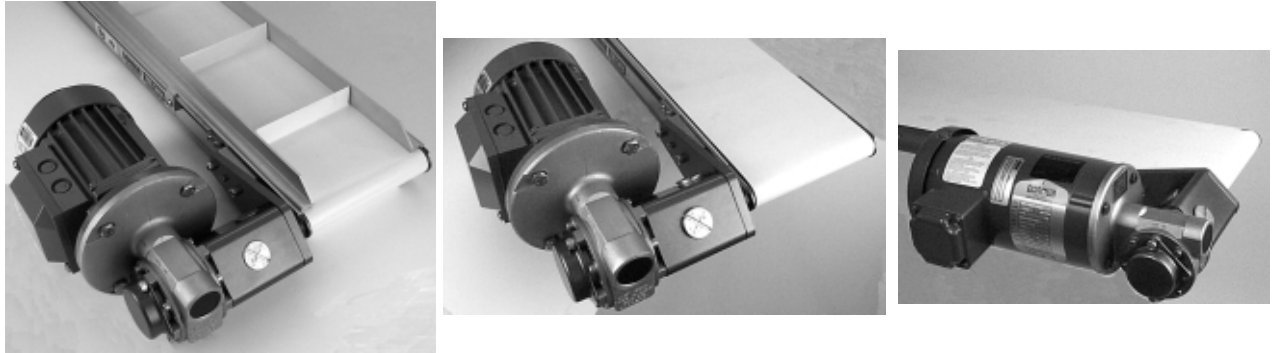



Table of Contents

Warnings – General Safety	2	Preventative Maintenance & Adjustment	7
Introduction	2	Required Tools	7
Product Description	3	Gear Reducer Replacement	7
Specifications	3	Motor Replacement	8
Installation	5	Service Parts	10
Required Tools	5	Return Policy	10
Mounting	5		
For 2100 & 4100 Flat Belt Conveyors	5		
For 6100 Conveyors & 2100 Cleated Belt Conveyors	6		

Warnings – General Safety



	WARNING	
<p>The safety alert symbol, black triangle with white exclamation, is used to alert you to potential personal injury hazards.</p>		



		WARNING
<p>Gearmotors may be HOT. DO NOT TOUCH Gearmotors.</p>		

		DANGER
<p>Climbing, sitting, walking or riding on conveyor will cause severe injury. KEEP OFF CONVEYORS.</p>		

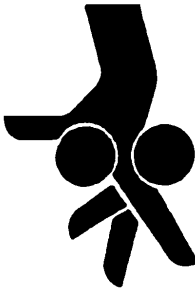
		WARNING
<p>Exposed moving parts can cause severe injury. REPLACE ALL GUARDS BEFORE RUNNING CONVEYOR.</p>		

		DANGER
<p>Do NOT OPERATE CONVEYORS IN AN EXPLOSIVE ENVIRONMENT.</p>		

		WARNING
<p>Dorner cannot control the physical installation and application of conveyors. Taking protective measures is the responsibility of the user. When conveyors are used in conjunction with other equipment or as part of a multiple conveyor system, CHECK FOR POTENTIAL PINCH POINTS and other mechanical hazards before system start-up.</p>		

		WARNING
<p>Exposed moving parts can cause severe injury. LOCK OUT POWER before removing guards or performing maintenance.</p>		

Introduction

IMPORTANT: Some illustrations may show guards removed. Do NOT operate equipment without guards.

Upon receipt of shipment:

- Compare shipment with packing slip. Contact factory regarding discrepancies.
- Inspect packages for shipping damage. Contact carrier regarding damage.
- Accessories may be shipped loose. See accessory instructions for installation.

Dorner 2100 Series conveyors are covered by the following patent numbers: 5131529, 5174435, and corresponding patents and patent applications in other countries.

Dorner 4100 Series conveyors are covered by patent number 3923148 and corresponding patents and patent applications in other countries.

Dorner 6100 Series conveyors are covered by patent number 5174435 and corresponding patents and patent applications in other countries.

Dorner's Limited Warranty applies.

Dorner reserves the right to make changes at any time without notice or obligation.

Product Description

Refer to Figure 1 for typical components.

Typical Components	
A	Conveyor
B	Mounting Bracket
C	Gearmotor
D	Coupling
E	Inspection Plug

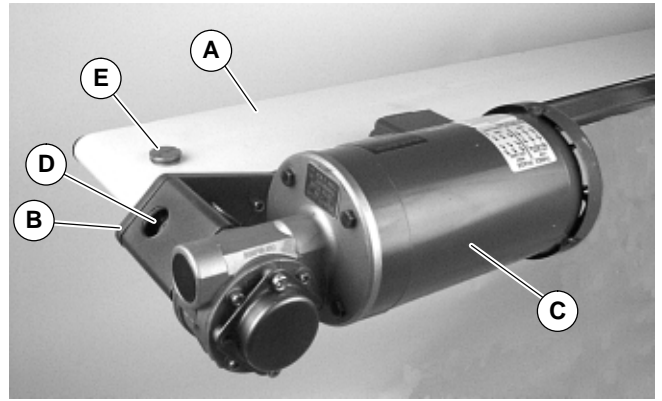
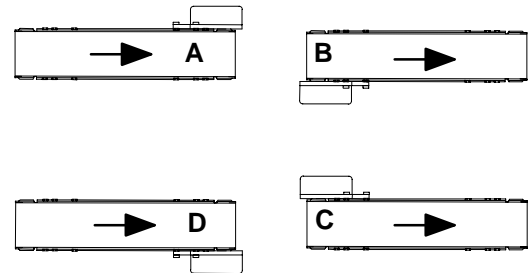
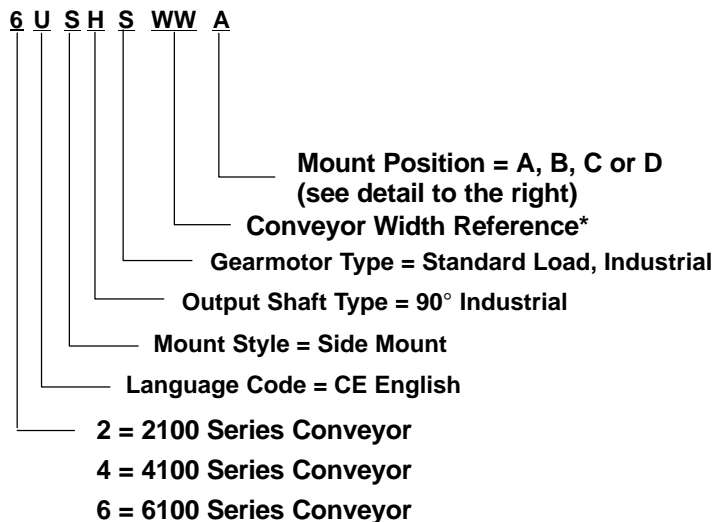

Figure 1

Specifications

Gearmotor Mounting Package Models:

Example:



* See "Ordering and Specifications" Catalog for details.

Table 1: Gearmotor Specifications

	Single Phase	Three Phase	VFD Variable Speed
Output Power	0.18 kw		
Input Voltage	230 Volts A.C.	230/400 Volts A.C.	230 Volts A.C.
Input Frequency	50 Hz		25 to 63 Hz
Input Current	1.6 Amperes	1.4/0.8 Amperes	1.4 Amperes
Gearmotor Ratios	5:1, 10:1, 20:1, 40:1, 60:1		
Protection Rating	IP55		
Frame Size	IEC 63 B5		

Specifications

Table 2: Belt Speeds for Standard Load Fixed Speed 90° 50 Hz Gearmotors

Gearmotors			Belt Speed M/min
Part Number	RPM	N-m	
62Z060HS4(vp)FN	23	26.4	2.1
62Z040HS4(vp)FN	35	28.9	3.0
62Z020HS4(vp)FN	70	19.4	6.1
62Z010HS4(vp)FN	140	10.7	12.2
62Z005HS4(vp)FN	280	5.6	24.4

(vp) = voltage and phase
21 = 230 V, 1-phase
23 = 230 V, 3-phase
43 = 400 V, 3-phase

Table 3: Belt Speeds for Standard Load Variable Speed 90° 50 Hz Gearmotors

Gearmotors			Belt Speed M/min
Part Number	RPM @ 50Hz	N-m	
62Z060HS423EN	23	26.4	1.0 to 2.6
62Z040HS423EN	35	28.9	1.5 to 3.8
62Z020HS423EN	70	19.4	3.0 to 7.7
62Z010HS423EN	140	10.7	6.1 to 15.0
62Z005HS423EN	280	5.6	12.2 to 30

NOTE: For belt speed other than those listed, contact factory for details.

Required Tools

- Hex key wrenches:
3 mm & 5 mm
- Large flat-blade screwdriver
- Torque wrench

Mounting

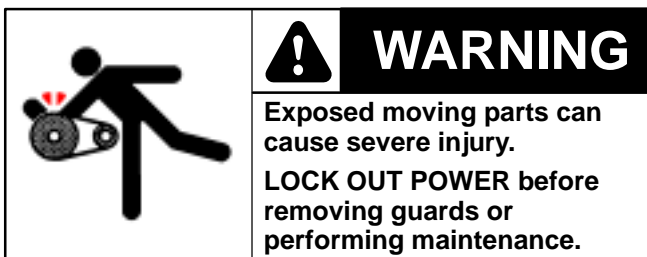

Installation Component List

F	Drive Assembly
G	M6 Socket Head Screws (2x)
H	Hex Shaft (2100 & 4100 flat belt conveyor only)
I	Socket Head Screws M6 x 90 mm (4x)
J	Screws
K	Inspection Plugs (2x)
L	Set Screws (2x)
M	Access Hole
N	Key (2100 cleated belt or 6100 conveyors only)

1. Typical components (Figure 2)

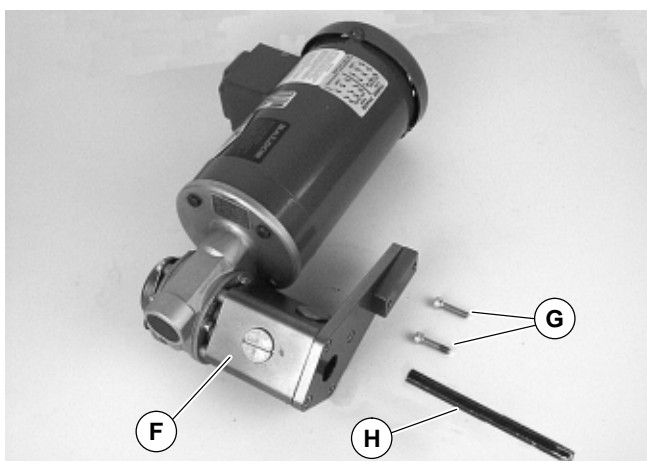

Figure 2

NOTE: Gearmotor may be operated in positions 1, 2, 3 or 4 (Figure 3).

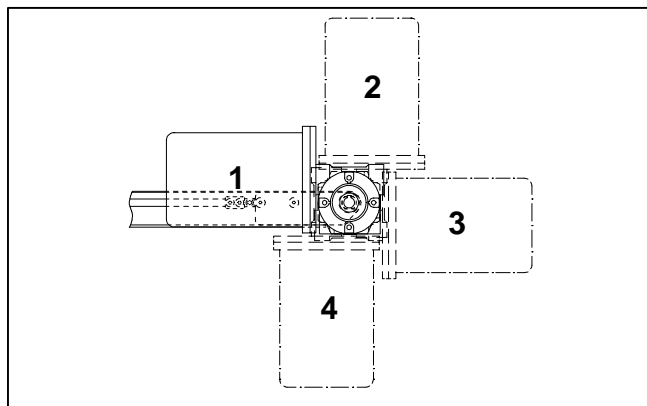

Figure 3

2. If required, change gearmotor position by removing four (4) screws (I of Figure 4). Rotate gearmotor to other position (Figure 3) and replace screws (I). Tighten to 12 Nm.

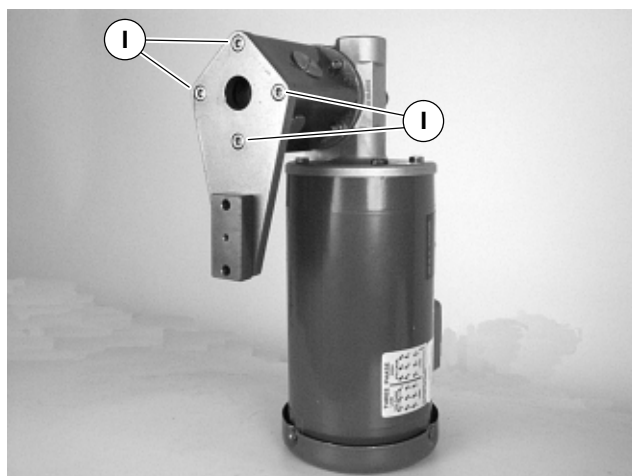

Figure 4

For 2100 & 4100 Flat Belt Conveyors

IMPORTANT: On 95 mm and wider conveyors, the hex broach is offset from center towards the drive side for hex shaft engagement.

- 3a. Locate drive mounting position and remove two (2) screws (J of Figure 5).

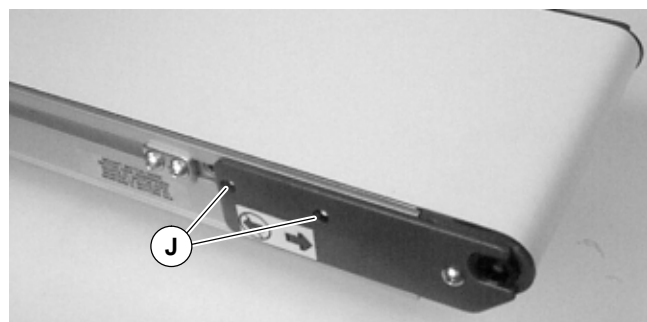

Figure 5

Installation

4a. Remove inspection plugs (K of Figure 6).

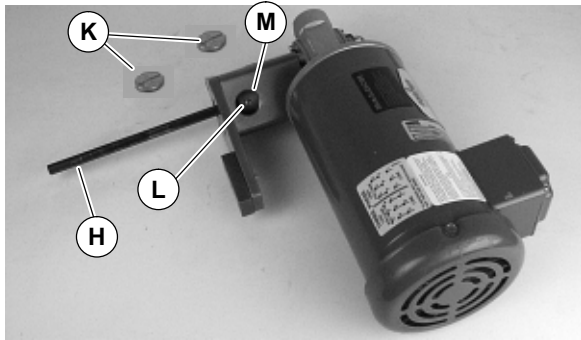
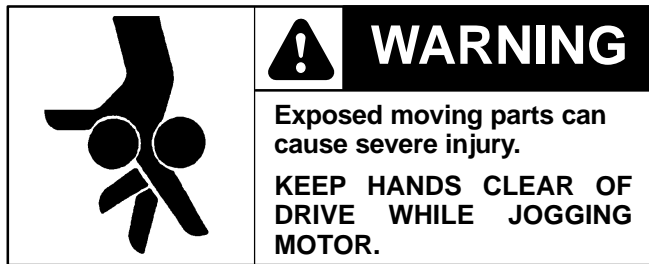

Figure 6

5a. Insert hex shaft (H) into coupling.



NOTE: Coupling has two (2) set screws (L of Figure 7).

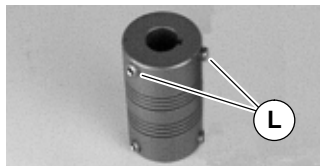
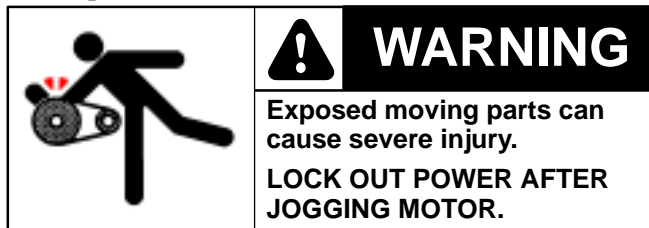

Figure 7

6a. Jog motor and rotate coupling to align set screw (L of Figure 6) with access hole (M). Tighten to 3.7 Nm. Repeat for second set screw.



7a. Replace inspection plugs (K of Figure 8). Insert hex shaft (H) into drive pulley hex bushing and slide drive against conveyor. Install two (2) screws (G). Tighten to 80 in-lb (9 Nm).

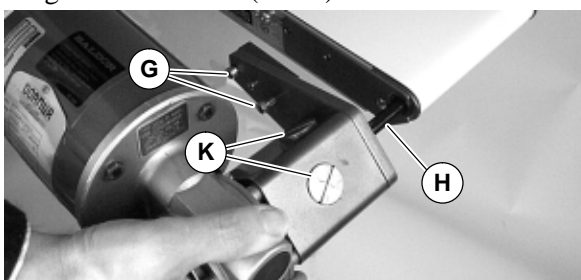
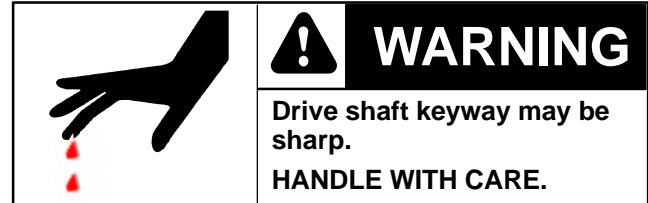

Figure 8

For 6100 Conveyors & 2100 Cleated Belt Conveyors



NOTE: 6100 conveyor shown, 2100 cleated belt conveyor similar.

3b. Locate drive output shaft. Remove two screws (J of Figure 9). Install key (N).

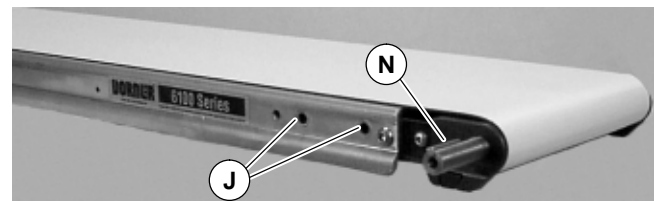

Figure 9

4b. Remove inspection plugs (K of Figure 10).

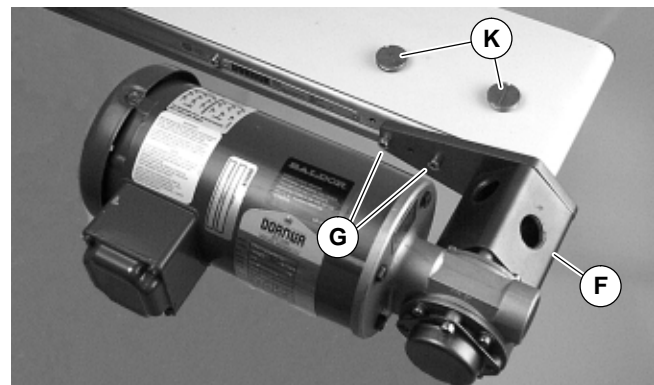
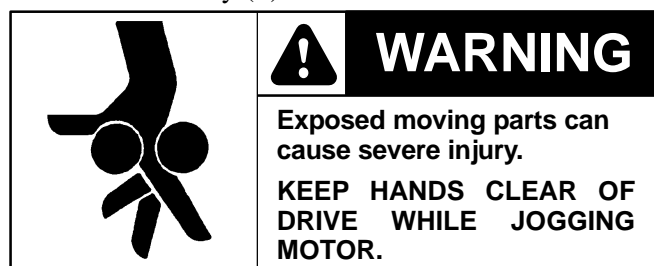

Figure 10

5b. Slide coupling over drive output shaft and install drive assembly (F).



NOTE: Coupling has two (2) set screws (L of Figure 7).

6b. Jog motor and rotate coupling to align set screw (L of Figure 11) with access hole (M). Tighten to 3.7 Nm. Repeat for second set screw.

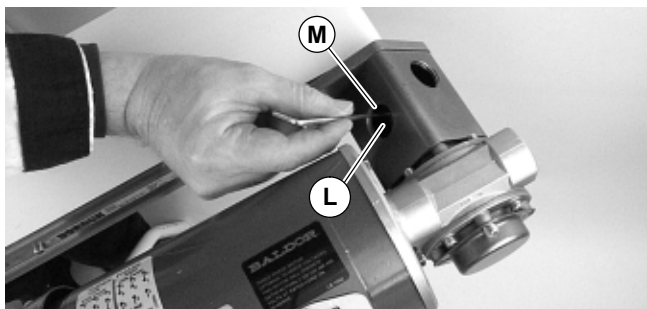
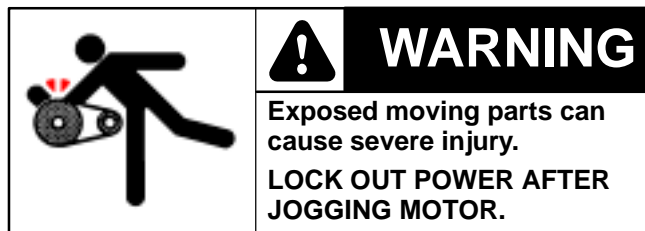

Figure 11



7b. Replace inspection plugs. (K of Figure 10)

Preventive Maintenance and Adjustment

Required Tools

- Hex key wrenches:
2.5 mm, 3 mm, 5 mm
- Large flatblade screwdriver
- Adjustable wrench (for hexagon head screws)
- Torque wrench

Gear Reducer Replacement

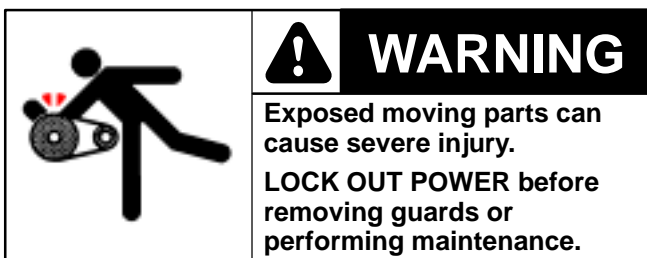

1. Remove inspection plug(s) (K of Figure 10).

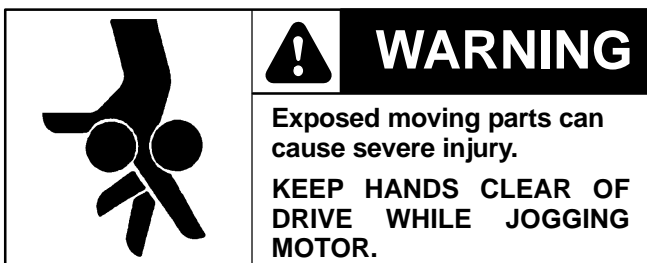

NOTE: Coupling has two (2) set screws (L of Figure 7).

2. Jog motor and rotate coupling to align set screw (L of Figure 11) with access hole (M). Loosen set screw. Repeat for second set screw.
3. Remove two (2) screws (G of Figure 10). Remove drive assembly (F).

4. Remove four (4) screws (I of Figure 12) and remove mounting bracket & guard (O).

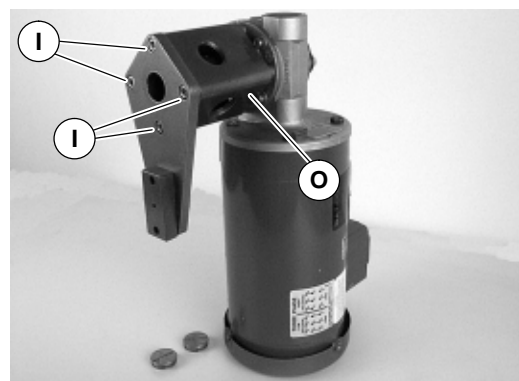

Figure 12

5. Loosen two (2) set screws (L of Figure 13) and detach coupling (P).

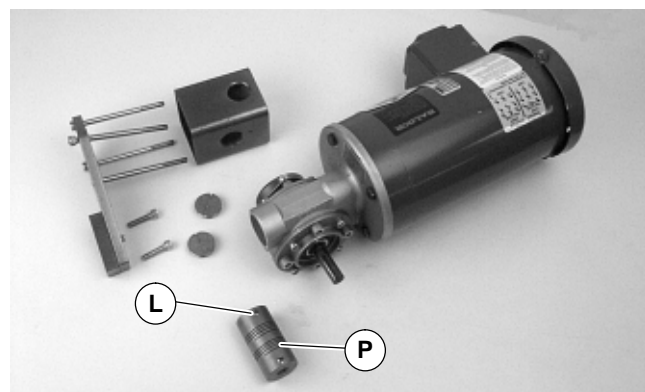

Figure 13

6. Remove four screws (Q of Figure 14). Detach motor with adapter flange (R) from gear reducer (S). Retain motor output shaft key (T).

Preventive Maintenance and Adjustment

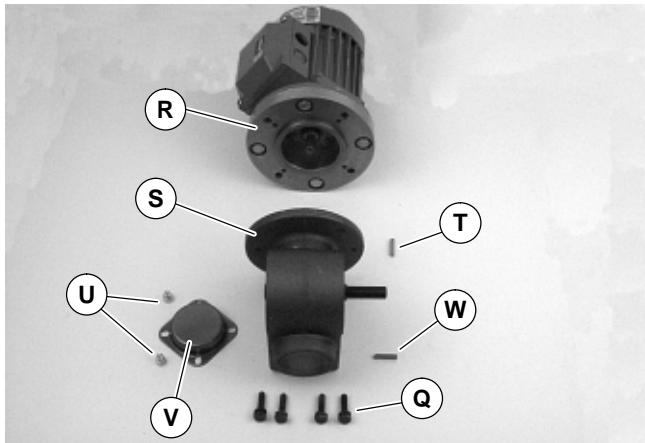

Figure 14

7. Remove two (2) screws (U) and detach output shaft cover (V).
8. Remove gear reducer output shaft key (W).
9. Loosen six (6) set screws (X of Figure 15). Remove drive shaft (Y) and key (Z).

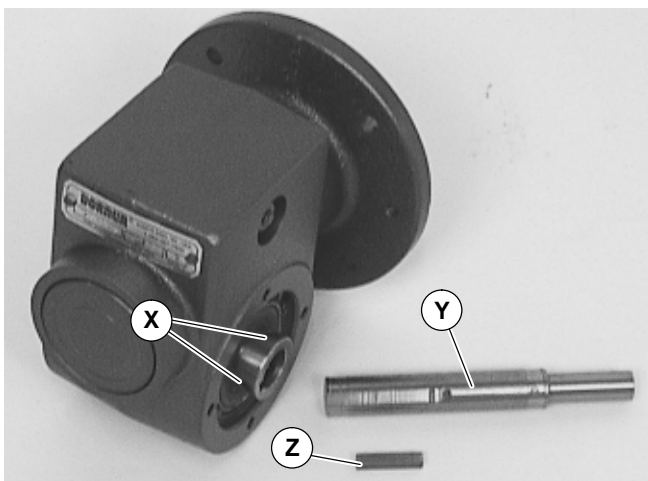

Figure 15

10. Apply grease (AA of Figure 16) to shaft.

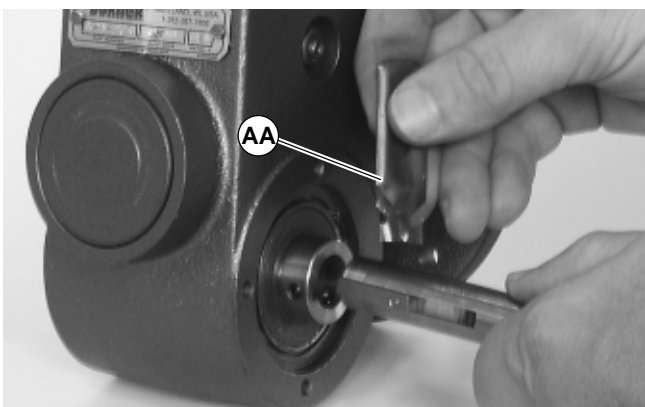

Figure 16

11. Replace the original shaft (Y Figure 15) and key (Z) into new gear reducer. Tighten set screws to 3 Nm.

IMPORTANT: Be extremely careful when coupling motor to gear reducer. Avoid misalignment and forcing the connection causing possible permanent gear reducer seal damage.

12. With key (T of Figure 14) in keyway, slide motor with adapter flange (R) and gear reducer (S) together. Install screws (Q) and tighten.
13. Attach coupling (P of Figure 13) to gear reducer shaft. Tighten two (2) set screws (L) to 3.7 Nm.
14. Attach mounting bracket & tube (O of Figure 12) to gearmotor. Tighten screws (I) to 12 Nm.
15. Complete installation steps:
 - See “2100 Flat Belt Conveyors” section on page 5.
 - See “6100 and 2100 Cleated Belt Conveyors” section on page 6.

Motor Replacement

		<h3>WARNING</h3>
	<p>Exposed moving parts can cause severe injury. LOCK OUT POWER before removing guards or performing maintenance.</p>	

		<h3>DANGER</h3>
	<p>Hazardous voltage will cause severe injury or death. LOCK OUT POWER BEFORE WIRING.</p>	

1. For single phase motor:
 - a. Loosen terminal box screws (AB of Figure 17) and remove cover (AC).



Figure 17

- b. Record wire colors on terminals 2, 6 and ground (\perp) (Figure 18). Loosen terminals 2, 6 and ground and remove wires.

Preventive Maintenance and Adjustment

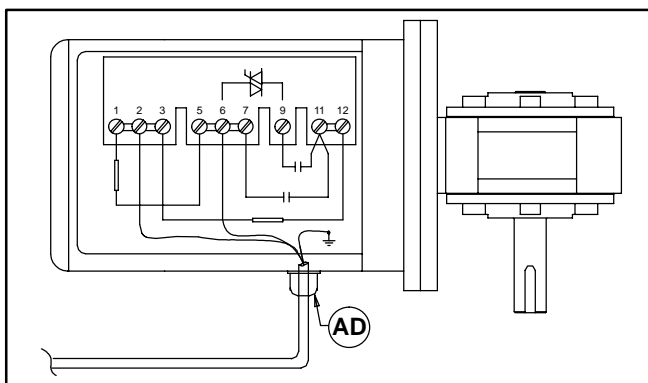

Figure 18

- c. Loosen cord grip (AD of Figure 18) and remove cord.
2. For three phase and VFD variable speed motor:
 - a. Loosen terminal box screws (AB of Figure 17) and remove cover (AC).
 - b. Record wire colors on terminals U1, V1, W1 & PE (Figure 19). Loosen terminals U1, V1, W1 & PE and remove wires.

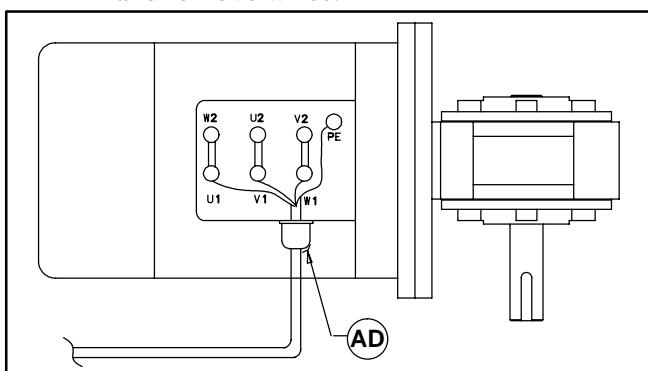

Figure 19

- c. Loosen cord grip (AD of Figure 19) and remove cord.
3. Remove four (4) screws (P of Figure 20). Detach motor with adapter flange (R) from gear reducer (S). Retain motor output shaft key (T).

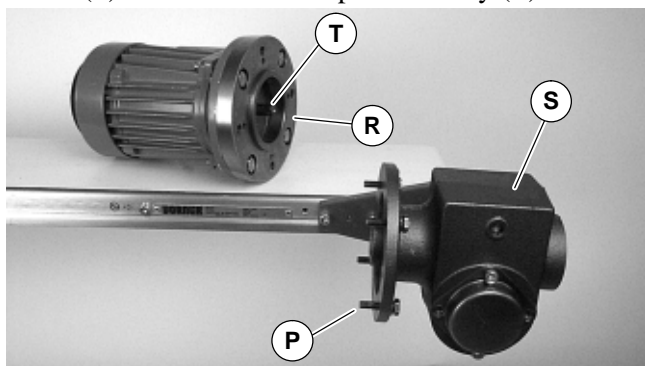

Figure 20

4. Remove four (4) screws and nuts (AE of Figure 21). Remove adapter flange (AF).

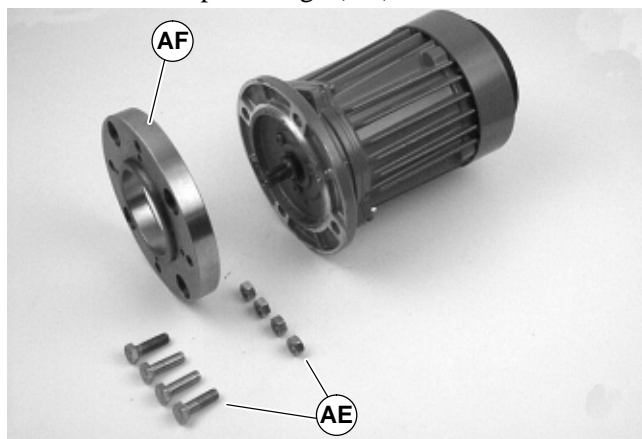

Figure 21

5. Install adapter flange (AF) on new motor. Install screws and nuts (AE) and tighten.

IMPORTANT: Be extremely careful when coupling motor to gear reducer. Avoid misalignment and forcing the connection causing possible permanent gear reducer seal damage.

6. With key (T of Figure 22) in keyway, slide motor with adapter flange (R) and gear reducer together. Install screws (P) and tighten.

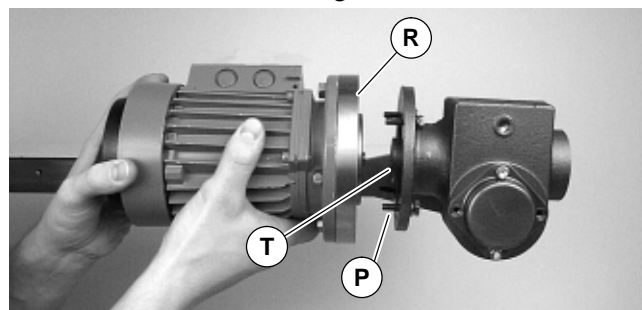

Figure 22

7. Replace wiring:
 - For a single phase motor, reverse step 1 on page 8.
 - For a three phase or VFD variable speed motor, reverse step 2 on this page.

Service Parts

NOTE: For replacement parts other than those shown on this page, contact an authorized Dorner Service Center or the factory.

Item	Part No.	Part Description
1	826-281	Motor, 0.19 Kw 230 Volts, 1400 RPM 50 Hz, 1-Phase
	826-284	Motor, 0.19 Kw 230/400 Volts, 1400 RPM 50 Hz, 3-Phase
2	62Z005HS	Gear Reducer, 5:1, 63B5
	62Z010HS	Gear Reducer, 10:1, 63B5
	62Z020HS	Gear Reducer, 20:1, 63B5
	62Z040HS	Gear Reducer, 40:1, 63B5
	62Z060HS	Gear Reducer, 60:1, 63B5
3	807-995	Coupling
4	450444M	Gear Reducer Shaft
5	912-084	Key, Square, 0.188" x 1.5" L
6	980416M	Key, Square, 4mm x 16mm L

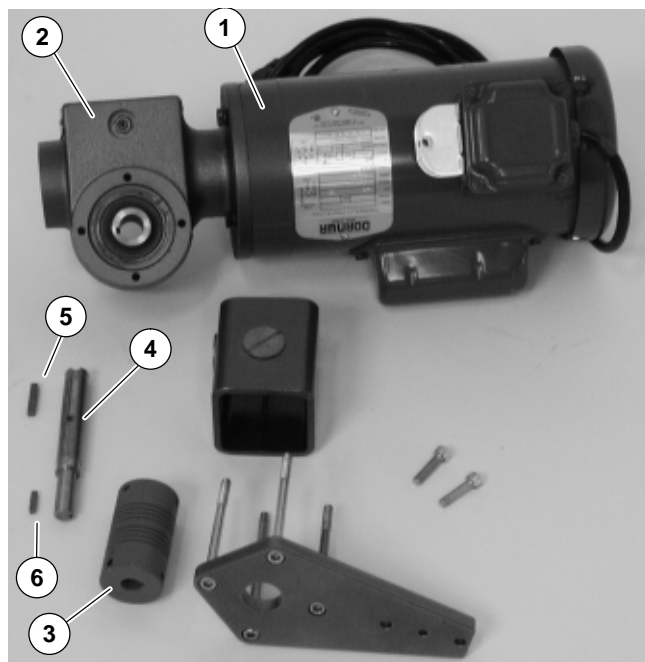

Figure 23

Return Policy

No returns will be accepted without prior written factory authorization. When calling for authorization, please have the following information ready for the Dorner Factory representative or your local distributor:

1. Name and address of customer.
2. Item(s) being returned.
3. Reason for return.
4. Customer's original order number used when ordering the item(s).
5. Dorner or distributor invoice number.

A representative will discuss action to be taken on the Returned items and provide a Returned Goods Authorization Number to reference.

There will be a 15% restocking charge on all new items returned for credit where Dorner was not at fault. These will not be accepted after 60 days from original invoice date. The restocking charge covers inspection, cleaning, disassembly, and reissuing to inventory.

If a replacement is needed prior to evaluation of returned item, a purchase order must be issued. Credit (if any) is issued only after return and evaluation is complete.

Dorner has representatives throughout the world. Feel free to contact Dorner for the name of your local representative. Our technical sales and service staff will gladly help with your questions on Dorner products.

For a copy of Dorner's Limited Warranty, contact factory, distributor, service center or visit our website @ www.dorner.com

DORNER®

Dorner Mfg. Corp. reserves the right to change or discontinue products without notice. All products and services are covered in accordance with our standard warranty. All rights reserved. ©Dorner Mfg. Corp. 2000

DORNER MFG. CORP.

975 Cottonwood Ave. PO Box 20
Hartland, WI 53029-0020 USA

USA
TEL 1-800-397-8664 (USA)
FAX 1-800-369-2440 (USA)

Outside the USA:
TEL 1-262-367-7600, FAX 1-262-367-5827

DORNER

Arnold-Sommerfeld-Ring 2
D-52499 Baesweiler
Germany

TEL (02401) 80 52 90
FAX (02401) 80 52 93

Internet: www.dorner.com