

3200 & LPZ Series Top Mount Parallel Drive Package for Standard Load 60 Hz Gearmotors





Table of Contents

Warnings – General Safety	2	Preventive Maintenance & Adjustment	7
Introduction	2	Required Tools	7
Product Description	3	Timing Belt Tensioning	7
Specifications	3	Timing Belt Replacement	7
Gearmotors	5	Drive or Driven Pulley Replacement	8
3200 Belt Speeds	5	Motor Replacement	8
Installation	5	Service Parts	10
Required Tools	5	Bottom Mount Drive Package	10
Mounting	5	Gearmotors	11
		Return Policy	12

Warnings – General Safety



	WARNING	
<p>The safety alert symbol, black triangle with white exclamation, is used to alert you to potential personal injury hazards.</p>		



	 WARNING
<p>Gearmotors may be HOT. DO NOT TOUCH Gearmotors.</p>	

	 DANGER
<p>Climbing, sitting, walking or riding on conveyor will cause severe injury. KEEP OFF CONVEYORS.</p>	

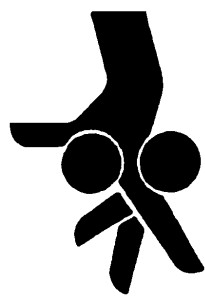
	 WARNING
<p>Exposed moving parts can cause severe injury. REPLACE ALL GUARDS BEFORE RUNNING CONVEYOR.</p>	

	 DANGER
<p>Do NOT OPERATE CONVEYORS IN AN EXPLOSIVE ENVIRONMENT.</p>	

	 WARNING
<p>Dorner cannot control the physical installation and application of conveyors. Taking protective measures is the responsibility of the user.</p> <p>When conveyors are used in conjunction with other equipment or as part of a multiple conveyor system, CHECK FOR POTENTIAL PINCH POINTS and other mechanical hazards before system start-up.</p>	

	 WARNING
<p>Exposed moving parts can cause severe injury. LOCK OUT POWER before removing guards or performing maintenance.</p>	

Introduction

IMPORTANT: Some illustrations may show guards removed. Do NOT operate equipment without guards.

Upon receipt of shipment:

- Compare shipment with packing slip. Contact factory regarding discrepancies.
- Inspect packages for shipping damage. Contact carrier regarding damage.
- Accessories may be shipped loose. See accessory instructions for installation.

Dorner 3200 Series conveyors are covered by patent numbers 5156260, 5156261, 5203447, 5265714 and patent applications in other countries.

Dorner LPZ Series conveyors are covered by patent numbers 5156260, 5156261, 5203447, 5265714, 5875883 and patent applications in other countries.

Dorner's Limited Warranty applies.

Dorner reserves the right to make changes at any time without notice or obligation.

Product Description

Refer to Figure 1 for typical components.

Typical Components	
A	Conveyor
B	Mounting Bracket
C	Gearmotor
D	Timing Belt Tensioner
E	Cover
F	Timing Belt
G	Drive Pulley
H	Driven Pulley

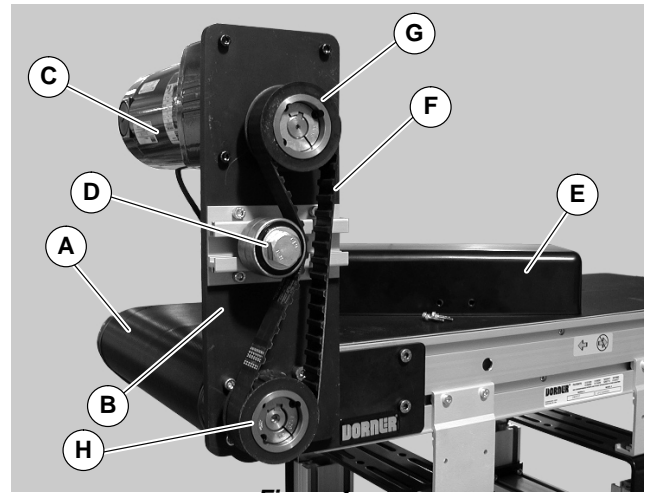

Figure 1

Specifications

Gearmotor Mounting Package Models:

Example:

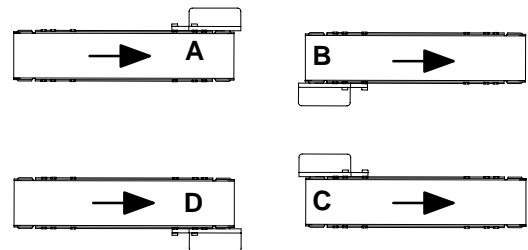
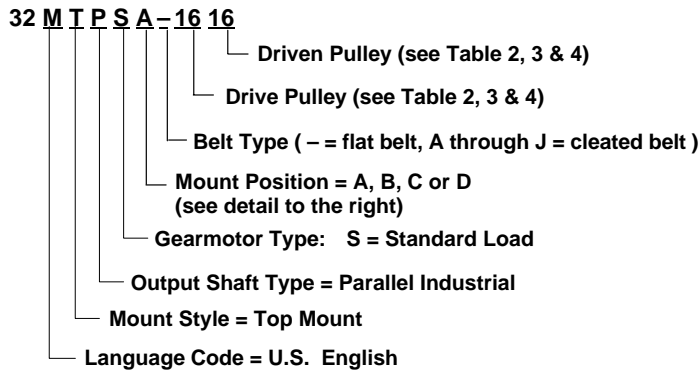

Table 1: Gearmotor Specifications

	Single Phase	Three Phase	DC Variable Speed	VFD Variable Speed
Power/ Gear Ratio	hp (kW)	hp (kW)	hp (kW)	hp (kW)
5:1	.08 (.06)	.17 (.13)	.12 (.09)	.17 (.13)
10:1	.17 (.13)	.17 (.13)	.25 (.19)	.17 (.13)
20:1	.33 (.25)	.38 (.28)	.25 (.19)	.38 (.28)
30:1	.33 (.25)	.38 (.28)	.25 (.19)	.38 (.28)
60:1	.33 (.25)	.38 (.28)	.33 (.25)	.38 (.28)
180:1	.33 (.25)	.38 (.28)	N/A	.38 (.28)
Input Voltage	115 VAC	230 VAC	130 VDC	230 VAC
Input Frequency	60 Hz	60 Hz	N/A	10 to 60 Hz

Specifications

Table 1: Gearmotor Specifications Continued

	Single Phase	Three Phase	DC Variable Speed	VFD Variable Speed
Input Current/ Gear Ratio	FLA	FLA	FLA	FLA
5:1	1.2	1.0	1.0	1.0
10:1	1.9	1.0	1.8	1.0
20:1	4	1.9	1.8	1.9
30:1	4	1.9	1.8	1.9
60:1	4	1.9	2.3	1.9
180:1	4	1.9	N/A	1.9
Motor RPM	1725	1725	2500	1725
Power/Ratio	Totally Enclosed	Fan Cooled	Totally Enclosed Non-Ventilated	Totally Enclosed Fan Cooled

Table 2: Belt Speeds for Fixed Speed Parallel Shaft 60 Hz Gearmotors

Standard Load Gearmotors				Belt Speed		Drive Pulley	Driven Pulley
Part Number	RPM	In-lb	N-m	Ft/min	M/min		
62M180PS4vpFn	10	226		7.6	2.3	16	16
62M180PS4vpFn	10	226		11.4	3.5	24	16
62M060PS4vpFn	29	237		22.9	7.0	16	16
32M030PS4vpFn	58	142		45.8	14.0	16	16
32M020PS4vpFn	86	78		68.6	20.9	16	16
32M020PS4vpFn	86	78		103.0	31.4	24	16
32M010PS4vpFn	173	41		137.3	41.9	16	16
32M010PS4vpFn	173	41		171.6	52.3	20	16
32M010PS4vpFn	173	41		205.9	62.8	24	16
32M005PS4vpFn	345	41		274.6	83.7	16	16
32M005PS4vpFn	345	41		343.2	104.6	20	16
32M005PS4vpFn	345	41		411.9	125.6	24	16

(vp) = voltage and phase
 11 = 115 V, 1-phase
 23 = 208 – 230/460 V, 3-phase

Table 3: Belt Speeds for Variable Speed Parallel Shaft VFD Gearmotors

Standard Load Gearmotors				Belt Speed		Drive Pulley	Driven Pulley
Part Number	RPM	In-lb	N-m	Ft/min	M/min		
62M180PS4vpFn	10	226		1.3–7.6	0.4–2.3	16	16
62M060PS4vpFn	29	237		3.8–22.9	1.2–7.0	16	16
32M030PS4vpFn	58	142		7.6–45.8	2.3–14.0	16	16
32M020PS4vpFn	86	78		11.5–68.6	3.5–20.9	16	16
32M020PS4vpFn	86	78		17.2–103.0	5.2–31.4	24	16
32M010PS4vpFn	173	41		22.9–137.3	7.0–41.9	16	16
32M010PS4vpFn	173	41		34.4–205.9	10.5–62.8	24	16
32M005PS4vpFn	345	41		45.9–274.6	14.0–83.7	16	16
32M005PS4vpFn	345	41		57.3–343.2	17.5–104.6	20	16
32M005PS4vpFn	345	41		68.8–411.9	21.0–125.6	24	16

Table 4: Belt Speeds for Variable Speed Parallel Shaft DC Gearmotors

Standard Load Gearmotors				Belt Speed		Drive Pulley	Driven Pulley
Part Number	RPM	In-lb	N-m	Ft/min	M/min		
62M180PSD3DEN	14	226		1.3–11.1	0.4–3.4	16	16
62M180PSD3DEN	14	226		2.0–16.6	0.6–5.1	24	16
62M060PSD3DEN	42	237		4.0–33.2	1.2–10.1	16	16
62M030PSD3DEN	83	142		8.0–66.3	2.4–20.2	16	16
62M020PSD3DEN	125	78		11.9–99.5	3.6–30.3	16	16
62M020PSD3DEN	125	78		17.9–149.2	5.5–45.5	24	16
62M010PSD3DEN	250	41		23.9–199.0	7.3–60.7	16	16
62M010PSD3DEN	250	41		29.8–248.7	9.1–75.8	20	16
62M010PSD3DEN	250	41		35.8–298.5	10.9–91.0	24	16

NOTE: For belt speed other than those listed, contact factory for details.

Installation

Required Tools

- Hex key wrenches:
2 mm, 2.5 mm, 3 mm, 5 mm
- Straight edge
- Torque wrench

Mounting

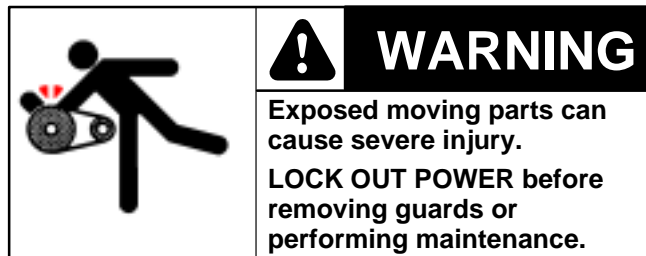

Installation Component List	
E	Cover
F	Timing Belt
G	Drive Pulley
H	Driven Pulley
I	Top Mount Drive Assembly
J	Cover Screws
K	Key
L	M6 Socket Head Screws (4x)
M	M8 Socket Head Screws (2x)
N	Tensioner

1. Typical components (Figure 2)

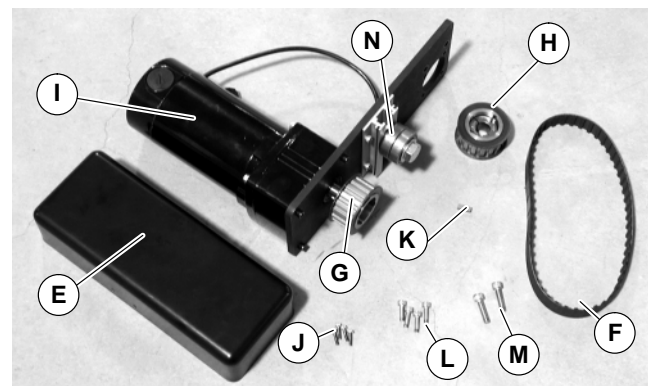

Figure 2

NOTE: Cleated belt mounting package shown, flat belt mounting package similar.

2. Locate drive output shaft (Q of Figure 3). Remove two (2) M8 screws (P) and four (4) M6 screws (O) and discard.

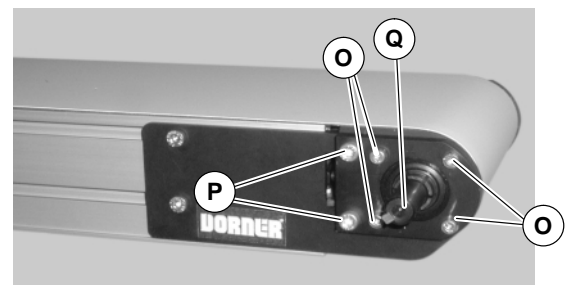

Figure 3

Installation

- Attach top mount drive assembly (B of Figure 4) with two (2) M8 screws (M) and four (4) M6 screws (L). Tighten M6 screws (L) to 146 in-lbs (16.5 N-m) and M8 screws (M) to 288 in-lbs (32.5 N-m).

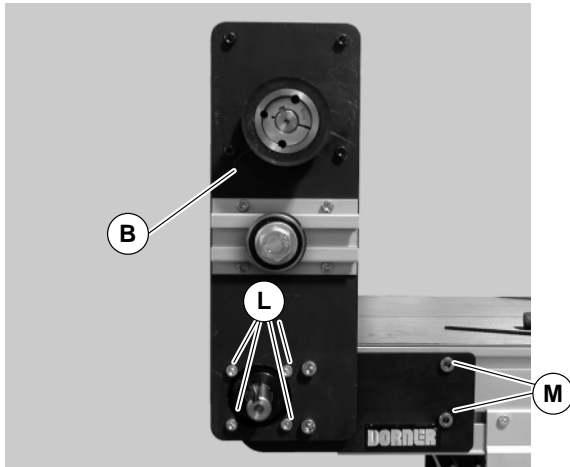

Figure 4

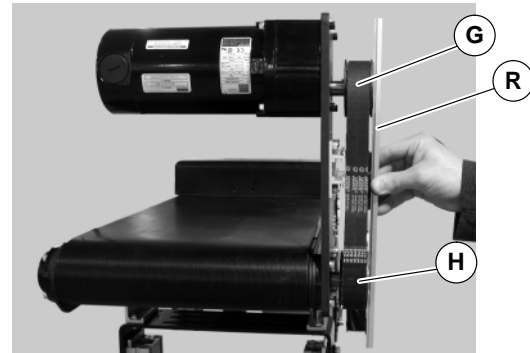

Figure 6

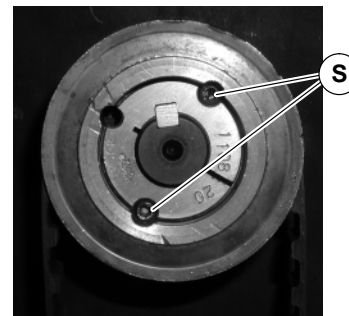

Figure 7



- Install key (K of Figure 5).

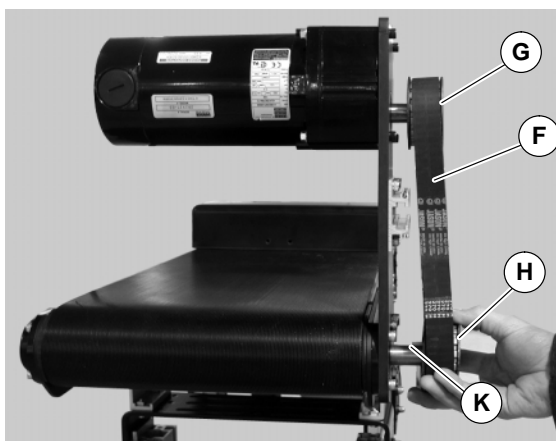

Figure 5

- Wrap timing belt (F) around driven pulley (H) and drive pulley (G). Install driven pulley (H) onto conveyor shaft.
- Using a straight edge (R of Figure 6), align driven pulley (H) with drive pulley (G). Tighten driven pulley taper-lock screws (S of Figure 7).

- Depending on conveyor belt travel (direction 1 or 2), locate timing belt tensioner (N of Figure 8) as shown. Tension timing belt to obtain 1/8" (3 mm) deflection for 6 lb (3 Kg) of force at timing belt mid-point (T). Tighten tensioner screw to 110 in-lb (12 Nm).

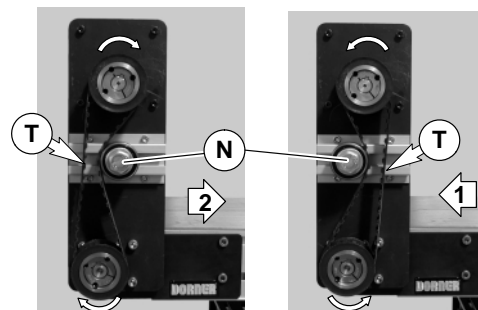

Figure 8

- Install cover (E of Figure 9) with four (4) screws (J). Tighten screws to 35 in-lb (4 Nm).

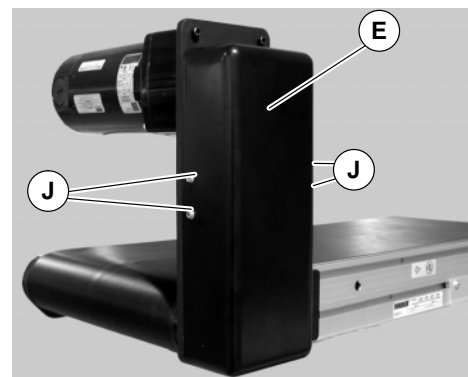

Figure 9

Preventive Maintenance and Adjustment

Required Tools

- Hex key wrenches:
2 mm, 2.5 mm, 3 mm, 5 mm
- Adjustable wrench (for hexagon head screws)
- Straight edge
- Torque wrench

Timing Belt Tensioning



1. Remove four (4) screws (J of Figure 9) and remove cover (E).
2. Loosen tensioner (N of Figure 10).

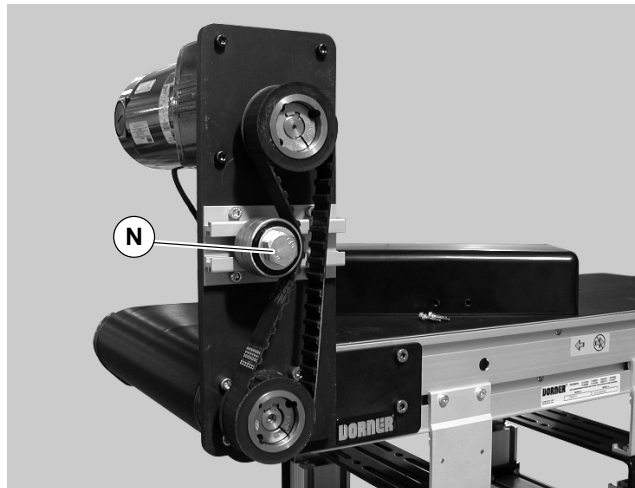
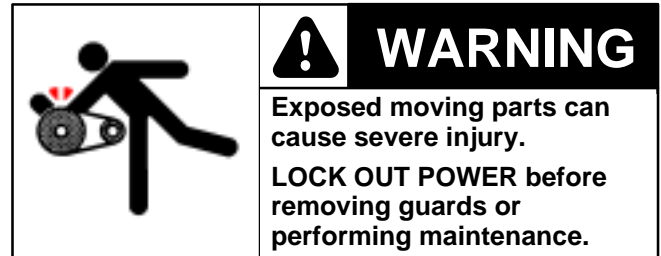

Figure 10

3. Depending on conveyor belt travel (direction 1 or 2), locate timing belt tensioner (N of Figure 8) as shown. Tension timing belt to obtain 1/8" (3 mm) deflection for 6 lb (3 Kg) of force at timing belt mid-point (T). Tighten tensioner screw to 110 in-lb (12 Nm).
4. Install cover (E of Figure 9) with four (4) screws (J). Tighten screws to 35 in-lb (4 Nm).

Timing Belt Replacement



1. Remove four (4) screws (J of Figure 9) and remove cover (E).
2. Loosen tensioner (N of Figure 10).
3. Remove timing belt (F of Figure 11).

NOTE: If timing belt does not slide over pulley flange, loosen driven pulley taper-lock screws (S of Figure 7 & 11) and remove pulley with belt (F). For re-installation, see steps 5 and 6 on page 6.

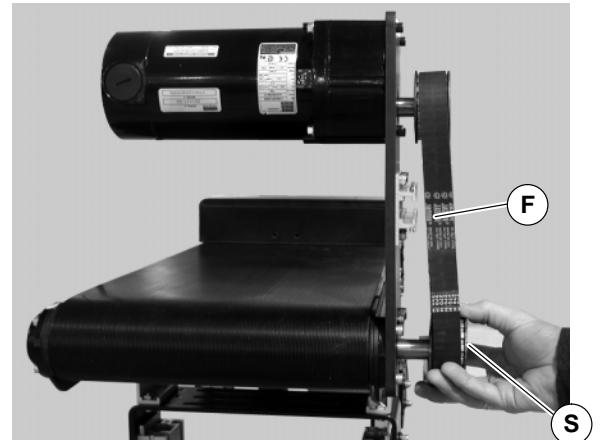

Figure 11

4. Install new timing belt.
5. Depending on conveyor belt travel (direction 1 or 2), locate timing belt tensioner (N of Figure 8) as shown. Tension timing belt to obtain 1/8" (3 mm) deflection for 6 lb (3 Kg) of force at timing belt mid-point (T). Tighten tensioner screw to 110 in-lb (12 Nm).
6. Install cover (E of Figure 9) with four (4) screws (J). Tighten screws to 35 in-lb (4 Nm).

Preventive Maintenance and Adjustment

Drive or Driven Pulley Replacement



1. Complete steps 1 through 3 of “Timing Belt Replacement” section on page 7.
2. Remove taper-lock screws (S of Figure 12). Insert one (1) of taper lock screws (S of Figure 12) in remaining hole (U). Tighten screw (S) until pulley is loose. Remove pulley and taper hub assembly.

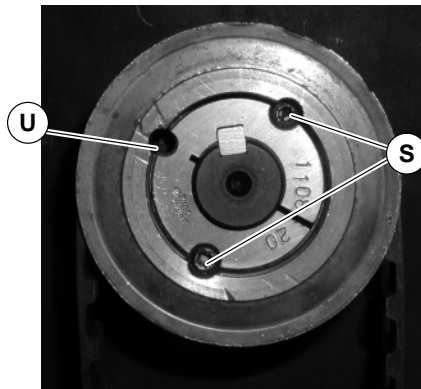
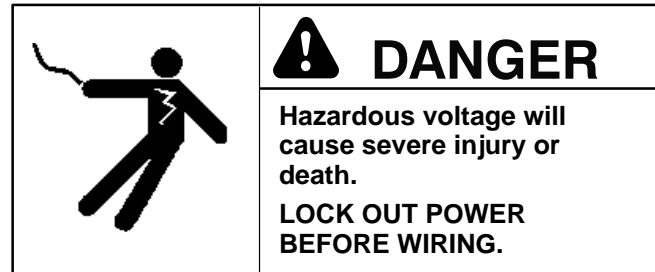
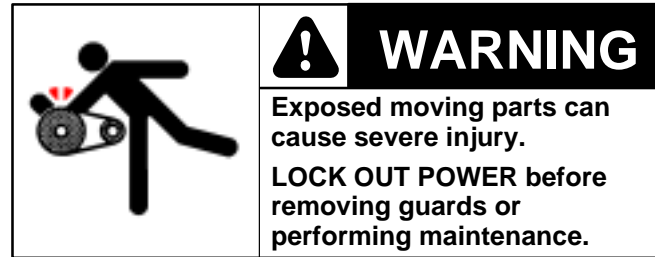

Figure 12

NOTE: If drive pulley (G of Figure 5) is replaced, wrap timing belt around drive pulley and complete step 3.

3. Complete steps 5 through 8 of “Installation” section beginning on page 6.

Motor Replacement



1. For single phase motor, unplug power cord from outlet.
2. For three phase and VFD variable speed motor:
 - a. Loosen terminal box screws (V of Figure 13) and remove cover (W).

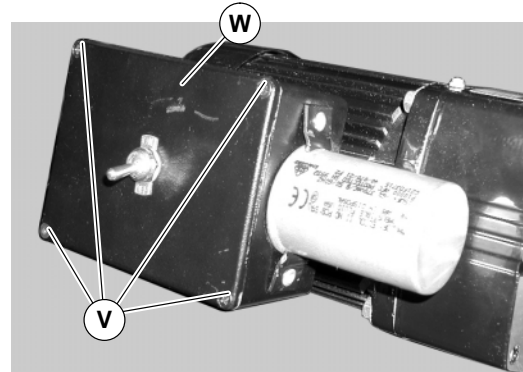

Figure 13

- b. Record incoming wire colors on red, black and blue leads. Loosen wire nuts and remove incoming wires.
- c. Loosen cord grip and remove cord.

Preventive Maintenance and Adjustment

3. For DC variable speed motor, unplug motor cord at disconnect (X of Figure 14).

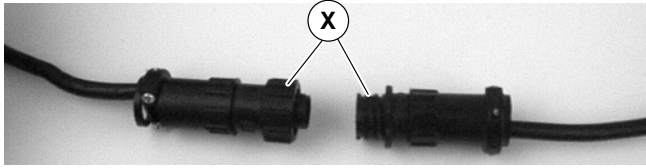

Figure 14

4. Remove the drive pulley see steps 1 and 2 of “Drive or Driven Pulley Replacement” section on page 8.
5. Remove four (4) screws (J of Figure 15). Detach motor (C) from the mounting plate (B). Retain motor output shaft key (K).

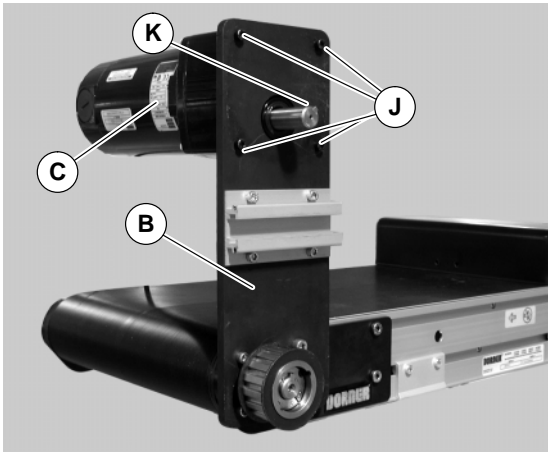

Figure 15

6. Install new motor using the four (4) mounting screws (J of Figure 15).
7. Re-install the drive pulley reverse step 2 of “Drive or Driven Pulley Replacement” section on page 8.
8. Complete steps 5 through 8 of “Installation” section beginning on page 6.
9. Replace wiring:
- For a single phase motor, reverse step 1 on this page.
 - For a three phase or VFD variable speed motor, reverse step 2 on this page.
 - For a DC variable speed motor, reverse step 3 on this page.

Service Parts

NOTE: For replacement parts other than those shown in this section, contact an authorized Dorner Service Center or Dorner Manufacturing.

3200 Series Conveyors Top Mount Parallel Drive Package for Standard Load Industrial Gearmotors

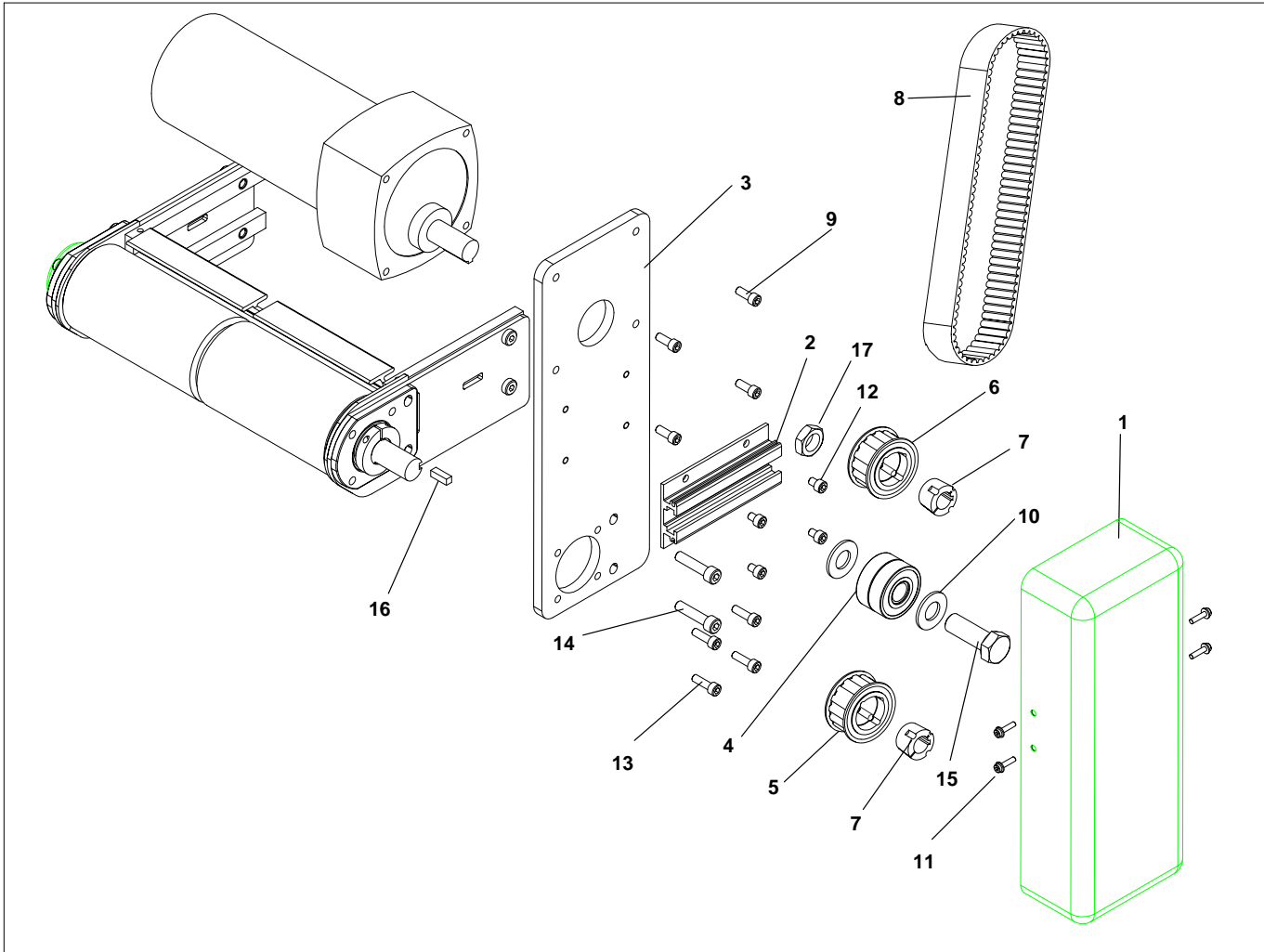

Item	Part Number	Description
1	300871	Drive Cover
	300349	Drive Cover (Flat Belt)
2	301076	Drive Tensioner Slide
3	301152	Mounting Plate
	301154	Mounting Plate (Flat Belt)
4	301153	Tensioner Bearing Assy
5	811-123	Driven Pulley, 14 Tooth, Taper Lock TL1108
	811-126	Driven Pulley, 16 Tooth, Taper Lock TL1108
6	811-126	Drive Pulley, 16 Tooth, Taper Lock TL1108

	811-127	Drive Pulley, 18 Tooth, Taper Lock TL1210
	811-135	Drive Pulley, 20 Tooth, Taper Lock TL1210
	811-136	Drive Pulley, 22 Tooth, Taper Lock TL1610
	811-137	Drive Pulley, 24 Tooth, Taper Lock TL1610
7	811-288	Taper Lock Bushing, 20MM, TL1108
	811-289	Taper Lock Bushing, 20MM, TL1210
	811-290	Taper Lock Bushing, 20MM, TL1610
8	814-059	Timing Belt, 1.0" W x 27.0" L
	814-060	Timing Belt, 1.0" W x 28.0" L

9	902-130	Cap Head Screw 1/4-20 x 0.62"
10	911-013	Flat Washer
11	920843M	Flange Socket Head Screw M4 x 16mm
12	920608M	Socket Head Screw M6 x 8mm
13	920620M	Socket Head Screw M6 x 20mm

14	920835M	Socket Head Screw M8 x 35mm
15	961645M	Socket Head Screw M16 x 45mm
16	980636M	Square Key
17	991610M	Hex Jam Nut M16

3200 Standard Load Parallel Shaft Industrial Gearmotors

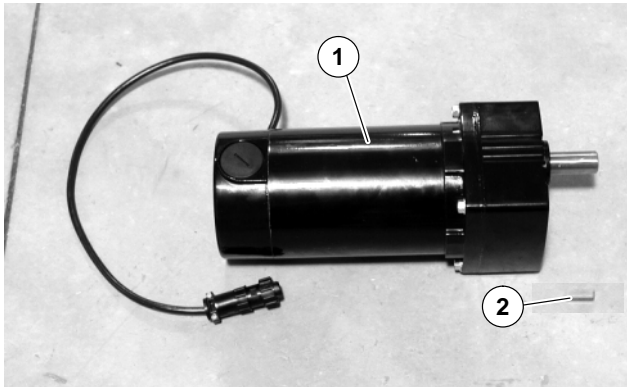

Figure 16

Item	Part No.	Part Description
1	62M180PS411FN	Motor, 0.08hp (0.06Kw), 115 Volts, 60 Hz, 1-Phase
	62M180PS411FR	Motor, 0.08hp (0.06Kw), 115 Volts, 60 Hz, 1-Phase with Reversing
	62M180PS423FN	Motor, 0.17hp (0.13Kw), 208-230/460 Volts, 60 Hz, 3-Phase
	62M060PS411FN	Motor, 0.17hp (0.13Kw), 115 Volts, 60 Hz, 1-Phase
	62M060PS411FR	Motor, 0.17hp (0.13Kw), 115 Volts, 60 Hz, 1-Phase with Reversing
	62M060PS423FN	Motor, 0.17hp (0.13Kw), 208-230/460 Volts, 60 Hz, 3-Phase
	62M030PS411FN	Motor, 0.33hp (0.25Kw), 115 Volts, 60 Hz, 1-Phase
	62M030PS411FR	Motor, 0.33hp (0.25Kw), 115 Volts, 60 Hz, 1-Phase with Reversing
	62M030PS423FN	Motor, 0.38hp (0.28Kw), 208-230/460 Volts, 60 Hz, 3-Phase
	62M020PS411FN	Motor, 0.33hp (0.25Kw), 115 Volts, 60 Hz, 1-Phase
	62M020PS411FR	Motor, 0.33hp (0.25Kw), 115 Volts, 60 Hz, 1-Phase with Reversing
	62M020PS423FN	Motor, 0.38hp (0.28Kw), 208-230/460 Volts, 60 Hz, 3-Phase
	62M010PS411FN	Motor, 0.33hp (0.25Kw), 115 Volts, 60 Hz, 1-Phase
	62M010PS411FR	Motor, 0.33hp (0.25Kw), 115 Volts, 60 Hz, 1-Phase with Reversing
	62M010PS423FN	Motor, 0.38hp (0.28Kw), 208-230/460 Volts, 60 Hz, 3-Phase
	62M005PS411FN	Motor, 0.33hp (0.25Kw), 115 Volts, 60 Hz, 1-Phase
	62M005PS411FR	Motor, 0.33hp (0.25Kw), 115 Volts, 60 Hz, 1-Phase with Reversing
	62M005PS423FN	Motor, 0.38hp (0.28Kw), 208-230/460 Volts, 60 Hz, 3-Phase
	62M180PSD3DEN	Motor, 0.12 (0.09 Kw), 130 Volts DC
	62M060PSD3DEN	Motor, 0.25 (0.19 Kw), 130 Volts DC
	62M030PSD3DEN	Motor, 0.25 (0.19 Kw), 130 Volts DC
	62M020PSD3DEN	Motor, 0.25 (0.19 Kw), 130 Volts DC
	62M010PSD3DEN	Motor, 0.33 (0.25 Kw), 130 Volts DC
	62M180PS423EN	Motor, 0.17 (0.13 Kw), 230 Volts, 60 Hz, 3-Phase VFD
	62M060PS423EN	Motor, 0.17 (0.13 Kw), 230 Volts, 60 Hz, 3-Phase VFD
	62M030PS423EN	Motor, 0.38 (0.28 Kw), 230 Volts, 60 Hz, 3-Phase VFD
	62M020PS423EN	Motor, 0.38 (0.28 Kw), 230 Volts, 60 Hz, 3-Phase VFD
	62M010PS423EN	Motor, 0.38 (0.28 Kw), 230 Volts, 60 Hz, 3-Phase VFD
2	917-078	Key, Square, 0.188" x 0.75" L

Return Policy

No returns will be accepted without prior written factory authorization. When calling for authorization, please have the following information ready for the Dorner Factory representative or your local distributor:

1. Name and address of customer.
2. Item(s) being returned.
3. Reason for return.
4. Customer's original order number used when ordering the item(s).
5. Dorner or distributor invoice number.

A representative will discuss action to be taken on the Returned items and provide a Returned Goods Authorization Number to reference.

There will be a 15% restocking charge on all new items returned for credit where Dorner was not at fault. These will not be accepted after 60 days from original invoice date. The restocking charge covers inspection, cleaning, disassembly, and reissuing to inventory.

If a replacement is needed prior to evaluation of returned item, a purchase order must be issued. Credit (if any) is issued only after return and evaluation is complete.

Dorner has representatives throughout the world. Feel free to contact Dorner for the name of your local representative. Our technical sales and service staff will gladly help with your questions on Dorner products.

For a copy of Dorner's Limited Warranty, contact factory, distributor, service center or visit our website at www.dorner.com.

DORNER[®]

Dorner Mfg. Corp. reserves the right to change or discontinue products without notice. All products and services are covered in accordance with our standard warranty. All rights reserved. © Dorner Mfg. Corp. 2000

DORNER MFG. CORP.

975 Cottonwood Ave. PO Box 20
Hartland, WI 53029-0020 USA

USA
TEL 1-800-397-8664 (USA)
FAX 1-800-369-2440 (USA)
Internet: www.dorner.com

Outside the USA:
TEL 1-262-367-7600, FAX 1-262-367-5827