

## Low Height Stands





## Table of Contents

WARNINGS – General Safety .....	2	Optional Caster Kit .....	6
Introduction .....	2	Required Tools .....	6
Product Description .....	3	Preventative Maintenance & Adjustment .....	7
Specifications .....	3	Stand Height Adjustment .....	7
Installation .....	4	Required Tools .....	7
Recommended Installation Sequence .....	4	Conveyor Angle Adjustment .....	8
Required Tools .....	4	Required Tools .....	8
Assembly: Stands Shipped Partially Assembled ..	4	Service Parts .....	10
Assembly: Stands Shipped Fully Assembled ....	6	Return Policy .....	12

# Warnings - General Safety

	<b>WARNING</b>	
<p>The safety alert symbol, black triangle with white exclamation, is used to alert you to potential personal injury hazards.</p>		

	<b>WARNING</b>
<p>Loosening stand height or angle adjustment screws may cause conveyor sections to drop down, causing severe injury.</p> <p><b>SUPPORT CONVEYOR SECTIONS PRIOR TO LOOSENING STAND HEIGHT OR ANGLE ADJUSTMENT SCREWS.</b></p>	

	<b>DANGER</b>
<p>Climbing, sitting, walking or riding on conveyor will cause severe injury.</p> <p><b>KEEP OFF CONVEYORS.</b></p>	

	<b>WARNING</b>
<p>Dorner cannot control the physical installation and application of conveyors. Taking protective measures is the responsibility of the user.</p> <p>When conveyors are used in conjunction with other equipment or as part of a multiple conveyor system, <b>CHECK FOR POTENTIAL PINCH POINTS</b> and other mechanical hazards before system start-up.</p>	

	<b>DANGER</b>
<p><b>DO NOT OPERATE CONVEYORS IN AN EXPLOSIVE ENVIRONMENT.</b></p>	

	<b>WARNING</b>
<p>Exposed moving parts can cause severe injury.</p> <p><b>LOCK OUT POWER</b> before removing guards or performing maintenance.</p>	

## Introduction

**IMPORTANT:** Some illustrations may show guards removed. Do NOT operate equipment without guards.

Upon receipt of shipment:

- Compare shipment with packing slip. Contact factory regarding discrepancies.

- Inspect packages for shipping damage. Contact carrier regarding damage.
- Accessories may be shipped loose. See accessory instructions for installation.

Dorner's Limited Warranty applies.

Dorner reserves the right to make changes at any time without notice or obligation.

# Product Description

Refer to Figure 1 for typical stand components.

Typical Components	
A	Crossmember
B	Stand Mounting Bracket (with Conveyor)
C	Leg Assembly (2x)
D	Height Adjustment Point
E	Angle Adjustment Point

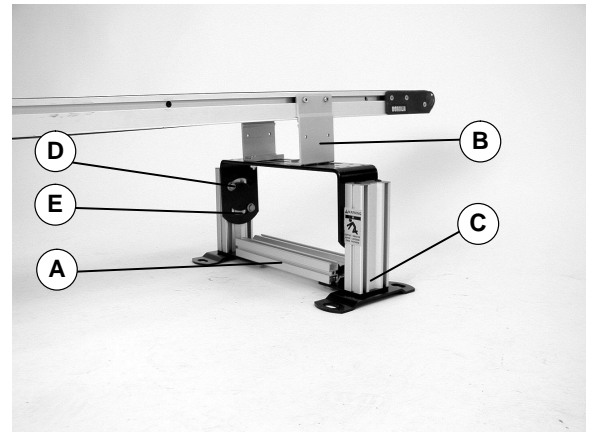
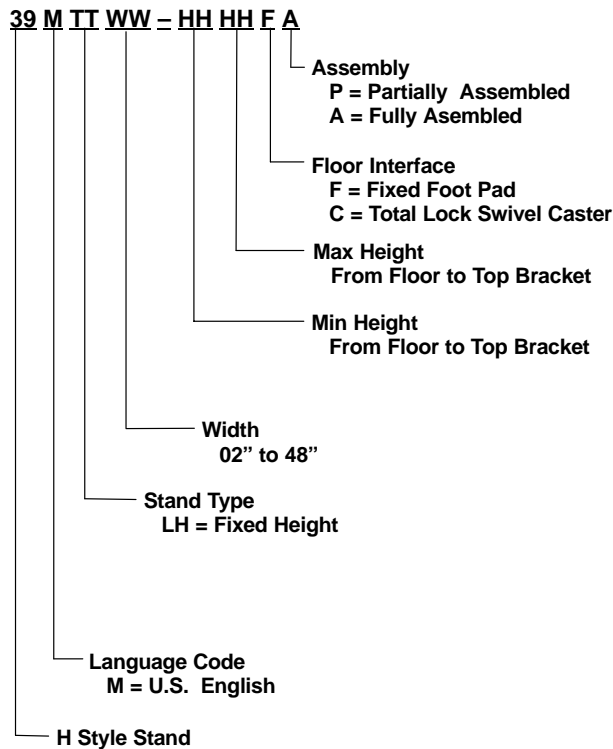

Figure 1

# Specifications

## Low Height Stand Models



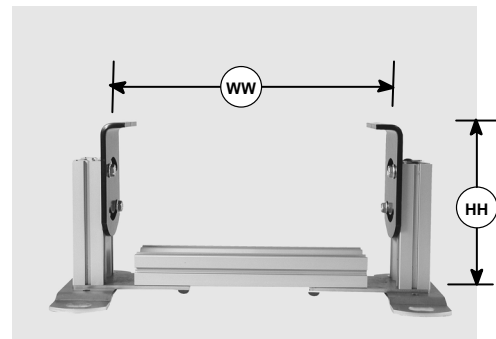

Example: 39MLH12-1012FP

Low height, H style stand for 12" wide conveyors with a minimum height of 10" and a maximum height of 12" with fixed foot pads. It comes partially assembled and has U.S. English documentation.



# Installation





## WARNING

Exposed moving parts can cause severe injury.  
**LOCK OUT POWER** before removing guards or performing maintenance.

## Recommended Installation Sequence (see Table of Contents for page numbers)

- Assemble stand, if required
- Attach stand(s) to conveyor (see Conveyor Installation Maintenance & Parts Manual)
- Adjust stand height and level (see Adjustment section, page 7)

## Required Tools

- 6 mm Hex Key Wrench
- 10 mm Open End Wrench

## Assembly

### Stands Shipped Partially Assembled

1. Typical components (Figure 2).

Typical Components	
G	Crossmember
H	Conveyor Mounting Brackets (2 possible configurations)
I	Leg Assembly (2x)
J	End Caps (2x)
K	Push Screws (4x)
L	Hardware Pack

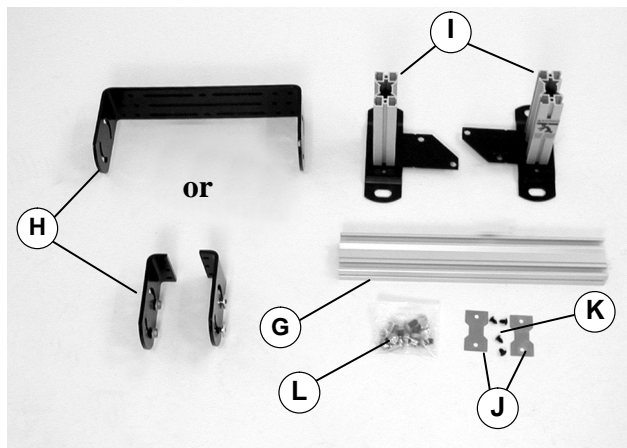

**Figure 2**

2. Open fastener bag (L of Figure 2)

3. Install one (1) hex nut (M of Figure 3) into each crossmember (G) t-slot (N).

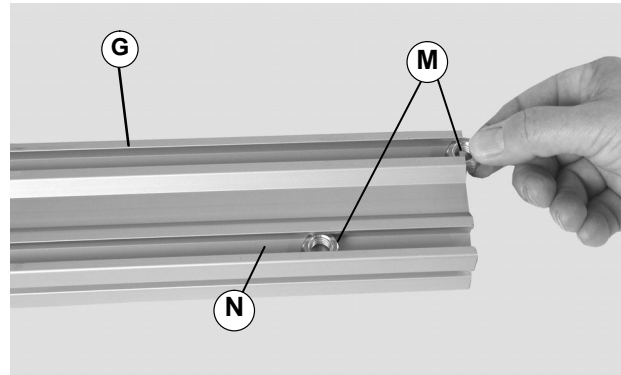

**Figure 3**

4. Align hex nuts (M of Figure 4) with leg holes (P). Attach leg assembly (I) to cross tube (G) with button screws (O). Do not tighten screws.

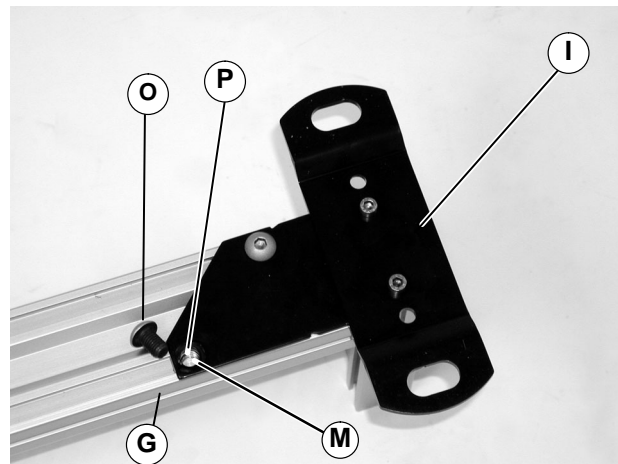

**Figure 4**

5. Align notch (Q of Figure 5) on leg assembly with edge of crossmember (G).

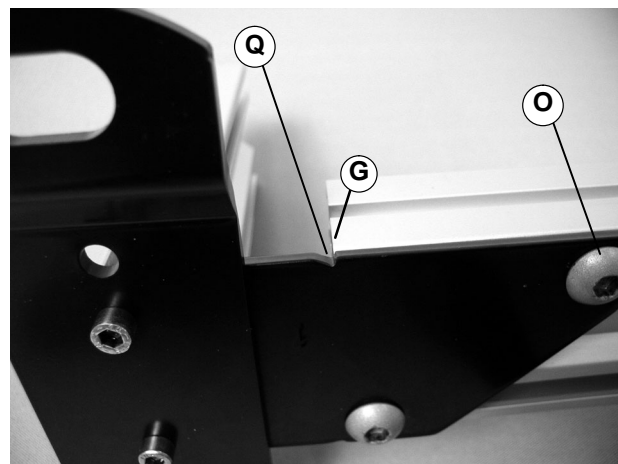

**Figure 5**

6. Tighten button screws (O of Figure 5) to 150 in-lb (17 N-m).

7. Repeat steps 3 through 6 on opposite end of crossmember.
8. Attach nut (S of Figure 6) and flange head hex screw (R) to each slot of conveyor mounting bracket (H).

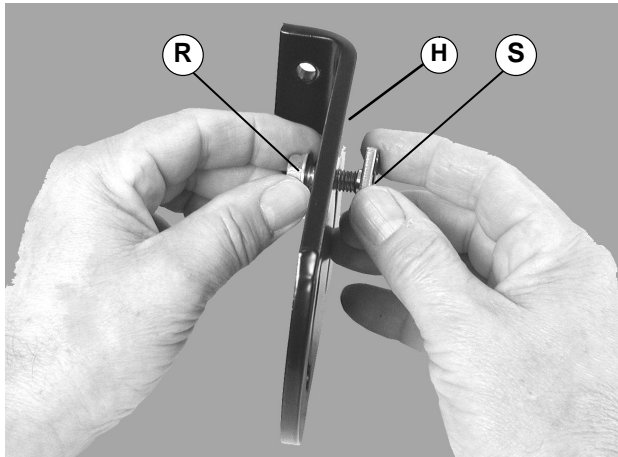

**Figure 6**

9. Align nuts (S of Figure 7) with inside t-slots on leg assembly (N). Slide nut into t-slot.

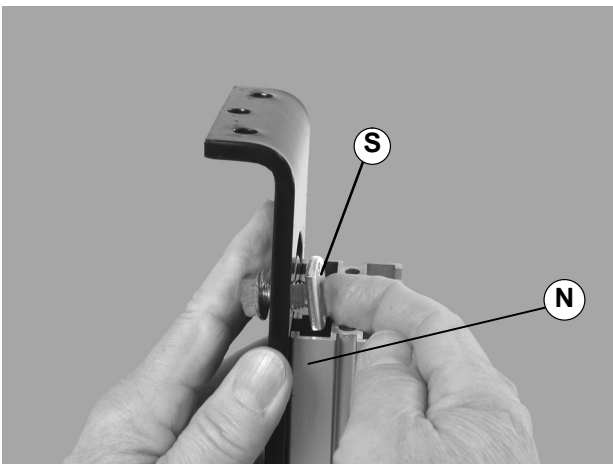

**Figure 7**

		<h2>WARNING</h2>
<p>Failure to secure screws (R of Figure 8) may cause conveyor sections to drop down causing severe injury.</p> <p><b>TIGHTEN SCREWS (R) AFTER ADJUSTMENT.</b></p>		

10. Adjust bracket angle and height. Tighten bracket flange head hex screws (R of Figure 8). Tighten screws to 150 in-lb (17 N-m).

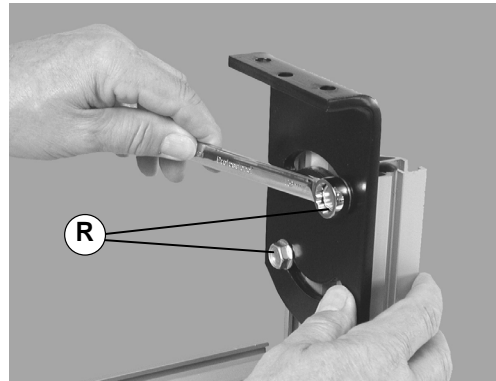

**Figure 8**

11. Repeat steps 8 through 10 on opposite mounting bracket.
12. Align end cap (J of Figure 9) with top of leg assembly (I).

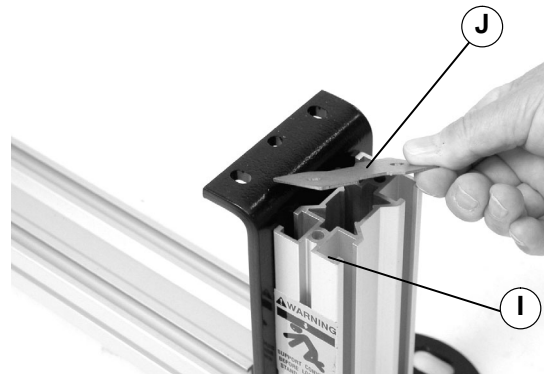

**Figure 9**

13. Attach end cap (J of Figure 10) to leg by inserting push screws (K) through holes in end caps and into leg assembly holes.

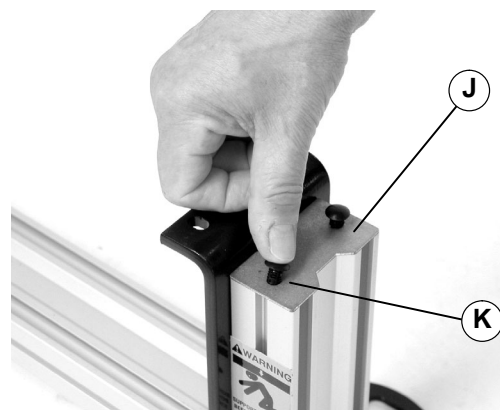

**Figure 10**

14. Repeat steps 12 and 13 on opposite leg assembly.

# Installation

## Stands Shipped Fully Assembled

1. No assembly is required.

## Optional Caster Kit

### Required Tools

- 17 mm Open End Wrench

### Typical Components

- |                                  |             |
|----------------------------------|-------------|
| U                                | Caster (2x) |
| T                                | Nut (2x)    |
| (Discard enclosed carriage bolt) |             |

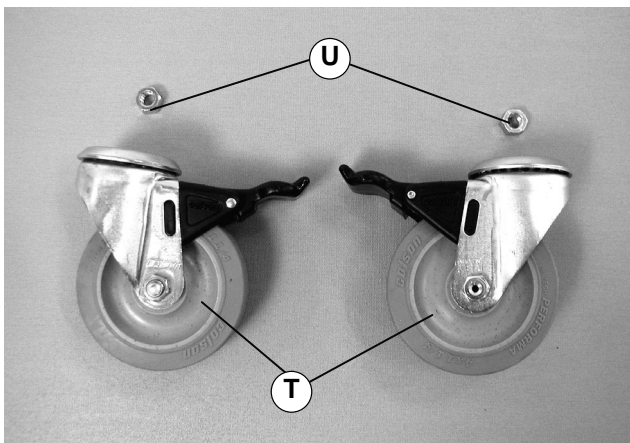

Figure 11

1. Install caster (T of Figure 12) over bolt (V). Bolt is already assembled in stand leg (W) and through the tie plate (X).

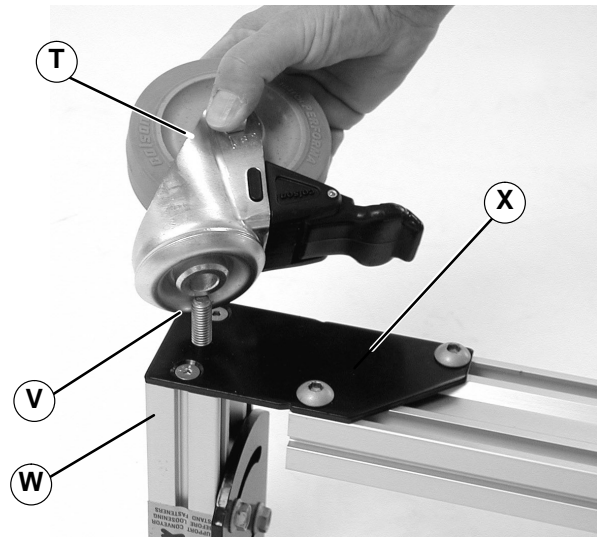

Figure 12

2. Place nut (Y of Figure 13) on bolt (V). Tighten nut to 177 in-lb (20 N-m).

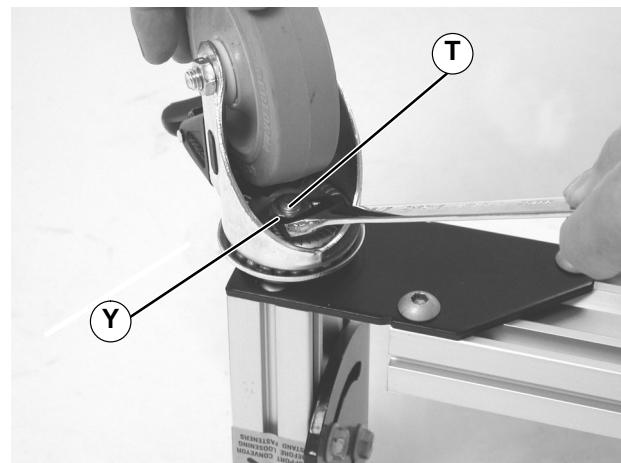

Figure 13

3. Repeat steps 1 and 2 on opposite leg.

# Preventive Maintenance and Adjustment

## Stand Height Adjustment

### Required Tools

- 10 mm Open End Wrench

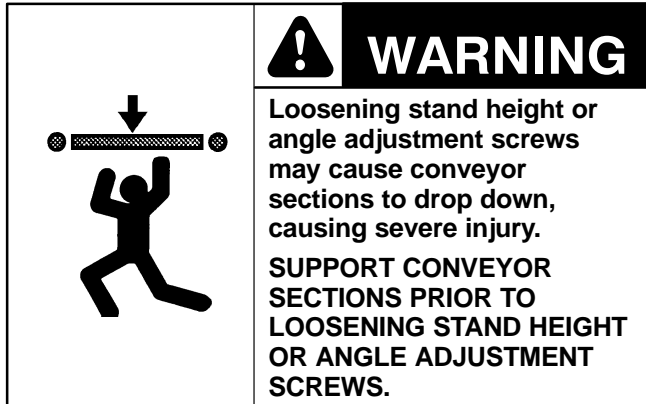
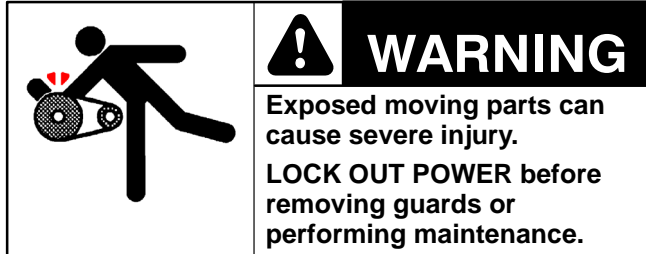

1. Loosen mounting bracket (H of Figure 14) flange head hex screws (R).

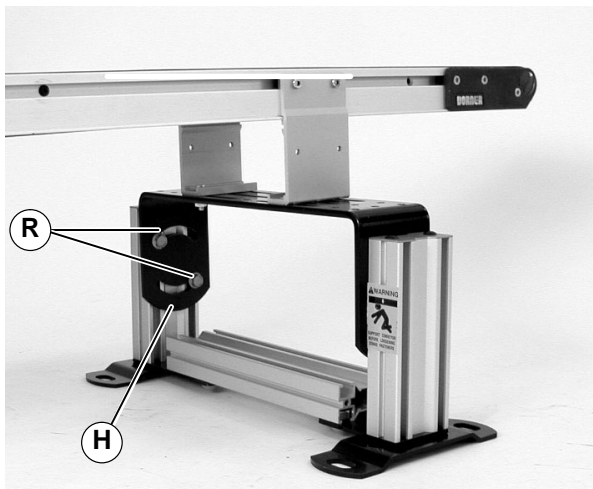
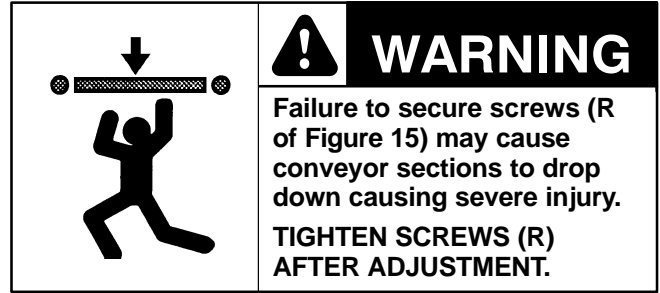

Figure 14

2. Raise or lower mounting bracket (H) to the required height.



3. Tighten flange head hex screws (R of Figure 15) to 150 in-lb (17 N-m).

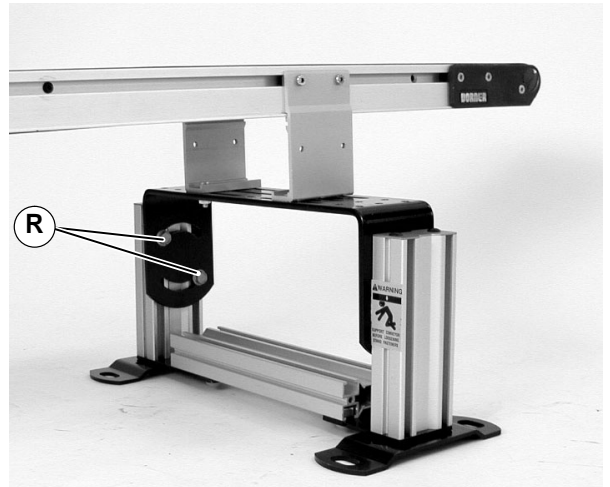

Figure 15

4. Repeat steps 1 through 3 on opposite stand leg.

# Preventive Maintenance and Adjustment

## Conveyor Angle Adjustment

### Required Tools

- 10 mm Open End Wrench

	<p><b>! WARNING</b></p> <p>Loosening stand height or angle adjustment screws may cause conveyor sections to drop down, causing severe injury.</p> <p><b>SUPPORT CONVEYOR SECTIONS PRIOR TO LOOSENING STAND HEIGHT OR ANGLE ADJUSTMENT SCREWS.</b></p>
---	---

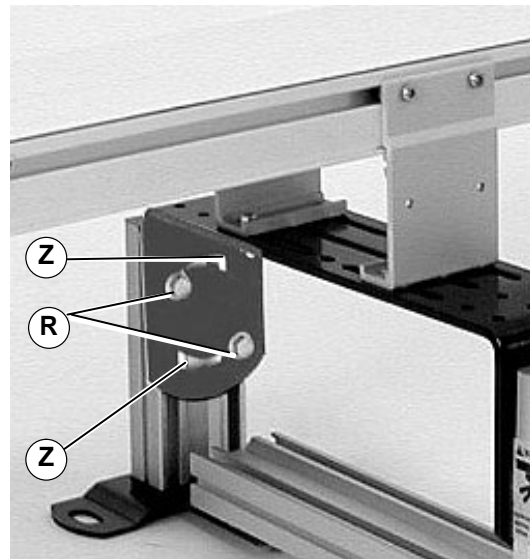
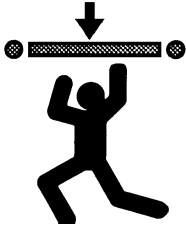

Figure 16

**NOTE:** To rotate stand top plate, screws (R of Figure 16) may need to be re-located to t-slots (Z).

1. Loosen flange head hex screws (R of Figure 16) on both sides of stand.

2. Adjust conveyor to desired angle.

	<p><b>! WARNING</b></p> <p>Failure to secure screws (R of Figure 16) may cause conveyor sections to drop down, causing severe injury.</p> <p><b>TIGHTEN ALL SCREWS (R) AFTER ADJUSTMENT.</b></p>
---	--

3. Secure screws (R of Figure 16) to 150 in-lb (17 N-m).





# Service Parts

**NOTE:** For replacement parts other than those shown, contact an authorized Dorner Service Center or the factory.

## Low Height Stand w/Feet or Casters

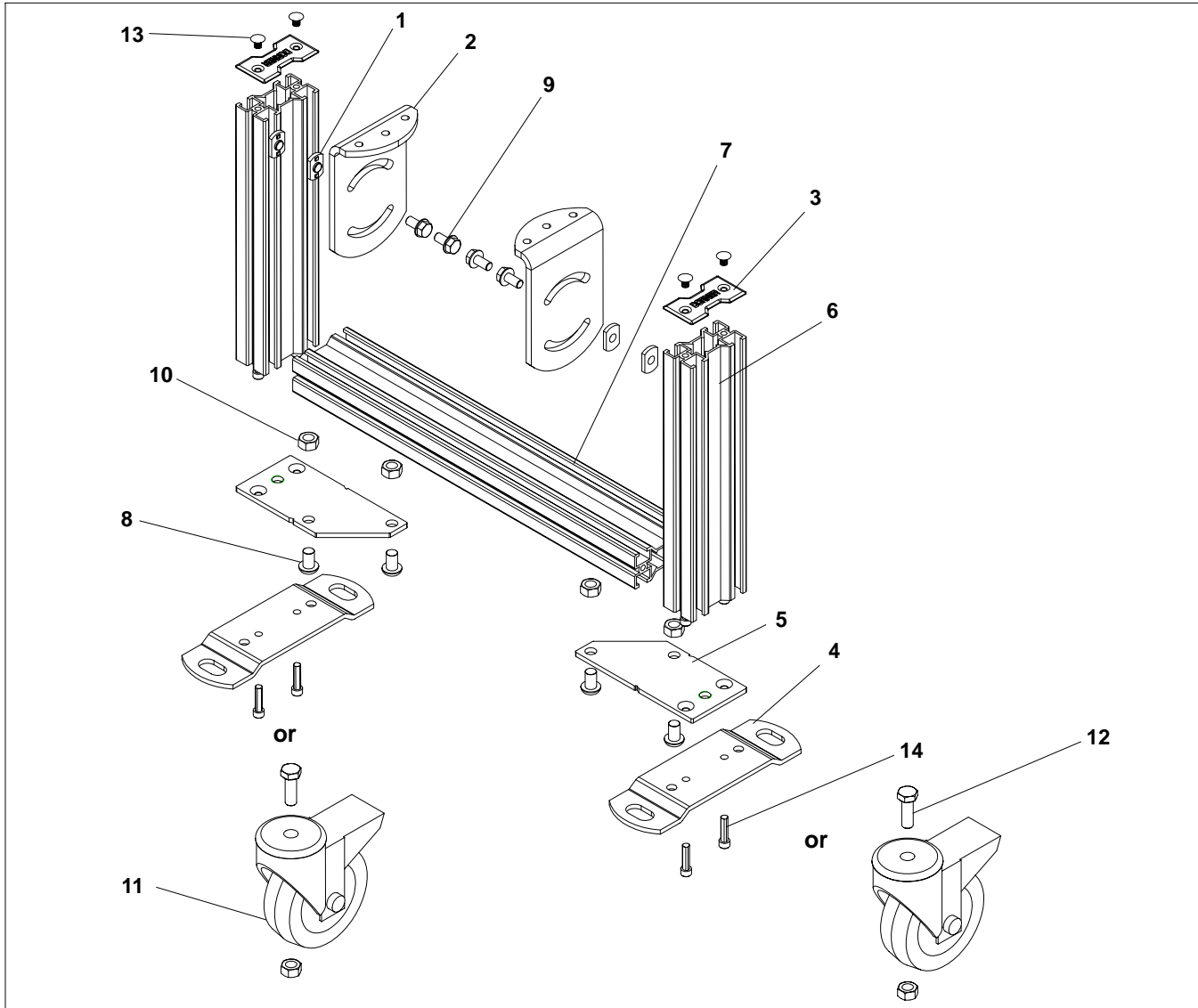

Item	Part Number	Description
1	807-1075	Nut, Weld M8XI .25-6H
2	200697	Ears, Mtg. 14" and over (2x)
	202148	Bracket, Mtg 12" and under (1x)
3	710003	Label-Cover, Stand
4	710004	Foot, Stand, Floor Mtg.
5	710007	Plate, Tie, Shortstand
6	See Leg Table	Leg, Stand Extrusion
7	See Cross-member Table	Crossmember, Extrusion

8	911016M	Scr, Btn, Metric M10-1.50x16MM
9	960883M	Scr, Hex Flange HD, M8x16MM
10	991001M	Nut, Hex, Full M10-1.50
11	807-640	Caster, 4"
12	961030	Scr, Cap, HD-Hex M10-1.50x30MM
13	807-1289	Rivet, Tree, .22 Dia x .75 Lg
14	708180P	Scr, Sock, Metric M6-1.00x25MM

<b>Item 6: Leg Stand Table</b>	
Leg Stand Height Range	Leg Stand Number
<b>Leg Stand w/Foot</b>	
6"-8" (152mm-203mm)	710211-00575
7"-9" (179mm-229mm)	710211-00675
8"-10" (203mm-254mm)	710211-00775
9"-11" (229mm-279mm)	710211-00875
10"-12" (254mm-305mm)	710211-00975
11"-13" (278mm-330mm)	710211-01075
12"-14" (305mm-356mm)	710211-01175
<b>Leg Stand w/Caster</b>	
11"-13" (279mm-330mm)	710211-00625
12"-14" (305mm-356mm)	710211-00725
13"-15" (330mm-381mm)	710211-00825
14"-16" (356mm-406mm)	710211-00925
15"-17" (381mm-432mm)	710211-01025
16"-18" (406mm-457mm)	710211-01125
17"-19" (432mm-483mm)	710211-01225

<b>Item 7: Crossmember Table</b>	
Stand Width	Crossmember Number
2"-12" (51mm-304mm)	710210-01075
14" (357mm)	710210-01275
16" (406mm)	710210-01475
18" (457mm)	710210-01675
20" (508mm)	710210-01875
22" (559mm)	710210-02075
24" (610mm)	710210-02275
26" (661mm)	710210-02475
28" (711mm)	710210-02675
30" (762mm)	710210-02875
32" (813mm)	710210-03075
34" (864mm)	710210-03275
36" (915mm)	710210-03475
38" (966mm)	710210-03675
40" (1016mm)	710210-03875
42" (1067mm)	710210-04075
44" (1118mm)	710210-04275
46" (1169mm)	710210-04475
48" (1220mm)	710210-04675

# Return Policy

Returns must have prior written factory authorization or they will not be accepted. Items that are returned to Dorner without authorization will not be credited nor returned to the original sender. When calling for authorization, please have the following information ready for the Dorner factory representative or your local distributor:

1. Name and address of customer.
2. Dorner part number(s) of Item(s) being returned.
3. Reason for return.
4. Customer's original order number used when ordering the item(s).
5. Dorner or distributor invoice number.

A representative will discuss action to be taken on the returned items and provide a Returned Goods Authorization number for reference.

There will be a return charge on all new undamaged items returned for credit where Dorner was not at fault. Dorner is not responsible for return freight on such items.

## **Conveyors and conveyor accessories**

Standard catalog conveyors	30%
MPB Series, cleated and specialty belt conveyors	50%
7400 & 7600 Series conveyors	non-returnable items
Engineered special products	case by case
Drives and accessories	30%
Sanitary stand supports	non-returnable items

## **Parts**

Standard stock parts	30%
MPB, cleated and specialty belts	non-returnable items

Returns will not be accepted after 60 days from original invoice date.

The return charge covers inspection, cleaning, disassembly, disposal and reissuing of components to inventory.

If a replacement is needed prior to evaluation of returned item, a purchase order must be issued. Credit (if any) is issued only after return and evaluation is complete.

Dorner has representatives throughout the world. Contact Dorner for the name of your local representative. Our Technical Sales, Catalog Sales and Service Teams will gladly help with your questions on Dorner products.

For a copy of Dorner's Warranty, contact factory, distributor, service center or visit our website at [www.dorner.com](http://www.dorner.com).

**For replacement parts, contact an authorized  
Dorner Service Center or the factory.**

# **DORNER**<sup>®</sup>

Dorner Mfg. Corp. reserves the right to change or discontinue products without notice. All products and services are covered in accordance with our standard warranty. All rights reserved. ©Dorner Mfg. Corp. 2000

## **DORNER MFG. CORP.**

975 Cottonwood Ave., PO Box 20  
Hartland, WI 53029-0020 USA

**USA**

**TEL 1-800-397-8664 (USA)**

**FAX 1-800-369-2440 (USA)**

**Internet: [www.dorner.com](http://www.dorner.com)**

**Outside the USA:**

**TEL 1-262-367-7600**

**FAX 1-262-367-5827**