

## Multi Tier Stands





## Table of Contents



WARNINGS – General Safety .....	2	Preventive Maintenance & Adjustment .....	7
Introduction .....	3	Required Tools .....	7
Product Description .....	3	Conveyor Height Adjustment .....	7
Specifications .....	3	Angle Adjustment .....	7
Installation .....	4	Bottom or Middle Tier Conveyor Service .....	8
Recommended Installation Sequence .....	4	Service Parts .....	10
Required Tools .....	4	Return Policy .....	12
Stand Assembly – Base Tier .....	4		
Stand Assembly – Upper Tier(s) .....	6		

# Warnings - General Safety

	<b>WARNING</b>	
<p>The safety alert symbol, black triangle with white exclamation, is used to alert you to potential personal injury hazards.</p>		



		<b>DANGER</b>
<p>Climbing, sitting, walking or riding on conveyor will cause severe injury. <b>KEEP OFF CONVEYORS.</b></p>		



		<b>DANGER</b>
<p><b>DO NOT OPERATE CONVEYORS IN AN EXPLOSIVE ENVIRONMENT.</b></p>		



		<b>WARNING</b>
<p>Insufficient clearance between conveyed product and upper conveyor support causes pinch points which can cause severe injury. <b>ALLOW A MINIMUM OF 2" (51mm) BETWEEN PRODUCT AND UPPER CONVEYOR MOUNTING.</b></p>		

		<b>WARNING</b>
<p>Exceeding maximum suggested height may cause instability of conveyors and stands. <b>DO NOT EXCEED 72" (1829mm) IN HEIGHT WITH MULTI TIER SUPPORT STANDS.</b></p>		

		<b>WARNING</b>
<p>Adding casters to Multi Tier Support Stands may cause instability of conveyors and stands. <b>DO NOT USE CASTERS WITH MULTI TIER STANDS.</b></p>		

		<b>WARNING</b>
<p>Exposed moving parts can cause severe injury. <b>LOCK OUT POWER</b> before removing guards or performing maintenance.</p>		

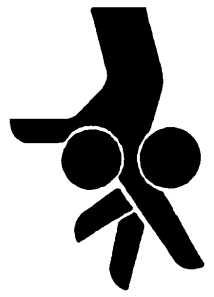
		<b>WARNING</b>
<p>Loosening stand height, angle adjustment, or tier tie bracket screws may cause conveyor sections to drop down, causing severe injury. <b>SUPPORT CONVEYOR SECTIONS PRIOR TO LOOSENING STAND HEIGHT OR ANGLE ADJUSTMENT SCREWS.</b></p>		

		<b>WARNING</b>
<p>Dorner cannot control the physical installation and application of conveyors. Taking protective measures is the responsibility of the user. When conveyors are used in conjunction with other equipment or as part of a multiple conveyor system, <b>CHECK FOR POTENTIAL PINCH POINTS</b> and other mechanical hazards before system start-up.</p>		

# Introduction

**IMPORTANT: Some illustrations may show guards removed. Do NOT operate equipment without guards.**

Upon receipt of shipment:

- Compare shipment with packing slip. Contact factory regarding discrepancies.

- Inspect packages for shipping damage. Contact carrier regarding damage.
- Accessories may be shipped loose. See accessory instructions for installation.

Dorner's Limited Warranty applies.

Dorner reserves the right to make changes at any time without notice or obligation.

## Product Description

Refer to Figure 1 for typical stand components.

Typical Components	
A	Tube End Covers
B	Tier Legs
C	Leg Support Brackets
D	Stand Legs
E	Base Assembly
F	Conveyor Mounting Brackets

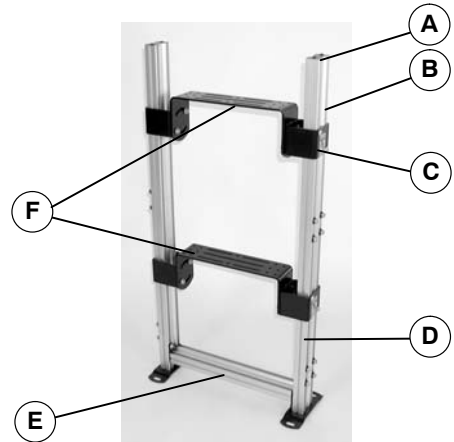
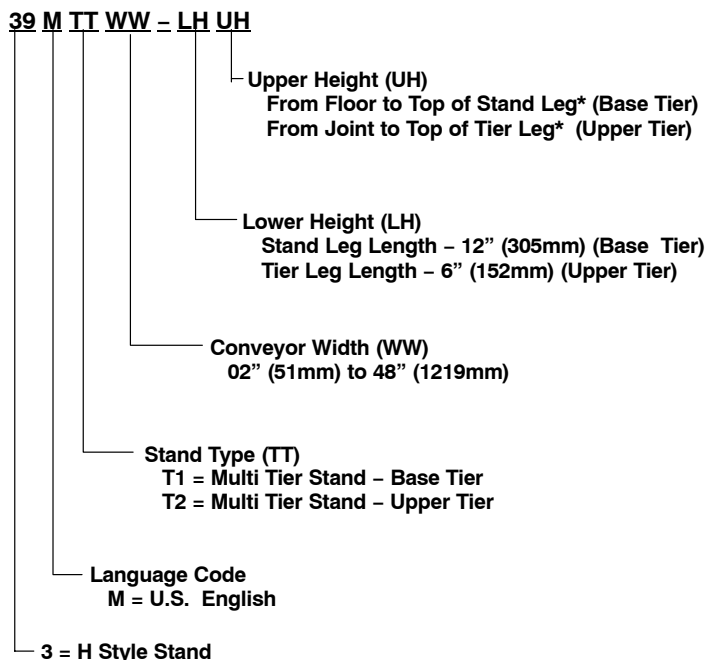

Figure 1

## Specifications

### Multi Tier Support Stand Models



Example: 39MT112-1260

Base Tier of Multi Tier, H style stand for a 12" (305mm) wide conveyor with a lower height of 12" (305mm) and an upper height of 60" (1524mm). The base tier comes partially assembled and has U.S. English documentation.

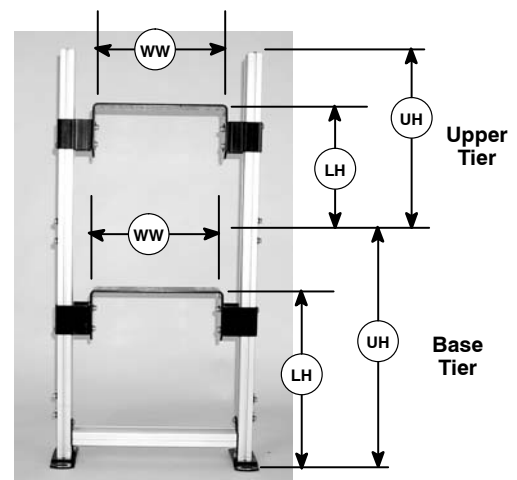

\* When raised to its maximum height, top of conveyor mounting bracket (F of Figure 1) is at the same height as top of stand leg (D) (base tier) or tier leg (B) (upper tier).

# Installation



**WARNING**  
Insufficient clearance between conveyed product and upper conveyor support causes pinch points which can cause severe injury.  
**ALLOW A MINIMUM OF 2" (51mm) BETWEEN PRODUCT AND UPPER CONVEYOR MOUNTING.**



**WARNING**  
Exposed moving parts can cause severe injury.  
**LOCK OUT POWER** before removing guards or performing maintenance.

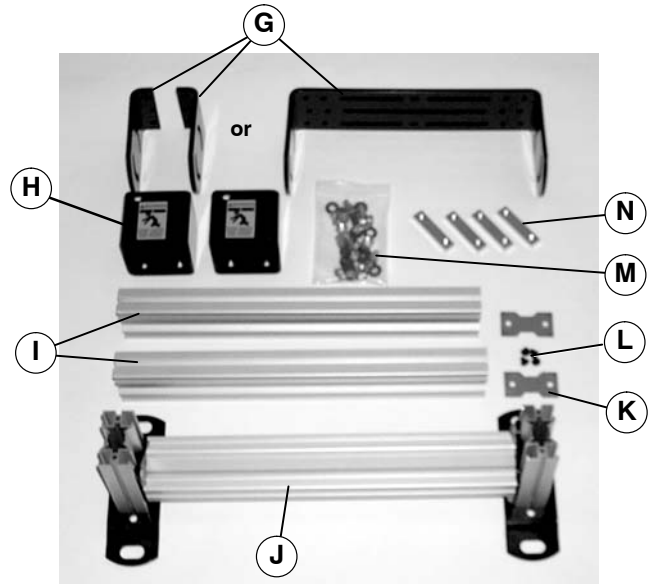

Figure 2

## Recommended Installation Sequence (see Table of Contents for page number)

- Assemble base tier
- Install bottom conveyor on base tier
- Assemble middle tier
- Attach middle tier to base tier
- Install middle conveyor
- Assemble top tier
- Attach top tier to middle tier
- Install top conveyor
- Adjust stand height and angle (see Preventative Maintenance and Adjustments section, page 7)

## Required Tools

- 6 mm Hex Key Wrench

## Stand Assembly – Base Tier

1. Typical components of multi tier stand (Figure 2).

Multi Tier Stand Typical Components (Figure 2)	
G	Stand/Conveyor Mounting Bracket(s)
H	Leg Support Brackets (2x)
I	Base Legs (2x)
J	Base Assembly (Base Tier, only)
K	Tube End Covers (2x)
L	Plastic Tree Rivets (4x)
M	Tier Hardware Pack
N	Tube Joining Bars (4x)

2. Open tier hardware pack (M of Figure 2). Install two hard washers (O of Figure 3) and M8 x 12mm socket head screws (P of Figure 3) on tube joining bar (N). Do not tighten screws.

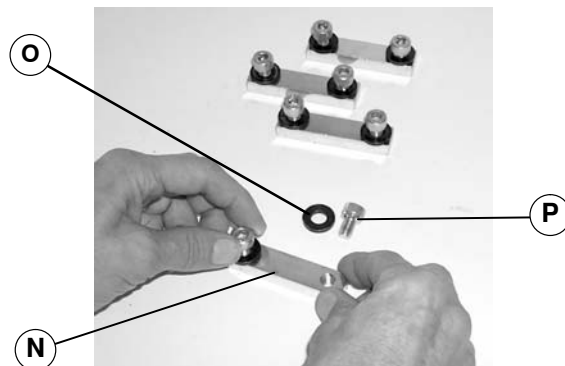



Figure 3

3. Repeat step 2 for three remaining tube joining bars.



**WARNING**  
Failure to secure tier joint screws (P of Figures 4 and 6) may cause tube joining bar and conveyor sections to drop down, causing severe injury.  
**TIGHTEN ALL TIER JOINT SCREWS (P) AFTER INSTALLATION.**

4. Install tube joining bar assembly (O of Figure 4) at top of leg on base assembly (J). Half of tube joining bar assembly must extend above leg, as shown. Tighten screw (P) to 130 in-lbs (15 Nm).

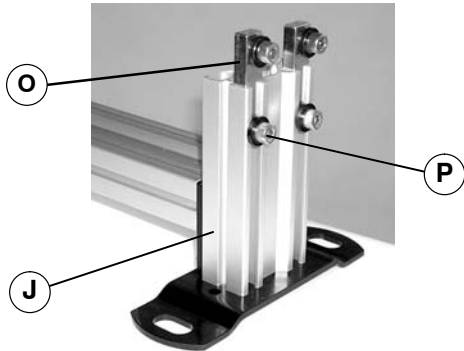

Figure 4

5. Repeat step 4 for three remaining tube joining bar assemblies.
6. Slide stand leg (I of Figure 5) over both tube joining bars (N) until it is resting on leg of base assembly (J).

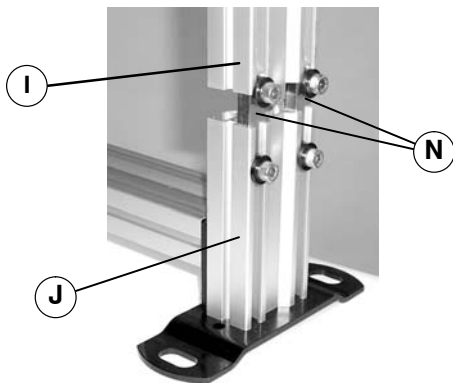

Figure 5

7. Tighten screws (P of Figure 6) to 130 in-lbs (15 Nm).

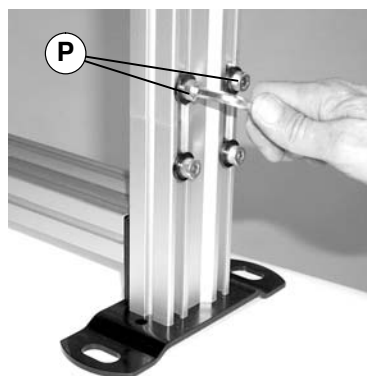

Figure 6

8. Repeat steps 6 and 7 for other stand leg.

**NOTE:** Leg support bracket (H of Figure 7) must be installed on stand/conveyor mounting bracket(s) (G) with warning label (Q) facing out. When installed, round end of stand/conveyor mounting bracket will be down and warning label will be upright, as shown.

9. Attach leg support bracket (H of Figure 7) to stand/conveyor mounting bracket (G) with two flange socket head screws (R). Do not tighten screws.

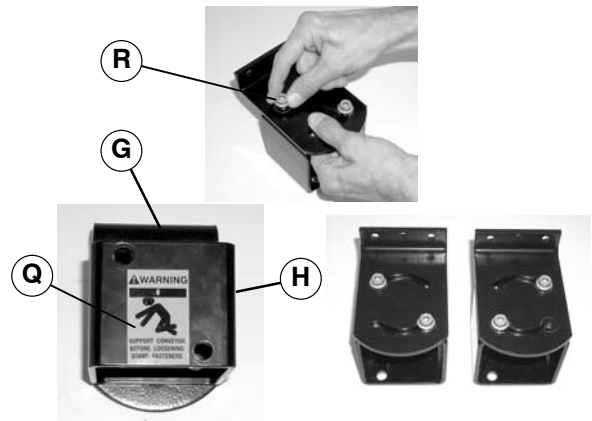

Figure 7

10. Repeat step 9 for opposite leg support bracket (H of Figure 7). To ensure proper attachment of stand/conveyor mounting bracket to conveyor, install flange socket head screws (R) in opposite holes on opposite leg support bracket, as shown.
11. Install two M10 x 16mm button head screws (S of Figure 8) and hex nuts (T) on leg support bracket (H). Do not tighten screws.

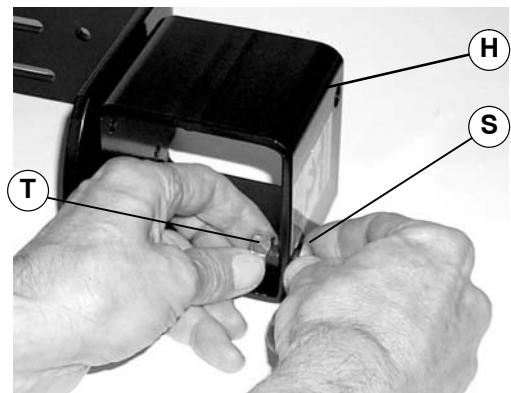

Figure 8

12. Repeat step 11 for other leg support bracket.

# Installation

13. Align two hex nuts (T of Figure 9) on each leg support bracket (H) to t-slots at top, outside of stand legs (I). Slide leg support brackets down stand legs until top of stand/conveyor mounting bracket (G) is approximately the same height as the bottom of conveyor. Tighten four button head screws (S) just enough to keep leg support brackets in position.

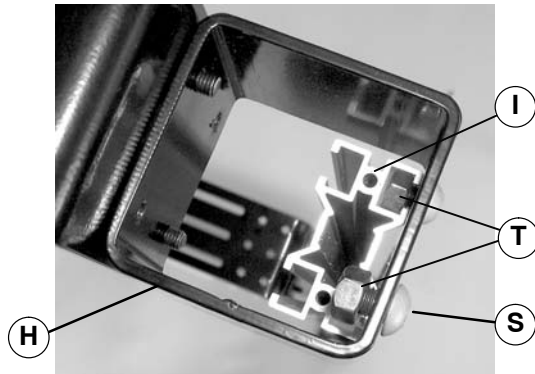

Figure 9

14. Install conveyor on base tier. See Conveyor Installation, Maintenance and Parts Manual for installation instructions.

	<p><b>WARNING</b></p> <p>Failure to secure screws (R and S of Figure 10) may cause conveyor section(s) to drop down causing severe injury.</p> <p><b>TIGHTEN SCREWS (R and S) AFTER ADJUSTMENT.</b></p>
--	---

15. Tighten four flange socket head screws (R of Figure 10) to 24 ft-lb (33 N-m).
16. Tighten four button head screws (S of Figure 10) to 17 ft-lb (22.5 N-m).

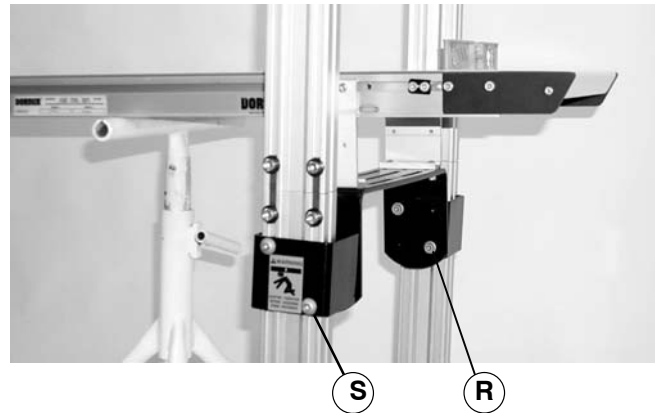

Figure 10

17. Make height and angle adjustments as required. See “Conveyor Height Adjustment” section on page 7. See “Angle Adjustment” section on page 7.

## Stand Assembly – Upper Tier(s)

1. For assembly of upper tier(s) on multi tier stand, repeat steps 2 through 17 for “Stand Assembly – Base Tier” starting on page 4.
2. Attach tube end cover (K of Figure 11) on stand leg (I) with two plastic tree rivets (L).

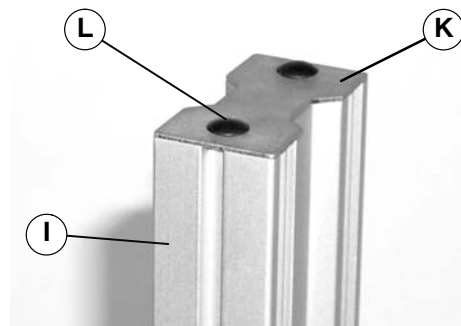

Figure 11

3. Repeat step 2 for opposite stand leg.

# Preventive Maintenance and Adjustment

## Required Tools

- 6 mm Hex Key Wrench
- Level

## Conveyor Height Adjustment

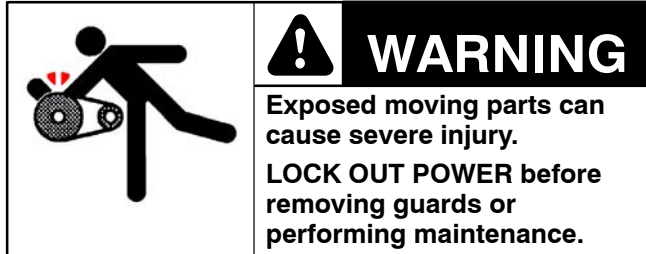

1. Install a support (U of Figure 12) below conveyor (V) that will be adjusted.

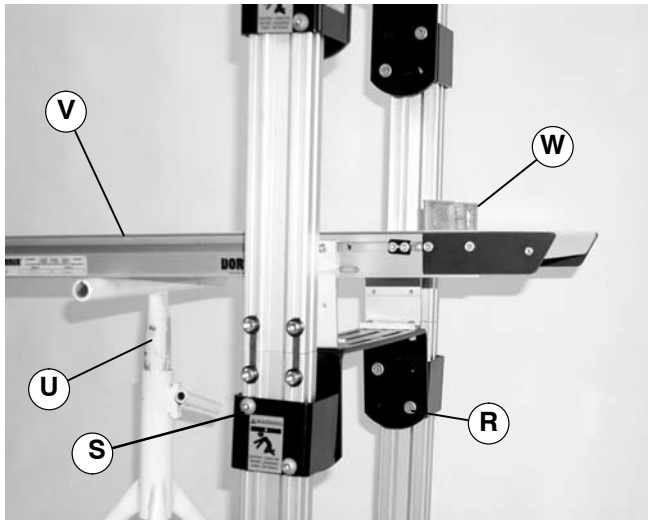

Figure 12



2. Loosen two flange socket head screws (R of Figure 12) on each side of conveyor (V).
3. Loosen two button head screws (S) on each side of conveyor (V).

4. Adjust conveyor to desired height. Using a level (W), ensure conveyor is level from side to side.



5. Tighten two flange socket head screws (R of Figure 12) on each side of conveyor (V) to 24 ft-lb (33 N-m).
6. Tighten two button head screws (S) on each side of conveyor (V) to 17 ft-lb (22.5 N-m).

## Angle Adjustment

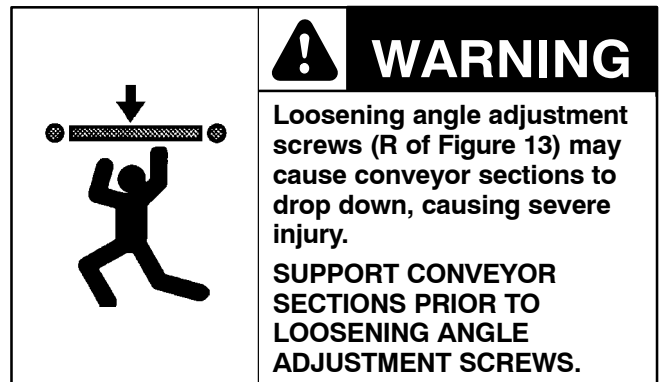

**NOTE:** To rotate conveyor mounting bracket (G of Figure 13), it may need necessary to relocated screws (R) to holes (X).

1. Loosen angle adjustment screws (R of Figure 13) on both sides of conveyor.

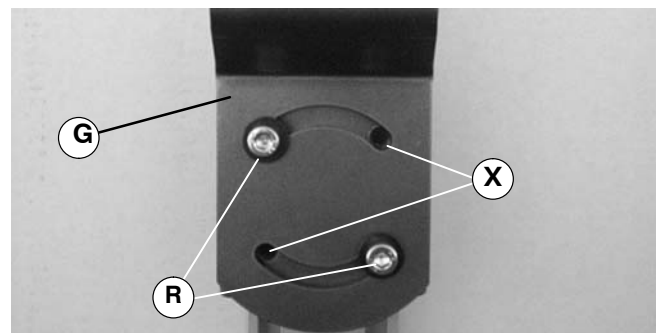
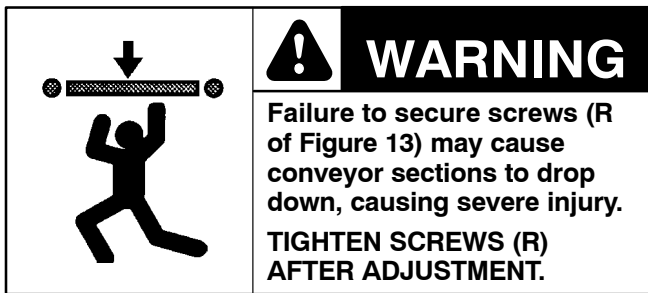

Figure 13



# Preventive Maintenance and Adjustment

- Adjust conveyor to desired angle. Using a level (W of Figure 12), ensure conveyor is level from side to side.



- Tighten angle adjustment screws (R) to 24 ft-lb (33 N-m).

## Bottom or Middle Tier Conveyor Service

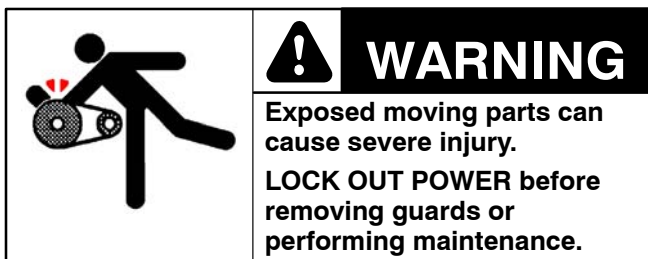

- Near the multi tier stand, support the conveyor to be serviced AND the conveyor directly above.
- Remove two flange socket head screws (R of Figure 14) from the conveyor to be serviced.

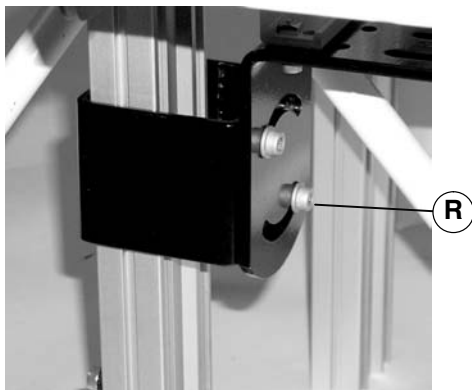

Figure 14

- Loosen eight screws (P of Figure 15).

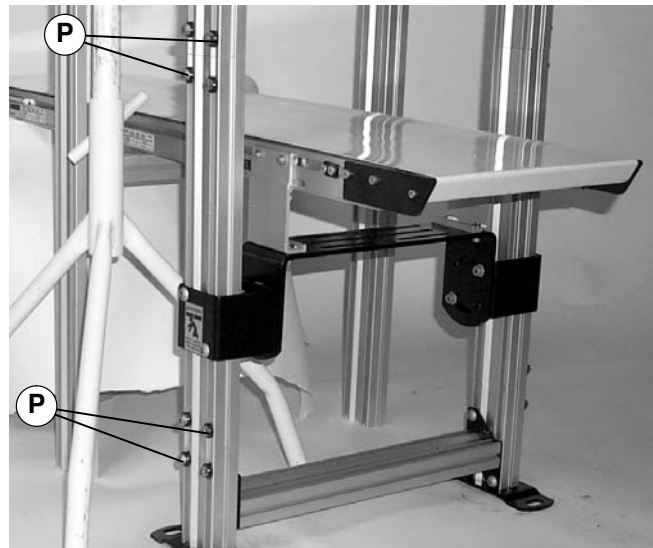

Figure 15

- Slide four tube joining bar assemblies (O of Figure 16) out of the way. Remove stand section (Y) and leg support bracket (H) from multi tier stand.

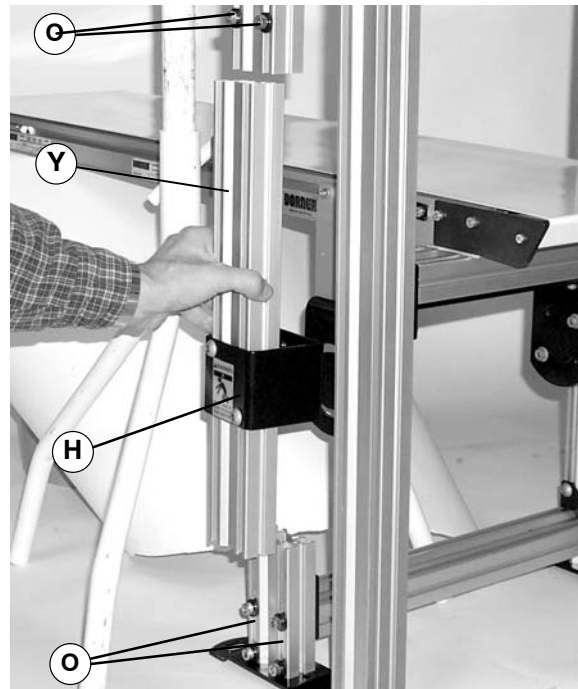

Figure 16

- Perform maintenance as required on conveyor.
- Reverse steps to reinstall stand section (Y) and leg support bracket (H) on multi tier stand when service is complete.
- Tighten eight screws (P of Figure 15) to 130 in-lbs (15 N-m) and two flange socket head screws (R of Figure 14) to 24 ft-lb (33 N-m).





# Service Parts

**NOTE: For replacement parts other than those shown on this page, contact an authorized Dorner Service Center or the factory.**

## Multi Tier Stand

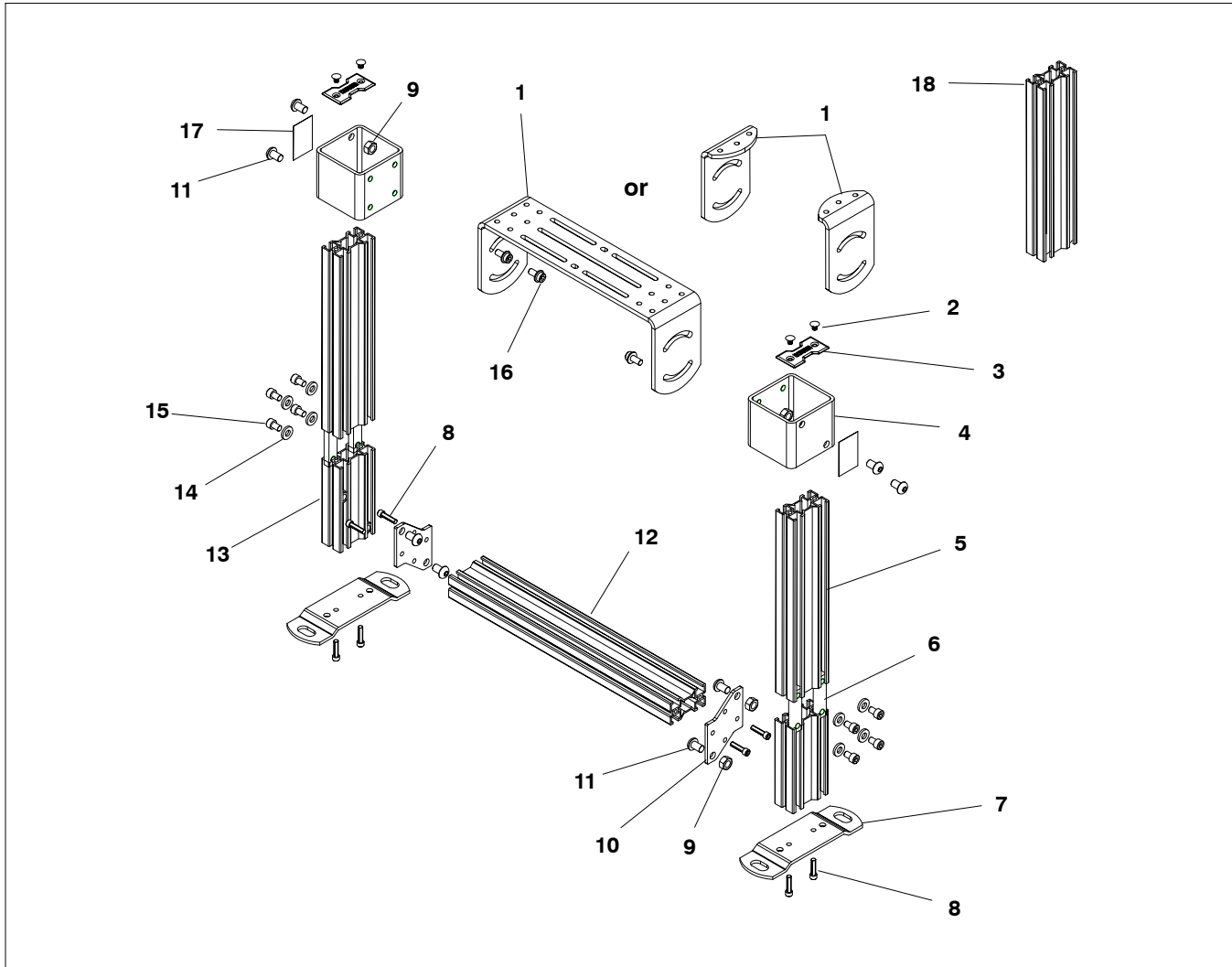

Item	Part Number	Description
1	202148	Brkt, Mtg., Conv 12" (305mm) Wide
	200697	Brkt, Mtg., Conv 14"-48" (356 - 1219mm) Wide (2x)
2	807-1289	Rivet, Tree, 0.22 Dia. x 0.75 Long
3	710003	Cover, Tube End, Stand
4	710016	Bracket, Leg Support
5	See Stand Leg Table	Leg, Multi Tier Stand
6	710041	Bar, Joining, Tubes
7	710004	Foot, Stand, Floor Mtg.
8	708180P	Scr, Sock, Metric M6-1.00x25MM

9	991001M	Nut, Hex, Full M10-1.50
10	710006	Plate, End, Crossmember
11	911016M	Scr, Btnn, Metric M10-1.50x16MM
12	See Cross-member Table	Crossmember
13	710213-00554	Leg, Base, Multi Tier Stand
14	605280P	Washer, Hard, .361X.750X.120
15	920812M	Scr, Sock, Metric M8-1.25x12MM
16	920883M	Scr, Flange, Socket M8-1.25x16MM
17	300324P	Label, Warning, Overhead Hazard
18	See Stand Tier Leg Table	Leg, Tier, Multi Tier Stand

# Service Parts

Item 5: Stand Leg	
Base Upper Height	Part Number
12" (305mm)	710211-00600
14" (356mm)	710211-00800
16" (406mm)	710211-01000
18" (457mm)	710211-01200
20" (508mm)	710211-01800
22" (559mm)	710211-02000
24" (610mm)	710211-02200
26" (660mm)	710211-02400
28" (711mm)	710211-02600
30" (762mm)	710211-02800
32" (813mm)	710211-03000
34" (864mm)	710211-03200
36" (914mm)	710211-03400
38" (965mm)	710211-03600
40" (1016mm)	710211-03800
42" (1067mm)	710211-04000
44" (1118mm)	710211-04200
46" (1168mm)	710211-04400
48" (1219mm)	710211-04600
50" (1270mm)	710211-04800
52" (1321mm)	710211-05000
54" (1372mm)	710211-05200
56" (1422mm)	710211-05400
58" (1473mm)	710211-05600
60" (1524mm)	710211-05800

Item 12: Crossmember	
Conveyor Width	Part Number
2-12" (51-305mm)	710210-01691
14" (356mm)	710210-01891
16" (406mm)	710210-02091
18" (457mm)	710210-02291
20" (508mm)	710210-02491
22" (559mm)	710210-02691
24" (610mm)	710210-02891
26" (660mm)	710210-03091

28" (711mm)	710210-03291
30" (762mm)	710210-03491
32" (813mm)	710210-03691
34" (864mm)	710210-03891
36" (914mm)	710210-04091
38" (965mm)	710210-04291
40" (1016mm)	710210-04491
42" (1067mm)	710210-04691
44" (1118mm)	710210-04891
46" (1168mm)	710210-05091
48" (1219mm)	710210-05291

Item 18: Tier Leg	
Tier Upper Height	Part Number
12" (305mm)	710211-01200
13" (330mm)	710211-01300
14" (356mm)	710211-01400
15" (381mm)	710211-01500
16" (406mm)	710211-01600
17" (432mm)	710211-01700
18" (457mm)	710211-01800
19" (483mm)	710211-01900
20" (508mm)	710211-02000
21" (533mm)	710211-02100
22" (559mm)	710211-02200
23" (584mm)	710211-02300
24" (610mm)	710211-02400
25" (635mm)	710211-02500
26" (660mm)	710211-02600
27" (686mm)	710211-02700
28" (711mm)	710211-02800
29" (737mm)	710211-02900
30" (762mm)	710211-03000
31" (787mm)	710211-03100
32" (813mm)	710211-03200
33" (838mm)	710211-03300
34" (864mm)	710211-03400
35" (889mm)	710211-03500
36" (914mm)	710211-03600

---

## Return Policy

---

No returns will be accepted without prior written factory authorization. When calling for authorization, please have the following information ready for the Dorner Factory representative or your local distributor:

1. Name and address of customer.
2. Item(s) being returned.
3. Reason for return.
4. Customer's original order number used when ordering the item(s).
5. Dorner or distributor invoice number.

A representative will discuss action to be taken on the Returned items and provide a Returned Goods Authorization Number to reference.

There will be a 15% restocking charge on all new items returned for credit where Dorner was not at fault. These will not be accepted after 60 days from original invoice date. The restocking charge covers inspection, cleaning, disassembly, and reissuing to inventory.

If a replacement is needed prior to evaluation of returned item, a purchase order must be issued. Credit (if any) is issued only after return and evaluation is complete.

Dorner has representatives throughout the world. Feel free to contact Dorner for the name of your local representative. Our technical sales and service staff will gladly help with your questions on Dorner products.

For a copy of Dorner's Limited Warranty, contact factory, distributor, service center or visit our website @ [www.dorner.com](http://www.dorner.com)

**For replacement parts, contact an authorized  
Dorner Service Center or the factory.**

**DORNER<sup>®</sup>**

Dorner Mfg. Corp. reserves the right to change or discontinue products without notice. All products and services are covered in accordance with our standard warranty. All rights reserved. ©Dorner Mfg. Corp. 1999

**DORNER MFG. CORP.**

975 Cottonwood Drive, PO Box 20  
Hartland, WI 53029-0020 USA

**USA**

**TEL 1-800-397-8664 (USA)**

**FAX 1-800-369-2440 (USA)**

**Internet: [www.dorner.com](http://www.dorner.com)**

**Outside the USA:**

**TEL 1-262-367-7600**

**FAX 1-262-367-5827**