

7200/7300 Series Top Mount Drive Package for Heavy Load 90° Sanitary Gearmotors

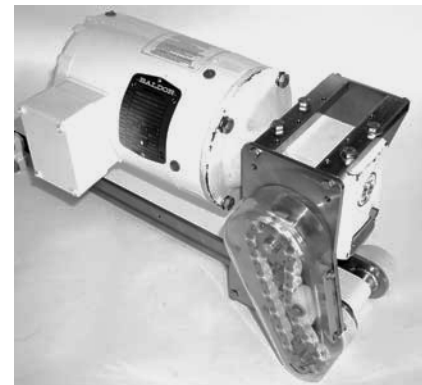
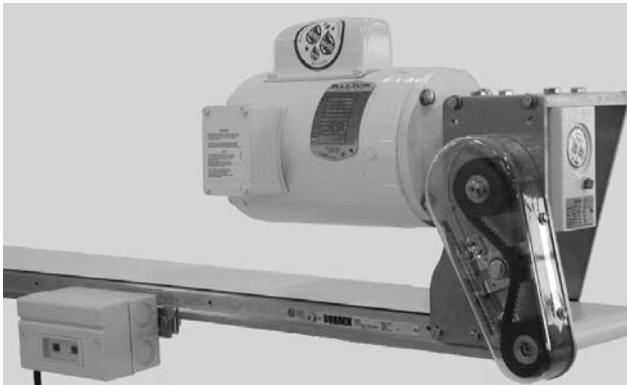

Table of Contents

Warnings – General Safety	2	Motor Starter Mounting	10
Introduction	2	Wiring	11
Product Description	3	Single-phase Motor Starter	11
Specifications	3	Three-phase Motor Starter	11
Installation	5	VFD Controller	11
Required Tools	5	Preventive Maintenance & Adjustment	12
Recommended Installation Sequence	5	Required Tools	12
Top Mount Assembly Installation	5	Timing Belt or Chain Replacement	12
A – 7200 Series Top Mount Assembly		A – Timing Belt Replacement	12
Installation	6	B – Timing Chain Replacement	13
B – 7300 Series Top Mount Assembly		Timing Belt or Chain Tensioning	14
Installation	6	Gear Reducer Replacement	15
Timing Belt or Chain Installation	6	Motor Replacement	16
A – Timing Belt Installation	6	Service Parts	18
B – Timing Chain Installation	8	7200/7300 Series Drive Mounting Components	18
Motor Installation	9	Return Policy	22

Warnings – General Safety

	WARNING	
<p>The safety alert symbol, black triangle with white exclamation, is used to alert you to potential personal injury hazards.</p>		

	WARNING
<p>Gearmotors may be HOT. DO NOT TOUCH Gearmotors.</p>	

	DANGER
<p>Climbing, sitting, walking or riding on conveyor will cause severe injury. KEEP OFF CONVEYORS.</p>	

	WARNING
<p>Exposed moving parts can cause severe injury. LOCK OUT POWER before removing guards or performing maintenance.</p>	

	DANGER
<p>Do NOT OPERATE CONVEYORS IN AN EXPLOSIVE ENVIRONMENT.</p>	

	WARNING
<p>Dorner cannot control the physical installation and application of conveyors. Taking protective measures is the responsibility of the user.</p> <p>When conveyors are used in conjunction with other equipment or as part of a multiple conveyor system, CHECK FOR POTENTIAL PINCH POINTS and other mechanical hazards before system start-up.</p>	

	DANGER
<p>Hazardous voltage will cause severe injury or death. LOCKOUT POWER BEFORE WIRING.</p>	

Introduction

IMPORTANT: Some illustrations may show guards removed. Do NOT operate equipment without guards.

Upon receipt of shipment:

- Compare shipment with packing slip. Contact factory regarding discrepancies.
- Inspect packages for shipping damage. Contact carrier regarding damage.
- Accessories may be shipped loose. See accessory instructions for installation.

Dorner's Limited Warranty applies.

Dorner has convenient, pre-configured kits of Key Service Parts for all conveyor products. These time saving kits are easy to order, designed for fast installation, and guarantee you will have what you need when you need it. Key Parts and Kits are marked in the Service Parts section of this manual with the Performance Parts Kits logo

Dorner 7200 and 7300 Series conveyors are covered by patent number 5174435, 6109427 and corresponding patents and patent applications in other countries.

Dorner reserves the right to make changes at any time without notice or obligation.

Product Description

Refer to Figure 1 for typical components.

Typical Components	
A	Conveyor
B	Top Mount Assembly
C	Motor
D	Timing Belt Tensioner
E	Cover
F	Timing Belt
G	Drive Pulley
H	Driven Pulley
I	Motor Control

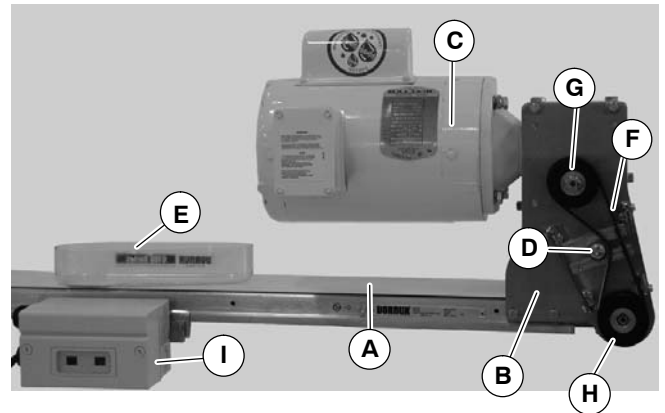

Figure 1

Specifications

Drive Mounting Package Models:

Example:

72 M T L Z WW A = 1932

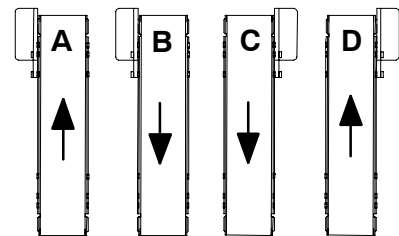
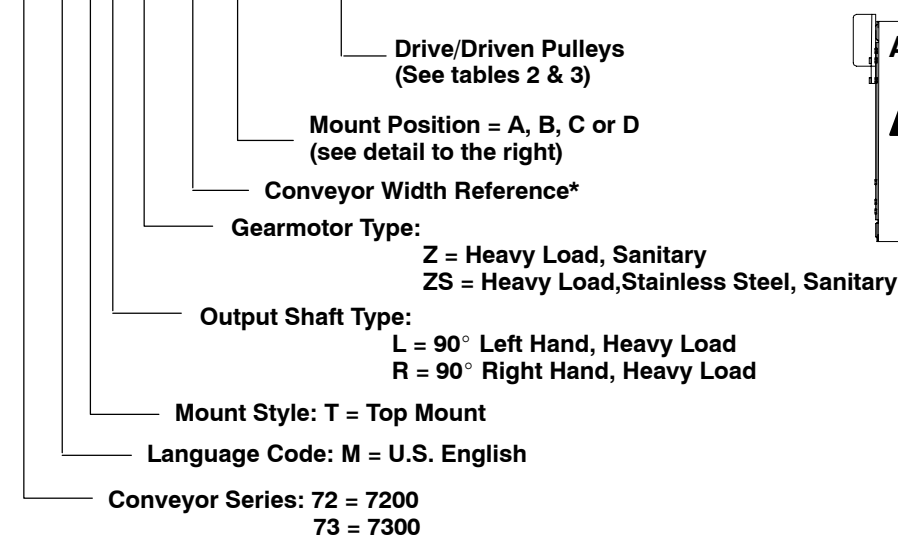

* See "Ordering and Specifications" Catalog for details.

Table 1: Gearmotor Specifications

	Single-Phase	Three-Phase	VFD Variable Speed	DC Variable Speed
Output Power	0.5 hp (0.37 kw)			.33 hp (0.25 kw)
Input Voltage	115 Volts A.C.	208-230/460 Volts A.C.	230 Volts A.C.	90 Volts D.C.
Input Frequency	60 Hz	60 Hz	10 to 60 Hz	N/A
Full Load Amperes	6.8 Amperes	1.8 - 1.6/.8 Amperes	1.6 Amperes	3.2 Amperes
Gearmotor Ratios	5:1, 15:1 and 50:1			
Protection Ratings	IP55 for Gearmotor and Motor Starter			

Specifications

Table 2: Heavy Load Fixed Speed 90° Sanitary 60 Hz Gearmotors

Gearmotor				Conveyor Belt Speed		Belt Drive		Chain Drive	
Gear Ratio	RPM	In-lb	N-m	ft/min	M/min	Drive Pulley	Driven Pulley	Drive Sprocket	Driven Sprocket
50:1	35	380	42.9	7	2.1	19	32	-	-
50:1	35	380	42.9	14	4.3	-	-	12	10
50:1	35	380	42.9	17	5.2	44	32	-	-
50:1	35	380	42.9	24	7.3	-	-	20	10
15:1	115	146	16.5	35	10.7	28	32	-	-
15:1	115	146	16.5	49	14.9	-	-	12	10
15:1	115	146	16.5	56	17.1	44	32	-	-
15:1	115	146	16.5	73	22.3	-	-	18	10
15:1	115	146	16.5	81	24.7	44	22	-	-
5:1	345	55	6.2	106	32.3	28	32	-	-
5:1	345	55	6.2	145	44.2	-	-	12	10
5:1	345	55	6.2	167	50.9	44	32	-	-
5:1	345	55	6.2	190	57.9	44	28	-	-
5:1	345	55	6.2	264	80.5	48	22	-	-

Table 3: Heavy Load Variable Speed 90° Sanitary VFD and DC Gearmotors

Gearmotor				Conveyor Belt Speed		Belt Drive		Chain Drive	
Gear Ratio	RPM	In-lb*	N-m*	ft/min	M/min	Drive Pulley	Driven Pulley	Drive Sprocket	Driven Sprocket
50:1	35	380	42.9	1.2 – 7	0.4 – 2.1	19	32	-	-
50:1	35	380	42.9	2.3 – 14	0.7 – 4.3	-	-	12	10
50:1	35	380	42.9	2.8 – 17	0.9 – 5.2	44	32	-	-
50:1	35	380	42.9	4.0 – 24	1.2 – 7.3	-	-	20	10
15:1	115	146	16.5	5.8 – 35	1.8 – 10.7	28	32	-	-
15:1	115	146	16.5	8.2 – 49	2.5 – 14.9	-	-	12	10
15:1	115	146	16.5	9.3 – 56	2.8 – 17.1	44	32	-	-
15:1	115	146	16.5	12.2 – 73	3.7 – 22.3	-	-	18	10
15:1	115	146	16.5	13.5 – 81	4.1 – 24.7	44	22	-	-
5:1	345	55	6.2	17.7 – 106	5.4 – 32.3	28	32	-	-
5:1	345	55	6.2	24.2 – 145	7.4 – 44.2	-	-	12	10
5:1	345	55	6.2	27.8 – 167	8.5 – 50.9	44	32	-	-
5:1	345	55	6.2	31.7 – 190	9.7 – 57.9	44	28	-	-
5:1	345	55	6.2	44 – 264	13.4 – 80.5	48	22	-	-

* At 60 Hz (AC motors)

NOTE: For belt speed other than those listed, contact factory for details.

Required Tools

- Wrenches (for hexagon head fasteners)
7mm, 8mm, 10mm, 9/16"
- 2.5 mm hex key wrench
- Straight edge
- Torque wrench

Recommended Installation Sequence

- Install top mount assembly on conveyor
- Attach support stand to top mount assembly (see accessory instructions)
- Attach other support stand(s) to conveyor (see accessory instructions)
- Install timing belt or timing chain
- Install motor
- Mount motor starter
- Wire motor starter

NOTE: 7200 Series drive mounting package with a timing chain shown. 7300 Series and timing belt drive mounting packages are similar.

Typical Drive Mounting Package Components

J	Top Mount Assembly
K	Hexagon Head Cap Screws (4x)
L	Timing Chain or Timing Belt
M	Driven Sprocket or Pulley
N	Drive Cover
O	Motor Key, 3/16" Square
P	Motor Mounting Screws & Washers (4x)
Q	Drive Sprocket or Pulley
R	Motor
S	Gear Reducer
T	Motor Starter
U	M6 x 20mm Hex Head Screws (2x)
V	Accessory Mounting Clips
W	Key, 4mm Square
X	Anti-seize Compound

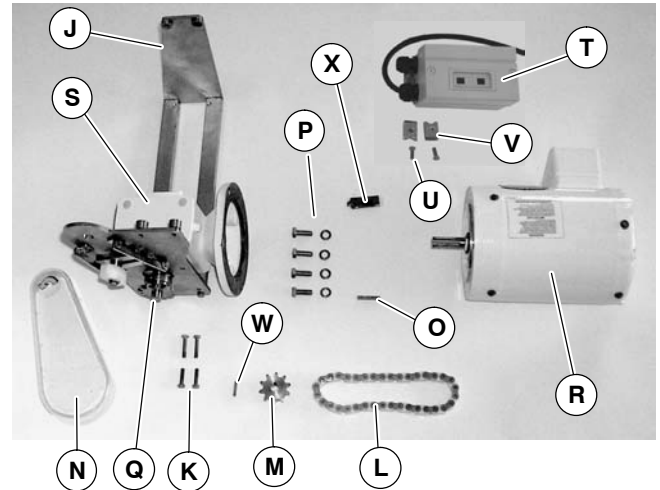
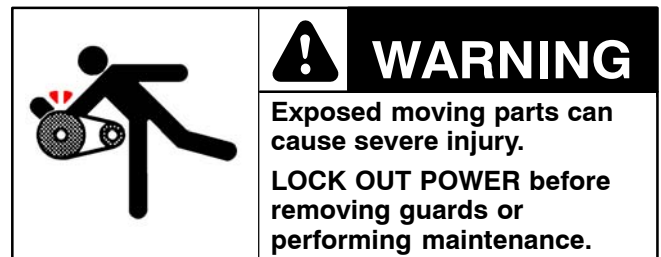

Figure 2

Top Mount Assembly Installation



1. Remove screws (Y of Figure 3) from both sides of conveyor.

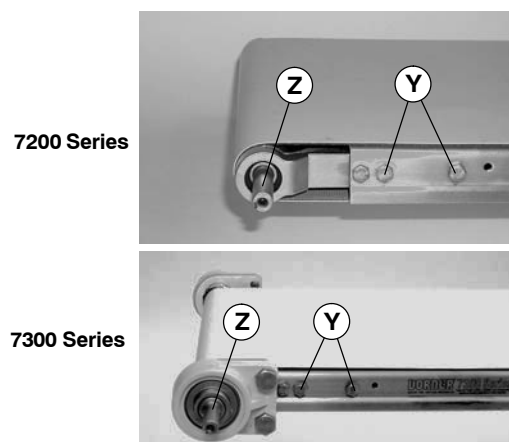

Figure 3

- A – 7200 Series Top Mount Assembly Installation.
- B – 7300 Series Top Mount Assembly Installation.

Installation

A – 7200 Series Top Mount Assembly Installation

NOTE: 7200 Series 4" (102mm) and wider mounting assembly shown. 2" (51mm) and 3" (76mm) wide mounting assemblies include two spacer tubes (AB of Figure 5) and two long M6 screws (AC).

- 2a. For 4" (102mm) and wider conveyors, loosen two screws (AA of Figure 4). Attach top mount assembly (J) to conveyor with two screws (K) on each side of conveyor. Tighten all screws to 92 in-lb (10.4 Nm).

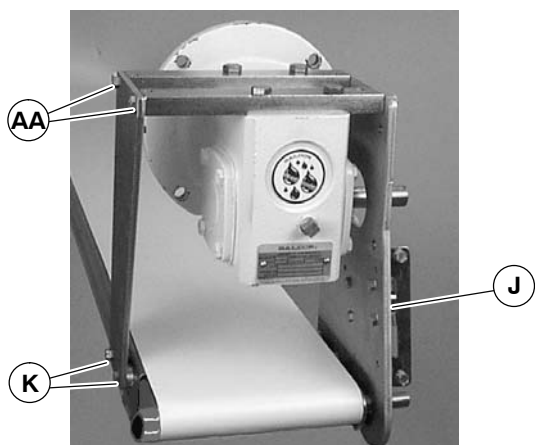

Figure 4

- 2b. For 2" (51mm) and 3" (76mm) conveyors, loosen two screws (AA of Figure 5) on each side of top mount assembly (J). Attach top mount assembly to conveyor with two spacer tubes (AB) and screws (AC), and two screws (K). Tighten all screws to 92 in-lb (10.4 Nm).

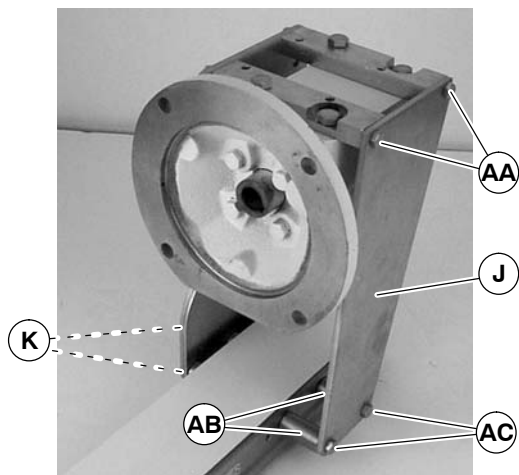

Figure 5

B – 7300 Series Top Mount Assembly Installation

NOTE: 7300 Series 2" (51mm) wide top mount assembly shown. Installation of 3" (76mm) and 4" (102mm) and wider top mount assemblies are similar.

The lengths of spacer tubes (AF of Figure 6) and hex head cap screws (AG) are based on conveyor width. The proper lengths are provided with the drive mounting package.

3. Loosen two screws (AA) on each side of top mount assembly (J). Attach top mount assembly to conveyor with two 1.758" (44.7mm) long spacer tubes (AD) and M6 x 65mm hex head cap screws (AE), and two spacer tubes (AF) and screws (AG). Tighten all screws to 92 in-lb (10.4 Nm).

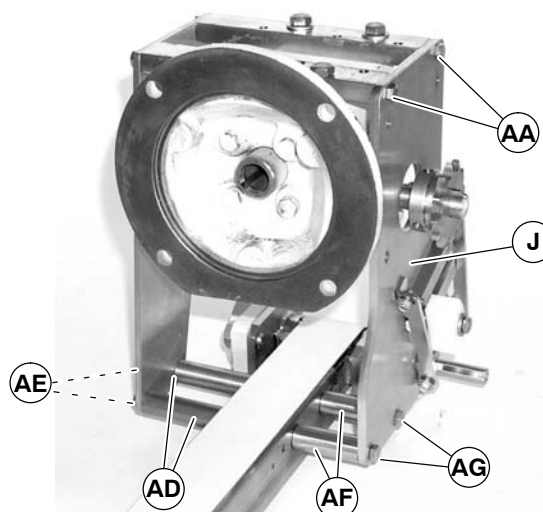
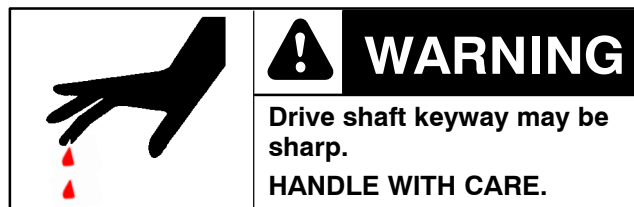

Figure 6

Timing Belt or Chain Installation

- A – Timing Belt Installation.
- B – Timing Chain Installation.

A – Timing Belt Installation



Installation

1. Install key (W of Figure 7) into conveyor input shaft (Z).

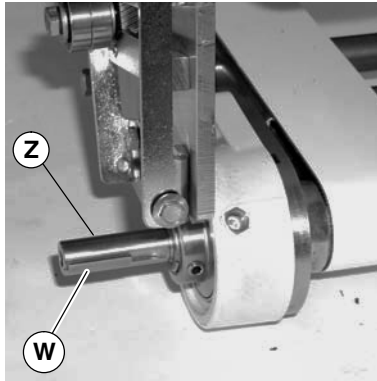

Figure 7

2. Depending on conveyor belt travel (direction 1 or 2 of Figure 8), locate timing belt tensioner (AH), as shown. Do not tighten tensioner screw.

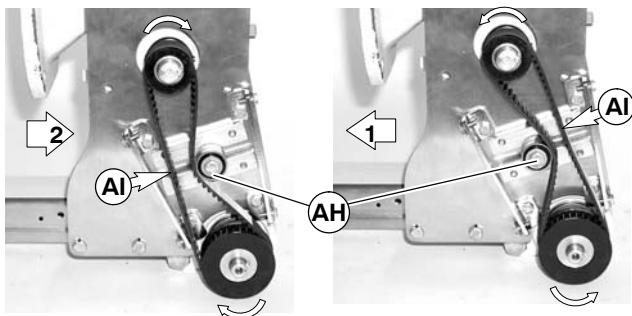

Figure 8

3. Wrap timing belt (L of Figure 9) around driven pulley (M) and drive pulley (Q). Slide driven pulley onto conveyor shaft.

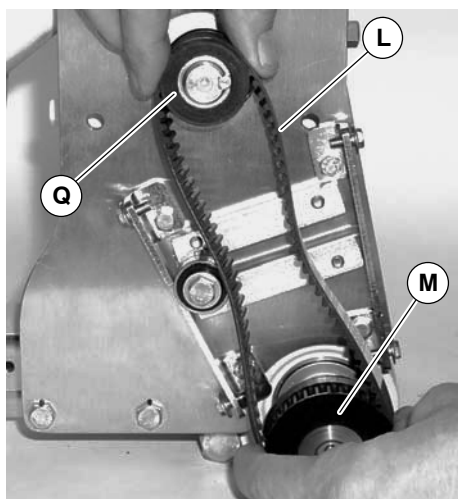

Figure 9

4. Using a straight edge (AJ of Figure 10), align driven pulley (M) with drive pulley (Q). Tighten two driven pulley set screws (AK).

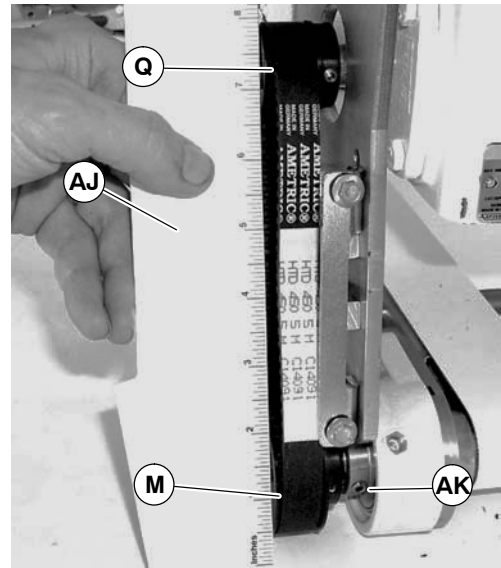

Figure 10

5. Tension timing belt to obtain 1/8" (3 mm) deflection for 1 lb (4.3 N) of force at timing belt mid-point (AI of Figure 8). Tighten tensioner screw to 38 ft-lb (51 Nm).

NOTE: Do not over-tighten screws (AL of Figure 11).

6. Attach cover (N) with four screws (AL). Tighten screws to 35 in-lb (4 Nm).

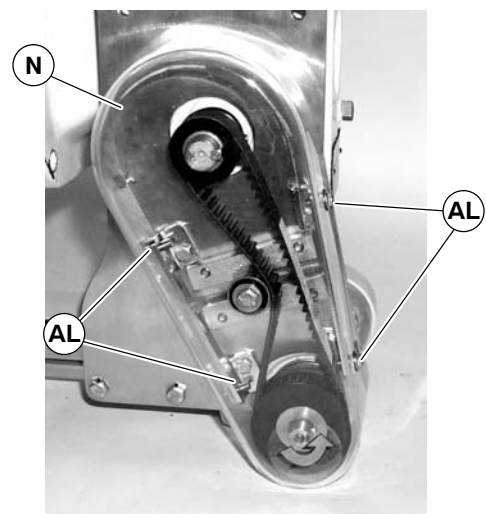

Figure 11

Installation

B – Timing Chain Installation



1. Install key (W of Figure 12) into conveyor input shaft (Z).

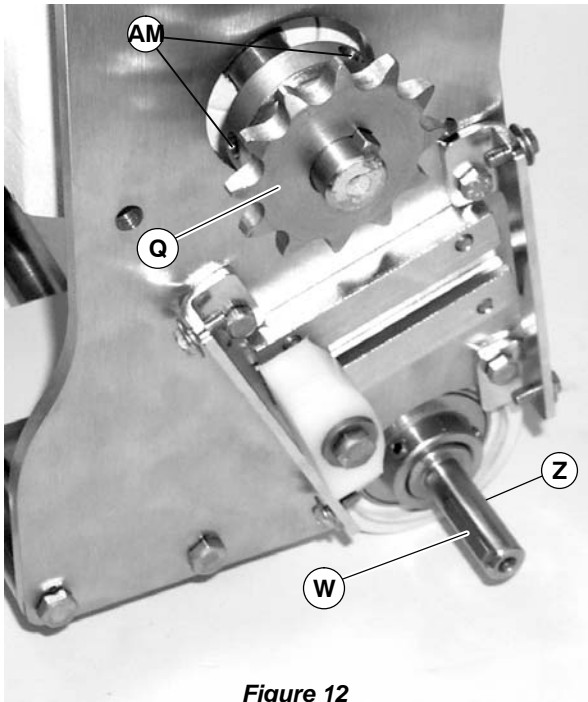

Figure 12

NOTE: Depending on sprocket sizes, it may be necessary to remove drive sprocket (Q of Figure 12) by loosening two set screws (AM) to install chain and sprockets.

2. Depending on conveyor belt travel (direction 1 or 2 of Figure 13), locate timing chain tensioner (AN) as shown. Do not tighten tensioner screw.

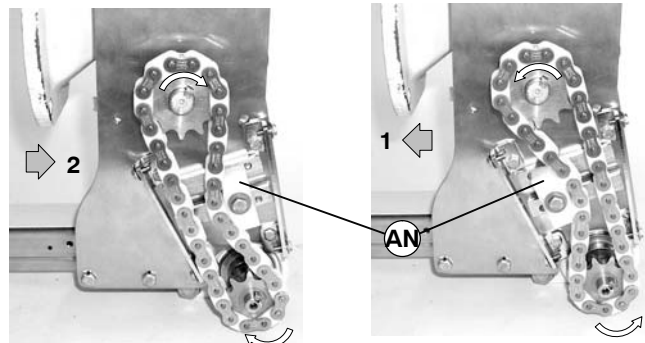

Figure 13

3. Install timing chain (L of Figure 14) over sprockets (M and Q). Install timing chain and sprockets on conveyor input shaft (Z) and gear reducer output shaft (AO). Do not tighten sprocket set screws.

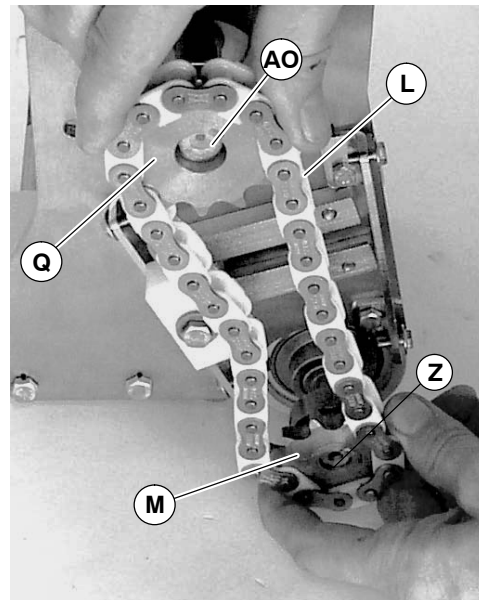

Figure 14

IMPORTANT: Make sure center of timing chain (L of Figure 15) aligns with center of chain tensioner (AN). If necessary, loosen two set screws (AM) to move drive sprocket (Q) in or out. Tighten set screws. Also, if necessary, loosen two set screws (AP) to move driven sprocket (M) in or out. Tighten set screws.

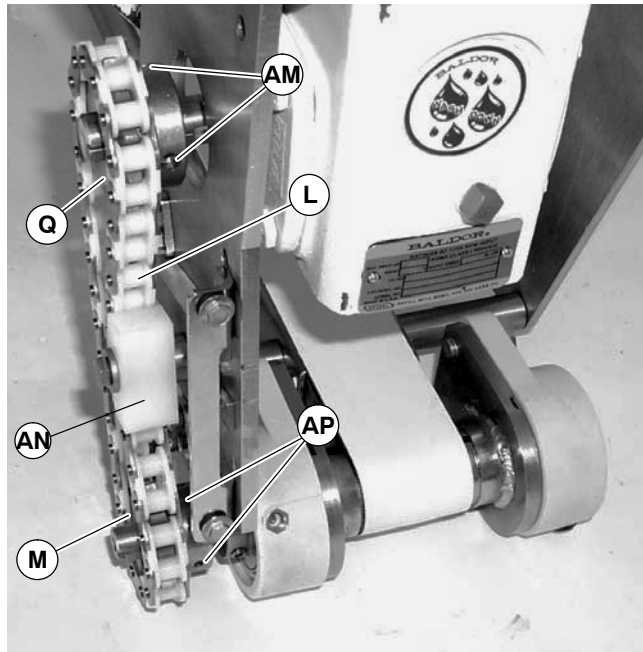

Figure 15

NOTE: Do not over-tension timing chain (L). Only tension chain until slack is removed.

4. Slide chain tensioner (AN) to take up chain slack. Tighten chain tensioner screw to 92 in-lb (10.4 Nm).

NOTE: Do not over-tighten screws (AL of Figure 16).

5. Install cover (N of Figure 16) and tighten four screws (AL) to 35 in-lb (4 Nm).

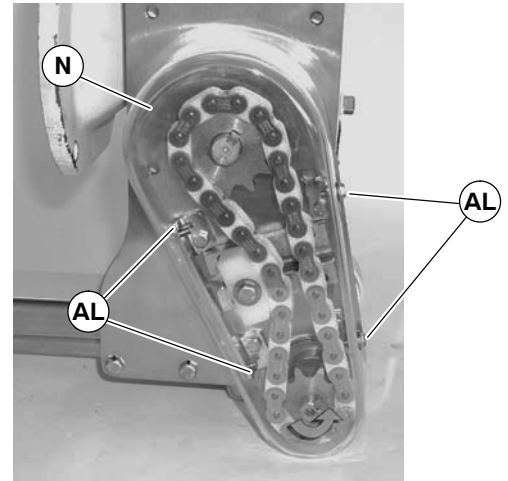

Figure 16

Motor Installation

		WARNING
	Drive shaft keyway may be sharp. HANDLE WITH CARE.	

1. Install key (O of Figure 17).

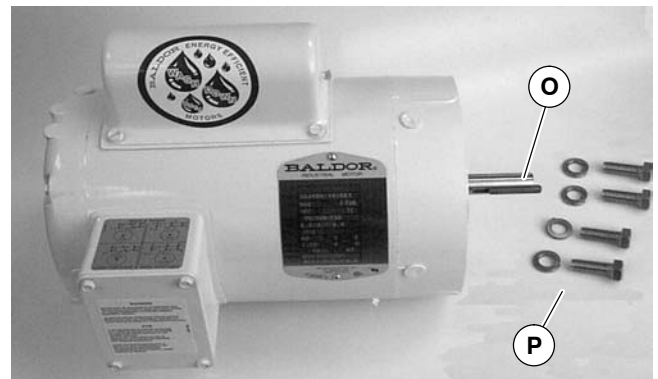

Figure 17

Installation

2. Apply anti-seize compound (X of Figure 18) to motor shaft.

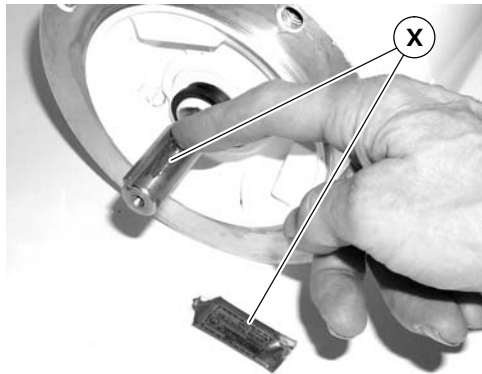

Figure 18

IMPORTANT: Be extremely careful when coupling motor (R of Figure 19) to gear reducer (S). Avoid misalignment and forcing the connection causing possible permanent gear reducer seal damage.

3. Attach motor (R) to gear reducer (S) with four screws and lock washers (P). Tighten screws to 32 ft-lb (41 Nm).

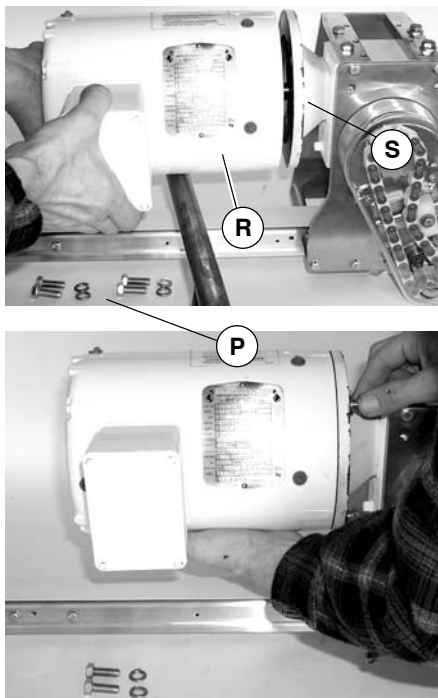

Figure 19

Motor Starter Mounting

NOTE: Single-phase Motor Starter shown, Three-phase Starter similar. For VFD controller mounting, see accessory instructions.

1. Attach two accessory mounting clips (V of Figure 20) to motor starter (T) with two M6 x 20mm hex head cap screws (U). Do not tighten screws.

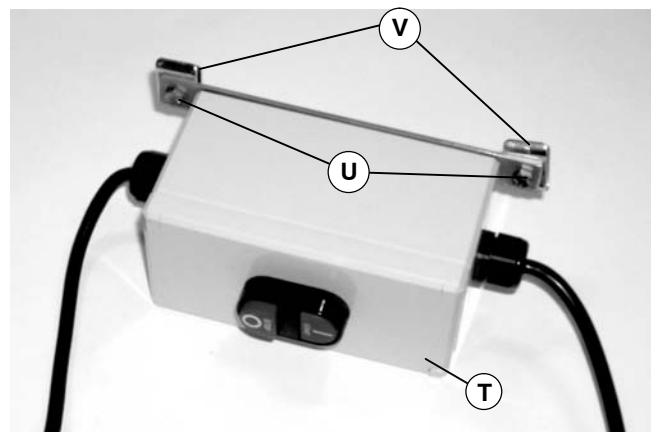

Figure 20

2. Attach motor starter (T of Figure 21) with clips to conveyor. Tighten screws (U) to 92 in-lb (10.4 Nm).

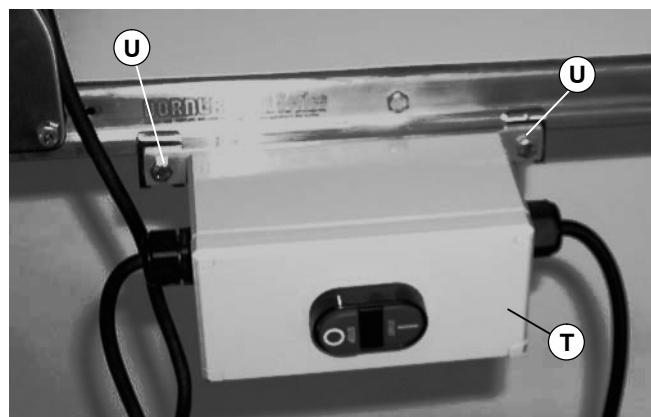

Figure 21

Wiring

Single-phase Motor Starter

NOTE: Power cord must be plugged into a GFI outlet. No additional wiring is required.

Three-phase Motor Starter

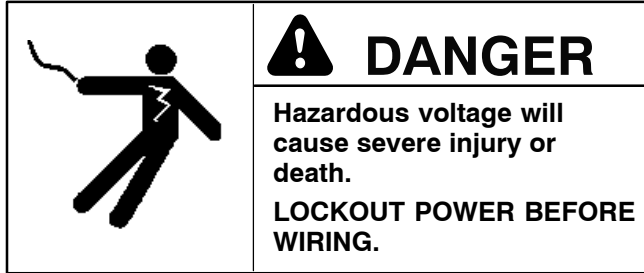

NOTE: 230 volt three-phase manual motor starters must be wired in accordance with applicable electrical codes.

1. Loosen cover screws (AQ of Figure 22). Remove cover.

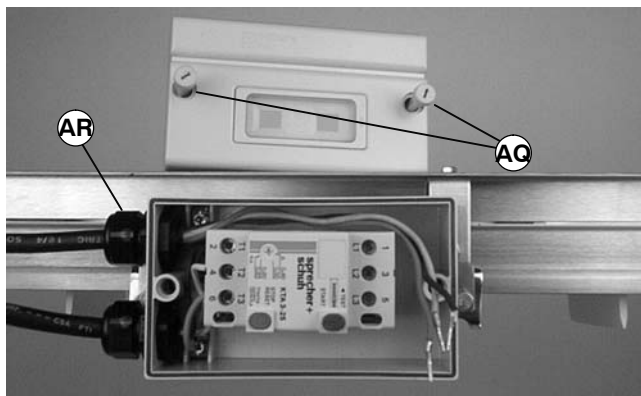

Figure 22

NOTE: Line cord must be 0.28" (7 mm) minimum to 0.47" (12 mm) maximum in diameter.

2. Insert line cord through grip (AR) and tighten nut.

3. For correct three-phase motor shaft rotation, connect line phase sequence L1, L2 & L3 to terminals as shown (Figure 23).

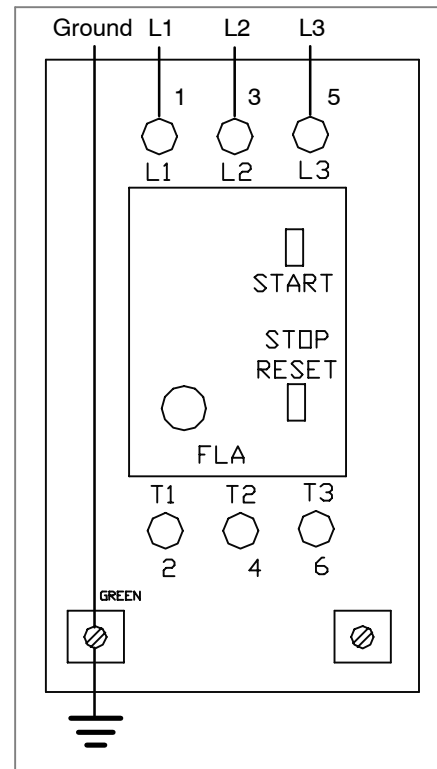

Figure 23



NOTE: The motor ground wire is also attached to left terminal marked \perp (Figure 23).

4. Attach ground wire to lower left terminal marked \perp (see Figure 23).
5. Install cover and tighten screws (AQ of Figure 22).

VFD Controllers

NOTE: Refer to VFD Controller Set-up, Operation & Maintenance Manual.

Preventive Maintenance & Adjustment

Required Tools

- Wrenches (for hexagon head fasteners)
7mm, 8mm, 10mm, 1/2", 9/16"
- Hex key wrenches (for set screws)
2mm, 2.5mm
- Straight edge
- Torque wrench

Timing Belt or Chain Replacement



Replace timing belt or chain following instructions:

- A – Timing Belt Replacement
- B – Timing Chain Replacement

A – Timing Belt Replacement

1. Loosen four screws (AL of Figure 24) and remove cover (N).

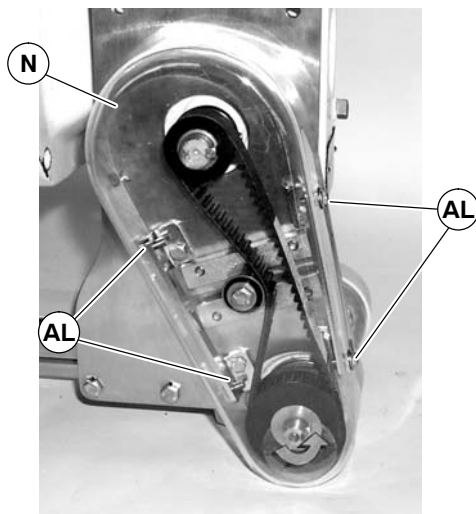

Figure 24

2. Loosen tensioner (AH of Figure 25).

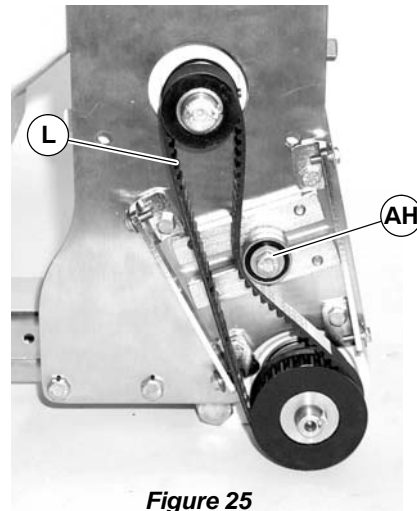

Figure 25

3. Remove timing belt (L).

NOTE: If timing belt does not slide over pulley flange, loosen two driven pulley set screws (AP of Figure 26) and remove pulley with belt. For belt and pulley installation, see steps 2 through 5 on page 7.

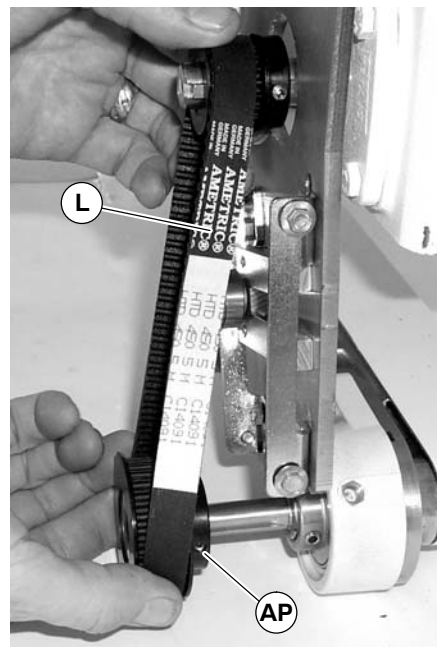

Figure 26

4. Install new timing belt (L).

- Depending on conveyor belt travel (direction 1 or 2 of Figure 27), locate timing belt tensioner (AH) as shown. Do not tighten tensioner screw.

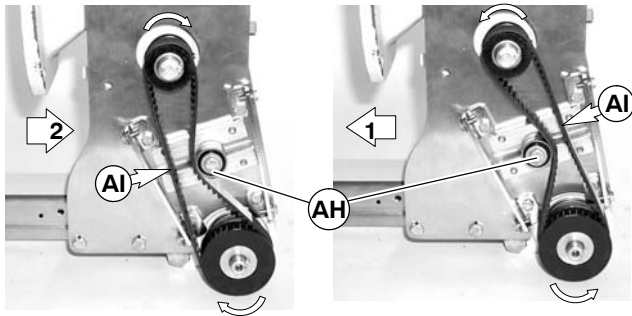

Figure 27

- Tension timing belt to obtain 1/8" (3 mm) deflection for 1 lb (4.3 N) of force at timing belt mid-point (AI). Tighten tensioner screw to 38 ft-lb (51 Nm).

NOTE: Do not over-tighten screws (AL of Figure 24).

- Attach cover (N of Figure 24) with four screws (AL). Tighten screws to 35 in-lb (4 Nm).

B – Timing Chain Replacement

- Loosen four screws (AL of Figure 28) and remove cover (N).

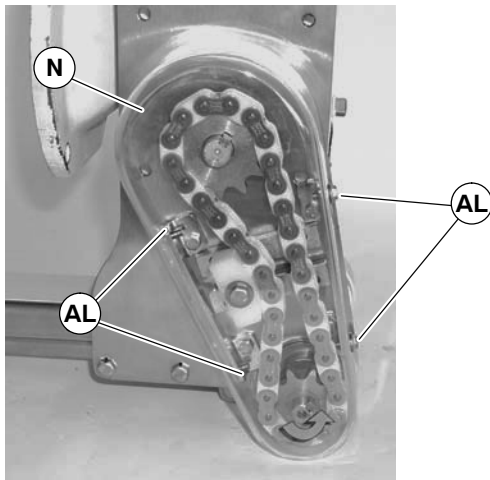

Figure 28

- Loosen timing chain tensioner (AN of Figure 29).

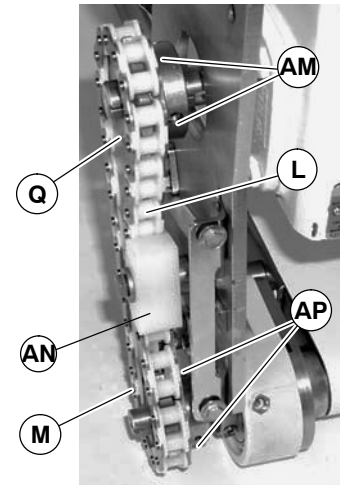

Figure 29

- Loosen four set screws (AM) and (AP).
- Remove timing chain (L) and sprockets (M and Q) from conveyor input shaft and gear reducer output shaft. Make sure to retain sprocket keys.
- Depending on conveyor belt travel (direction 1 or 2 of Figure 13), locate timing chain tensioner (AN) as shown. Do not tighten tensioner screw.

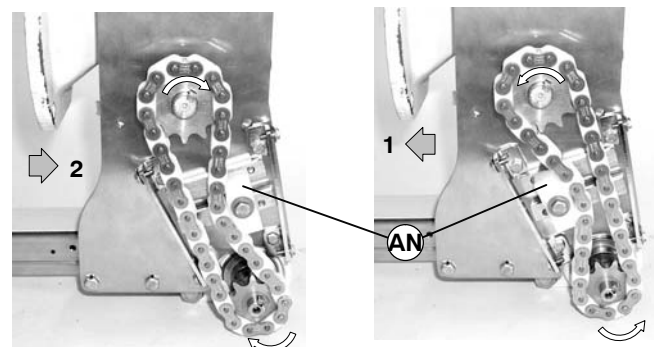

Figure 30

Preventive Maintenance & Adjustment

NOTE: Make sure sprocket keys are installed on conveyor input shaft (Z of Figure 31) and gear reducer output shaft (AO).

6. Install timing chain (L) over sprockets (M and Q). Install timing chain and sprockets on conveyor input shaft (Z) and gear reducer output shaft (AO). Do not tighten sprocket set screws.

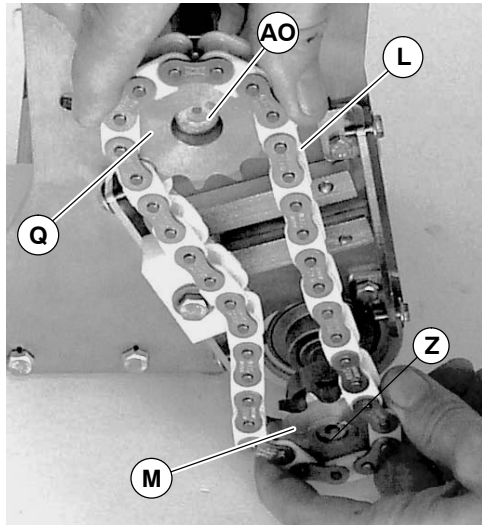

Figure 31

IMPORTANT: Make sure center of timing chain (L of Figure 32) aligns with center of chain tensioner (AN). If necessary, move drive sprocket (Q) in or out and then tighten set screws (AM). Also, if necessary, move driven sprocket (M) in or out and then tighten set screws (AP).

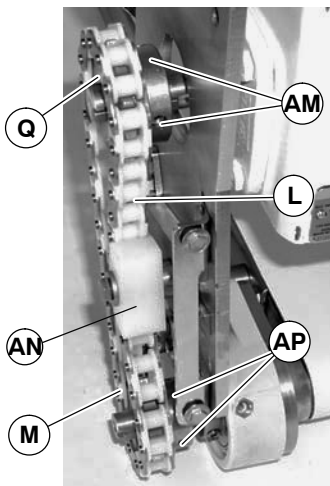

Figure 32

NOTE: Do not over-tension chain (L). Only tension chain until slack is removed.

7. Slide chain tensioner (AN) to take up chain slack. Tighten chain tensioner screw to 92 in-lb (10.4 Nm).

NOTE: Do not over-tighten screws (AL of Figure 28).

8. Install cover (N of Figure 28) and tighten four screws (AL) to 35 in-lb (4 Nm).

Timing Belt or Chain Tensioning

	<p>WARNING</p> <p>Exposed moving parts can cause severe injury.</p> <p>LOCK OUT POWER before removing guards or performing maintenance.</p>
---	---

NOTE: Figures 1 through 4 shown tensioning procedure for a timing belt. Tensioning a timing chain is similar except as noted.

1. Loosen four screws (AL of Figure 33) and remove cover (N).

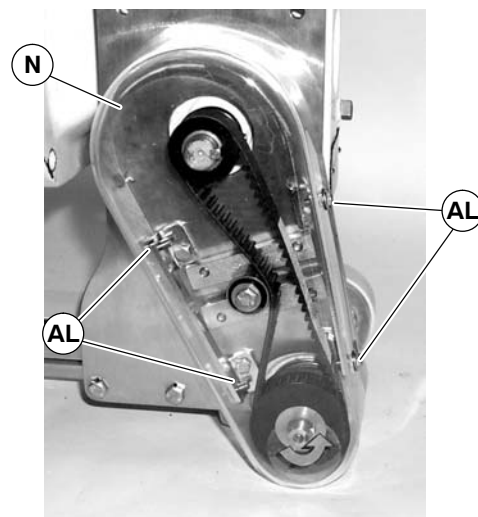

Figure 33

Preventive Maintenance and Adjustment

- Loosen belt tensioner (AH of Figure 34) or chain tensioner (AN of Figure 35).

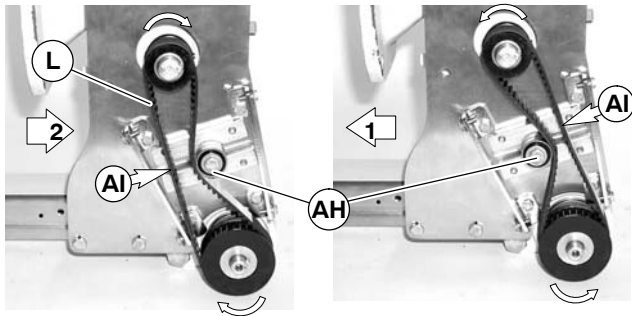

Figure 34

- For a Timing Belt** – Slide belt tensioner (AH) to obtain 1/8" (3 mm) deflection for 1.0 lb (456 grams) of force at belt mid-point (AI). Tighten tensioner screw to 103 in-lb (12 Nm).

NOTE: Do not overtension chain. Only tension chain until slack is removed.

- For a Timing Chain** – Slide chain tensioner (AN of Figure 35) to take up chain slack. Tighten chain tensioner screw to 92 in-lb (10.4 Nm).

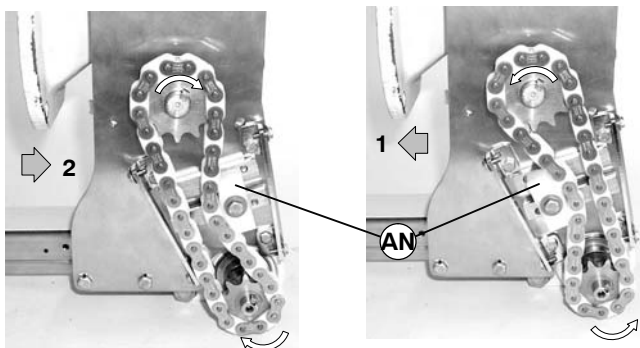

Figure 35

NOTE: Do not over-tighten screws (AL of Figure 33).

- Attach cover (N of Figure 33) with four (4) screws (AL). Tighten screws to 35 in-lb (4 Nm).

Gear Reducer Replacement



NOTE: Figures 36 through 38 shown gear reducer replacement procedure for a timing belt drive. Timing chain drive is similar except as noted.

- Perform steps 1 through 3 on page 12 to remove timing belt or steps 1 through 4 on page 13 to remove timing chain.
- For a Timing Belt** – Loosen two drive pulley set screws (AM of Figure 36) and remove drive pulley (Q).

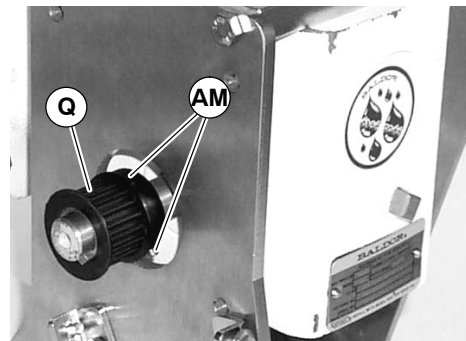

Figure 36

- Remove four screws and washers (P of Figure 37). Remove motor (R) from gear reducer (S).

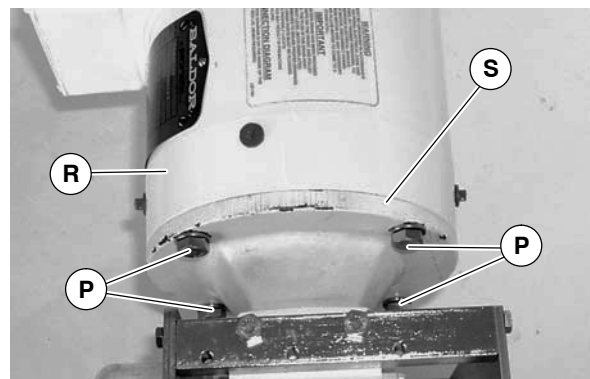

Figure 37

Preventive Maintenance and Adjustment

- Remove four (4) gear reducer mounting screws (AS of Figure 38). Remove gear reducer (S).

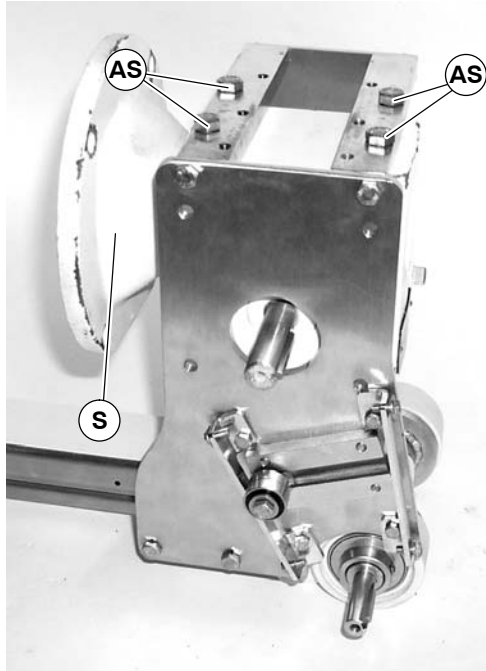

Figure 38

- Attach new gear reducer to bottom mount with four screws (AS).
- Install motor (refer to “Motor Installation” on page 9).
- For a Timing Belt** – Install drive pulley (Q of Figure 36) and tighten two set screws (AM).

NOTE: Install timing belt (refer to “A – Timing Belt Installation” on page 6.

Install timing chain (refer to “B – Timing Chain Installation” on page 8.

Motor Replacement

		<h3>WARNING</h3>
	<p>Exposed moving parts can cause severe injury. LOCK OUT POWER before removing guards or performing maintenance.</p>	

	<h3>DANGER</h3>
	<p>Hazardous voltage will cause severe injury or death. LOCKOUT POWER BEFORE before wiring.</p>

- Loosen terminal box screws (AT of Figure 39) and remove cover (AU).

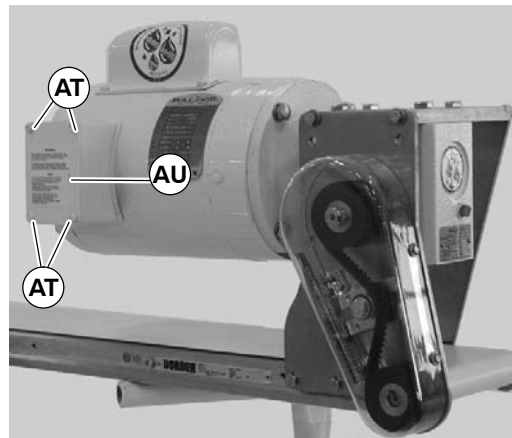

Figure 39

- Record incoming wire colors. Loosen wire nuts and remove wires.
- Loosen cord grip and remove cord.
- Remove screws and washers (P of Figure 40). Detach motor (R) from gear reducer (S). Retain motor output shaft key (O of Figure 41).

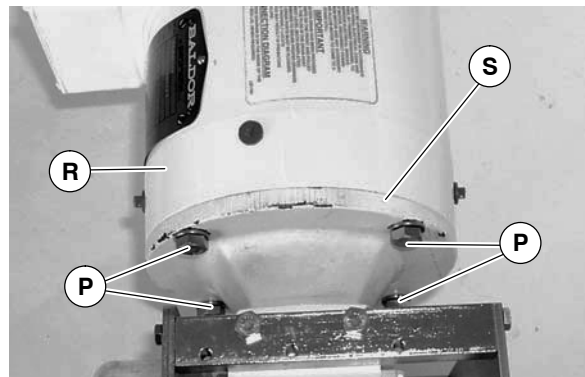

Figure 40

IMPORTANT: Be extremely careful when coupling motor to gear reducer. Avoid misalignment and forcing the connection causing possible permanent gear reducer seal damage.

5. Install key (O of Figure 41) in keyway. Slide new motor (R) into gear reducer (S). Secure motor with screws and washers (P).

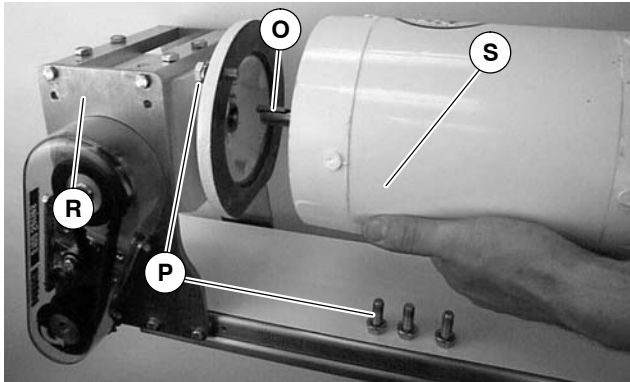



Figure 41

6. To install wiring, reverse steps 1, 2 and 3 on previous page.

Service Parts

NOTE: For replacement parts other than those shown in this section, contact an authorized Dorner Service Center or the factory. Key Service Parts and Kits are identified by the Performance Parts Kits logo . Dorner recommends keeping these parts on hand.

7200/7300 Series Drive Mounting Components

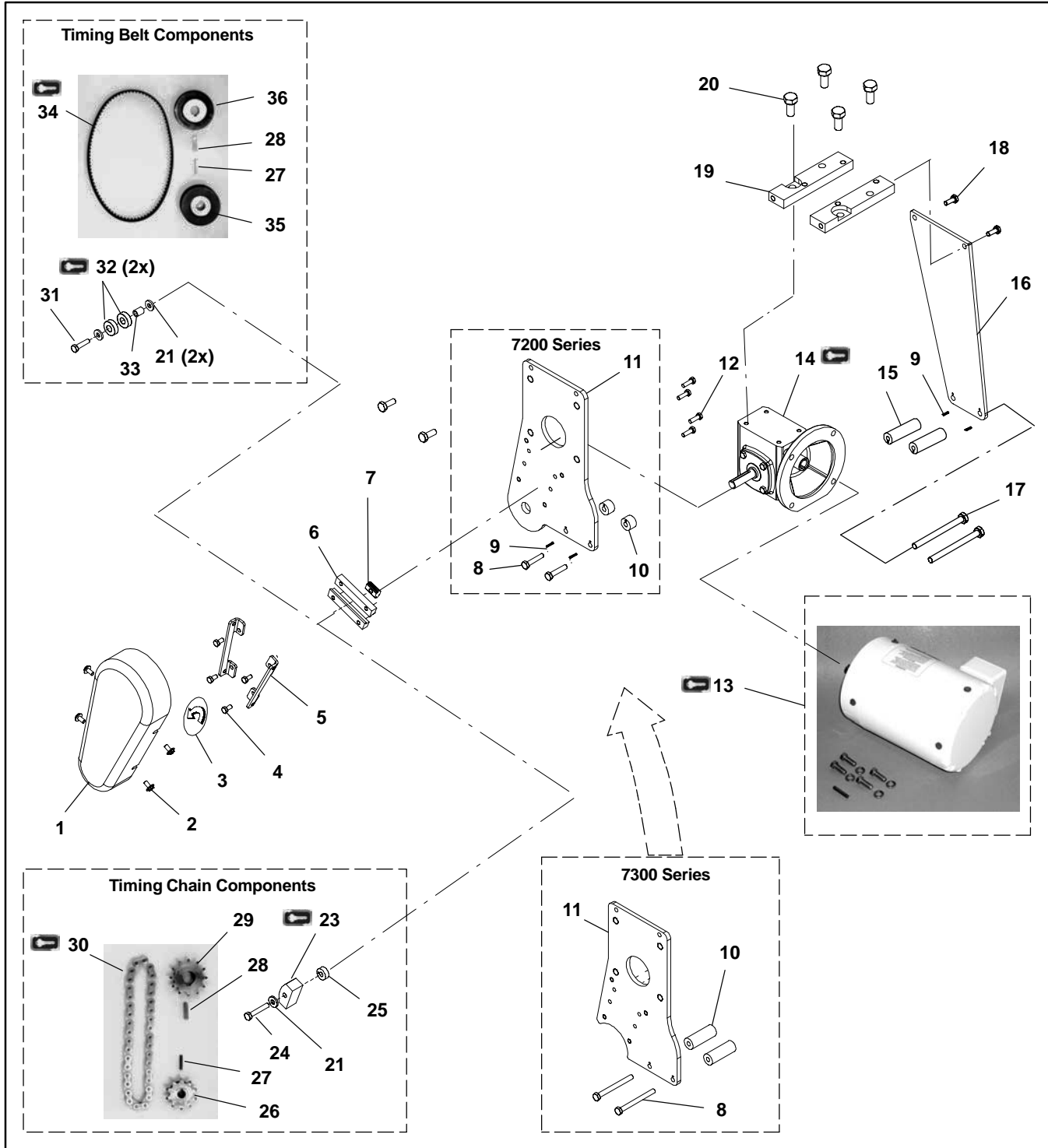

Service Parts

Item	Part Number	Description
1	450028P	Cover, Clear
2	807-968	Hex Flange Head Screw M5-.8x10mm
3	450272P	Rotation Label CW
	450273P	Rotation Label CCW
4	960510MSS	Hex Head Cap Screw M5-.8x10mm
5	450181MSS	Cover Mounting Bracket SS
6	450178MSS	Slide Bar, Tensioner
7	639971MSS	Drop-In T-Bar
8	960630MSS	Hex Head Cap Screw M6-1.0x30mm (7200 Series)
	960665MSS	Hex Head Cap Screw M6-1.0x65mm (7300 Series)
9	807-998	Grooved Pin SS (4x) (7200 Series)
	807-998	Grooved Pin SS (2x) (7300 Series)
10	456029	Spacer SS, 0.44" (11.2 mm) long (7200 Series)
	457850	Spacer SS, 1.76" (44.9 mm) long (7300 Series)
11	450179MSS	Drive Mounting Plate (7200 Series)
	701472	Drive Mounting Plate (7300 Series)
12	960516MSS	Hex Head Cap Screw M5-.8x16mm (4x)
13	62MZ411	Motor, 0.5 hp (0.37 kw), 115/208-230 Volts, 60 Hz, 1725 RPM (Includes mounting hardware and key)
	62MZ423	Motor, 0.5 hp (0.37 kw), 230/460 Volts, VFD, 10-60 Hz, Three-Phase, 1725 RPM (Includes mounting hardware and key)
	62MZD9DEN	Motor, 0.33 hp (0.25 kw), 90 Volts DC, 1750 RPM (Includes mounting hardware and key)
	62MZS423	Motor, 0.5 hp (0.37 kw), 230/460 Volts, 60 Hz, Three-Phase 1725 RPM SS (Includes mounting hardware and key)
14	62M005LZ	Gear Reducer, 5:1, 56C LH
	62M005RZ	Gear Reducer, 5:1, 56C RH
	62M015LZ	Gear Reducer, 15:1, 56C LH
	62M015RZ	Gear Reducer, 15:1, 56C RH
	62M050LZ	Gear Reducer, 50:1, 56C LH
	62M050RZ	Gear Reducer, 50:1, 56C RH
	62M005LZS	Gear Reducer, 5:1, 56C LH SS
	62M005RZS	Gear Reducer, 5:1, 56C RH SS
	62M015LZS	Gear Reducer, 15:1, 56C LH SS
	62M015RZS	Gear Reducer, 15:1, 56C RH SS
	62M050LZS	Gear Reducer, 50:1, 56C LH SS
	62M050RZS	Gear Reducer, 50:1, 56C RH SS

15	450184SS	Spacer SS, 2" (51 mm) long - 2" (51 mm) Wide Conveyor
	450183SS	Spacer SS, 3" (76 mm) long - 3" (76 mm) Wide Conveyor
	450182SS	Spacer SS, 0.25" (6.4 mm) long - 4" (102 mm) through 18" (457 mm) Wide Conveyor
16	450180SS	Drive Support Plate
17	960670MSS	Hex Head Cap Screw M6-1.0x70mm - 2" (51 mm) Wide Conveyor
	960645MSS	Hex Head Cap Screw M6-1.0x45mm - 3" (76 mm) Wide Conveyor
	960630MSS	Hex Head Cap Screw M6-1.0x30mm - 4" (102 mm) through 18" (457 mm) Wide Conveyor
18	960616MSS	Hex Head Cap Screw M6x16mm SS
19	See Support Bar Table	Gearhead Support Bar
20	906-124	Hex Head Cap Screw, 5/16-18x0.88"
21	911-201	Washer, SS 1/4"
23	456048	Chain Tensioner
24	960635MSS	Hex Head Cap Screw M6-1.0x35mm
25	450182SS	Drive Spacer SS
26	811-296	Driven Sprocket, 10 Tooth, 12mm Bore
27	980422MSS	Square Key, 4x22mm
28	912-084SS	Square Key, 3/16x1.5"
29	811-297	Drive Sprocket, 12 Tooth, 5/8" Bore
	811-300	Drive Sprocket, 18 Tooth, 5/8" Bore
	811-301	Drive Sprocket, 20 Tooth, 5/8" Bore
30	See Timing Chain Table	Timing Chain, #40 x 35 Pitch Length
31	960625MSS	Hex Head Cap Screw M6-1.0x25mm
32	802-123	Bearing (2x)
33	801-116	Nylon Bearing
34	See Timing Belt Table	Timing Belt, 15mm
35	450102	Driven Pulley, 22 Tooth, 12mm Bore
	450103	Driven Pulley, 28 Tooth, 12mm Bore
	450104	Driven Pulley, 32 Tooth, 12mm Bore
36	450397	Drive Pulley, 19 Tooth, 5/8" Bore
	450399	Drive Pulley, 28 Tooth, 5/8" Bore
	450430	Drive Pulley, 44 Tooth, 5/8" Bore
	450431	Drive Pulley, 48 Tooth, 5/8" Bore

(Continued)

Service Parts

Item 19: Support Bar		
Conveyor Width	Part Number 7200	Part Number 7300
2" (51 mm)	456502MSS	457702MSS
3" (76 mm)	RH - 456501MSS	RH - 457701MSS
	LH - 456503MSS	LH - 457703MSS
4" (102 mm)	456502MSS	457702MSS
5" (127 mm)	456505MSS	457705MSS
6" (152 mm)	456506MSS	457706MSS
8" (203 mm)	456508MSS	457708MSS
10" (254 mm)	456510MSS	457710MSS
12" (305 mm)	456512MSS	457712MSS
18" (457 mm)	456518MSS	457718MSS



Item 34: Standard Timing Belts			
Pulley Teeth		Belt Length	Part Number
Drive Pulley	Driven Pulley		
19	32	450 mm	814-104
28	32	475 mm	814-065
44	22	500 mm	814-101
44	28	500 mm	814-101
44	32	520 mm	814-108
48	22	500 mm	814-101



Item 30: Standard Timing Chains			
Sprocket Teeth		Pitch Length	Part Number
Drive Sprocket	Driven Sprocket		
22	10	35	456050
18	10	39	456053
20	10	39	456053

Return Policy

Returns must have prior written factory authorization or they will not be accepted. Items that are returned to Dorner without authorization will not be credited nor returned to the original sender. When calling for authorization, please have the following information ready for the Dorner factory representative or your local distributor:

1. Name and address of customer.
2. Dorner part number(s) of Item(s) being returned.
3. Reason for return.
4. Customer's original order number used when ordering the item(s).
5. Dorner or distributor invoice number.

A representative will discuss action to be taken on the returned items and provide a Returned Goods Authorization number for reference.

There will be a return charge on all new undamaged items returned for credit where Dorner was not at fault. Dorner is not responsible for return freight on such items.

Conveyors and conveyor accessories

Standard catalog conveyors	30%
MPB Series, cleated and specialty belt conveyors	50%
7400 & 7600 Series conveyors	non-returnable items
Engineered special products	case by case
Drives and accessories	30%
Sanitary stand supports	non-returnable items

Parts

Standard stock parts	30%
MPB, cleated and specialty belts	non-returnable items

Returns will not be accepted after 60 days from original invoice date.

The return charge covers inspection, cleaning, disassembly, disposal and reissuing of components to inventory.

If a replacement is needed prior to evaluation of returned item, a purchase order must be issued. Credit (if any) is issued only after return and evaluation is complete.

Dorner has representatives throughout the world. Contact Dorner for the name of your local representative. Our Technical Sales, Catalog Sales and Service Teams will gladly help with your questions on Dorner products.

For a copy of Dorner's Warranty, contact factory, distributor, service center or visit our website at www.dorner.com.

**For replacement parts, contact an authorized
Dorner Service Center or the factory.**

DORNER[®]

Dorner Mfg. Corp. reserves the right to change or discontinue products without notice. All products and services are covered in accordance with our standard warranty. All rights reserved. © Dorner Mfg. Corp. 2000

DORNER MFG. CORP.

975 Cottonwood Ave., PO Box 20
Hartland, WI 53029-0020 USA

USA

TEL 1-800-397-8664 (USA)

FAX 1-800-369-2440 (USA)

Internet: www.dorner.com

Outside the USA:

TEL 1-262-367-7600

FAX 1-262-367-5827