

Accessory Setup & Installation Guide

Emergency Stop Kit, Illuminated (75-40)

The Illuminated Emergency Stop (E-Stop) Kit is a pre-packaged and pre-wired electrical signalling assembly that can be installed on a Dorner 2100 or 3100 Series Conveyor or Stand.

This Kit includes instructions, Illuminated E-Stop Pushbutton Box assembly, Cabling, Brackets, Tools and Metric Mounting Hardware to aid in the installation and inter-connection with a Dorner *impac* Conveyor Controller.

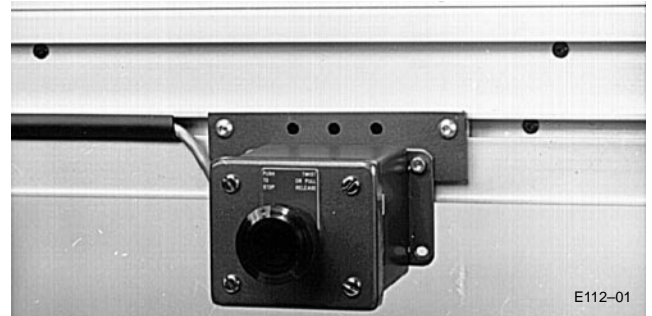

Figure 1: Illuminated E-Stop Kit Installed (75-40)

Additional Tools Needed for Installation

- Small flat-bladed screwdriver
- Adjustable wrench
- Permanent marking pen
- Electrical tape

Illuminated E-Stop Specifications

Manufacturer: Allen Bradley, IEC Pushbutton
UL/CSA Approved

Type: 800E Line

Pilot Light: 24 Volts DC Red LED

Supply Voltage: 24 Volts DC

Output Configuration: 1 N.O. & 1 N.C. Contact

Contact Type: Maintained

Contact Rating: 10 Ampere (Continuous)

Housing: NEMA 12/IP65

Item	Qty.	Description
A	7	Single Drop-In T-bar (639971M)
B	1	Stop Mounting Plate (677438M)
C	2	M6 x 16 mm Button Head Screw (910616M)
D	2	Stop Mounting Bracket (677436M)
E	2	M5 x 8 mm Soc. Hd. Cap Screw (920508M)
F	4	M5 x 6 mm Soc. Hd. Cap Screw (920506M)
G	1	Pushbutton Box Consisting of: Box & Cover (677437M), Pushbutton & Ring (830-142), Legend Plate (677784P), Power Module (830-147), N.O Contact Block (830-145), N.C. Contact Block (830-146), & 30 ft (9 m) Cord & Cord Grip Assembly (677733)
H	5	M6 x 10 mm Button Head Screw (910610M)
I	5	Zip Tie Mount (805-608)
J	5	Zip Tie (805-063)
K	1	4 mm Hex Key Wrench (807-564)
L	2	Label (823-107)
M	5	T-slot Cover Strip (675232)
N	2	M6 Spring Nut (990605M)

Covered under patent numbers 156,260 & 174,435 and corresponding patents and patent applications in other countries.

Figure 2: Illuminated E-Stop Kit (75-40) Components

E-Stop Installation/Testing/Operation

! **WARNING** !

Disconnect power to the Conveyor and to the *impac* Conveyor Controller. Due to the wide variety of setups & applications, guarding is the responsibility of the end user.

NOTE:

For shipping, T-bars (A) are pre-assembled to Mounting Plate (B), Plate is pre-assembled to Mounting Brackets (D) & Brackets are pre-assembled to Box assembly. Detach T-bars and attaching hardware before proceeding.

Accessory Setup & Installation Guide

1. Verify all kit parts are present.
2. Select the desired location and mount the E-Stop Kit either in the conveyor T-slot or on any one of the aluminum or steel Support Stand Vertical Legs (Figures 4 through 9).

Vertical Mounting in Conveyor T-slot

- a. Insert the two Single Drop-in T-bars into conveyor T-slot by rolling each one into position (Figure 3).

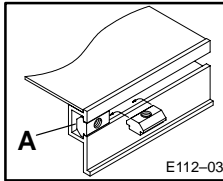

Figure 3: Drop-in T-bar Installation Detail

- b. Select the desired location and attach the unit to the conveyor T-slot in the manner shown in Figure 4. Attach the Pushbutton Box assembly with Mounting Brackets (in the same way it was packaged, when shipped) to the two Single Drop-in T-bars, using the M6 x 16 mm Button Head Cap Screws (C). Tighten Screws with 4 mm Hex Key Wrench (K) provided.

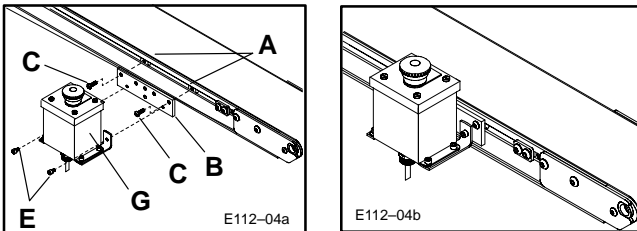

Figure 4: E-Stop Vertical Mounting to Conveyor T-slot

Horizontal Mounting in Conveyor T-slot

- a. Refer to Figure 5 and disassemble and re-attach Pushbutton Box assembly to the Mounting Plate and Mounting Brackets in the manner shown.
- b. Insert the two Single Drop-in T-bars into conveyor T-slot by rolling each one into position (Figure 3).
- c. Then, refer to Figure 5 and attach assembly to the two Single Drop-in T-bars, using the M6 x 16 mm Button Head Cap Screws. Tighten Screws with 4 mm Hex Key Wrench provided.

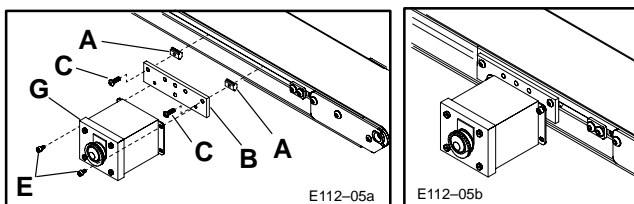

Figure 5: E-Stop Horizontal Mounting to Conveyor T-slot

Vertical Mounting to Aluminum Stand Leg

- a. For an aluminum Leg, select desired location and insert the two Single Drop-in T-bars into Leg channel by rolling each of them into position (see Figure 7).
- b. Attach the Pushbutton Box assembly to the Leg channel in the manner shown in Figure 6. Attach the Pushbutton Box assembly with Mounting Brackets (in the same way it was packaged, when shipped) to the two Single Drop-in T-bars, using the M6 x 16 mm Button Head Cap Screws. Tighten Screws with 4 mm Hex Key Wrench provided.

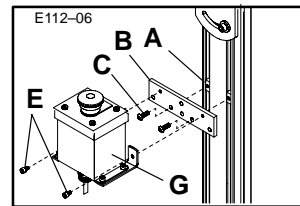

Figure 6: E-Stop Vertical Mounting to Aluminum Support Stand Leg

Horizontal Mounting to Aluminum Stand Leg

- a. Refer to Figure 7 and disassemble and re-attach Pushbutton Box assembly to the Mounting Plate and Mounting Brackets in the manner shown.
- b. Then, attach assembly to the Single Drop-in T-bars, using the M6 x 16 mm Button Head Cap Screws (Figure 7). Tighten Screws with 4 mm Hex Key Wrench provided.

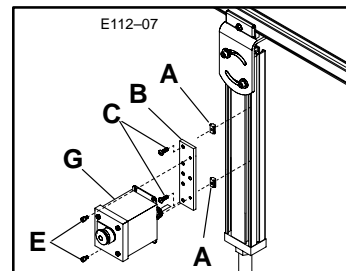

Figure 7: E-Stop Horizontal Mounting to Aluminum Stand Leg

Vertical Mounting to Steel Stand Leg

- a. For a Steel Leg channel, select the desired location and position and install two (2) M6 Spring Nuts (N) into the Leg slot (Figure 9).
- b. Attach the unit to the Leg channel in the manner shown in Figure 8. Attach the Pushbutton Box assembly with Mounting Brackets (in the same way it was packaged, when shipped) to the two Spring Nuts, using the M6 x 16 mm Button Head Cap Screws. Tighten Screws with 4 mm Hex Key Wrench provided.

Accessory Setup & Installation Guide

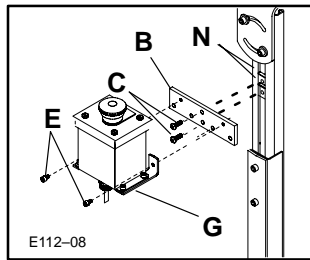

Figure 8: E-Stop Vertical Mounting to Steel Stand Leg

Horizontal Mounting to Steel Stand Leg

- Refer to Figure 9 and disassemble and re-attach Push-button Box assembly to the Mounting Plate and Mounting Brackets in the manner shown.
- Then, attach assembly to the M6 Spring Nuts, using the M6 x 16 mm Button Head Cap Screws (Figure 9). Tighten Screws with 4 mm Hex Key Wrench provided.

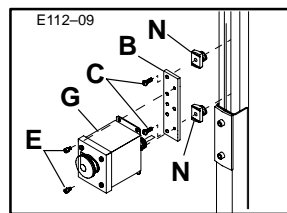

Figure 9: E-Stop Horizontal Mounting to Steel Stand Leg

3. Route the cable from the E-Stop to the *impac* Conveyor Controller.

- Cable routing should not run near any moving Conveyor parts, where it could possibly be damaged or cause damage to the Conveyor.
- The Conveyor T-Slot channel or optional 6 ft (1829 mm) or 12.5-ft (3810 mm) Wire Troughs (Dorner #75-85-6 or #75-85-12) can be used to route wire. For additional Wire Trough information, refer to separate Setup & Installation Guide (not provided).
- To contain a long run of wiring cable in the conveyor T-slot channel, use several short lengths of T-slot Cover Strips (M) (Figure 10). Or, to completely contain a long run of cable, purchase T-slot Cover Strip (645656P) at length required.

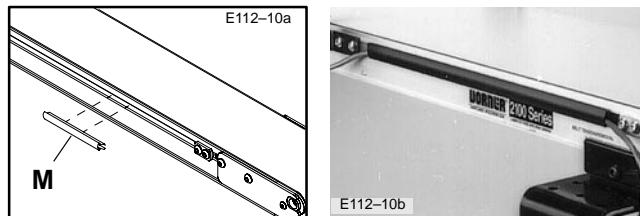

Figure 10: T-slot Cover Strip Mounting Detail

- To route Cable over a previously mounted component or to anchor the Cable, use the Zip Tie Mounts (I) and Single Drop-in T-bars, (Figure 11). Secure each Zip Tie Mount with an M6 x 10 mm Button Head Cap Screw (H). Tighten the Screws with the 4 mm Hex Key Wrench provided.

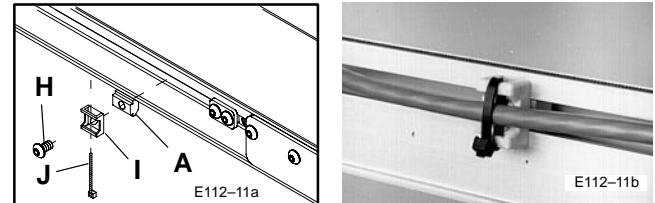

Figure 11: Zip Tie Mounting Detail

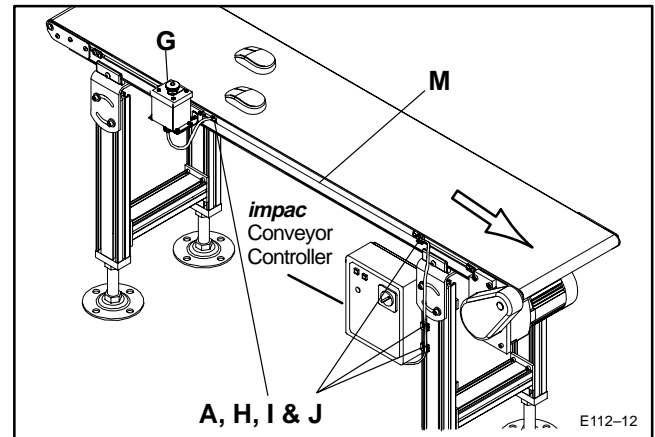

Figure 12: E-Stop Cable Routing to *impac* Conveyor Controller

- Figure 12 shows a typical wire routing of a E-Stop connection to an *impac* Conveyor Controller using the Conveyor's T-slot with both T-slot Cover Strips and Zip Ties (J).

4. Install the Cable into the *impac* Conveyor Controller.

- Using a flat-bladed screwdriver, remove the knock-out plug from bottom of *impac* controller.
- Remove the Locknut (Figure 14), from the Cord Grip, and insert the Cord Grip through the hole at the bottom of the controller cabinet. Attach and tighten the Locknut with an adjustable wrench.
- Extra Cable should be neatly and securely coiled up behind the *impac* Conveyor Controller cabinet. Mount a Zip Tie Mount to one of the tapped holes on the mounting brackets on the rear of the *impac* Conveyor Controller. Then, use a Wire Tie to anchor the extra Cable to the Zip Tie Mount.

Accessory Setup & Installation Guide

5. Label both ends of the E-Stop Cable with the blank Labels (L) provided (Figure 13), using a permanent marking pen.

The Label should be wrapped around the Cable near the Photo-Eye and inside the *impac* Conveyor Controller to identify the Cable. When multiple Kits are used, make sure all Cables are uniquely labelled. (i.e., K1 for Kit #1, K2 for Kit #2,... etc.).

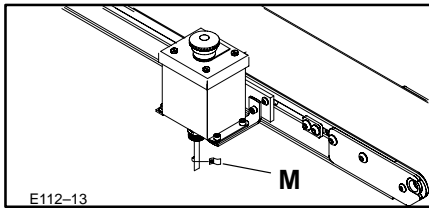

Figure 13: Cable Labeling (Detail provided only on E-Stop End of Cable)

NOTE:

The following connections are for a sample application that requires conveyor to stop when E-Stop Pushbutton is pressed. Refer to the *impac* Application Guide for details on other application designs and wiring connections.

When inserting a wire into a Terminal Block termination, be sure to tightly anchor the wire by tightening the screw and double-check that wire has been fully secured by giving it a light tug.

6. Wire the E-Stop to the *impac* Conveyor Controller Terminal Block (Figure 14).

Use the flat-bladed screwdriver furnished with the *impac* Conveyor Controller kit. As necessary, use the wiring diagram shown in the *impac* Application Guide for your particular application.

- a. Remove factory jumper from between terminals ES1 and ES2.
- b. Insert wire #2 (Black) into the terminal COM.
- c. Insert wire #2 (Red) into the terminal 24V.
- d. Insert wire #4 (Brown) into the terminal ES1.
- e. Insert wire #5 (White) into the terminal ES2.
- f. Wire #3 (Green) should be individually taped-off since it is not used in this application.

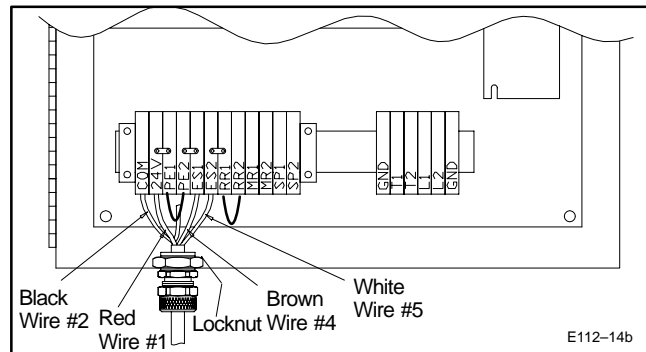
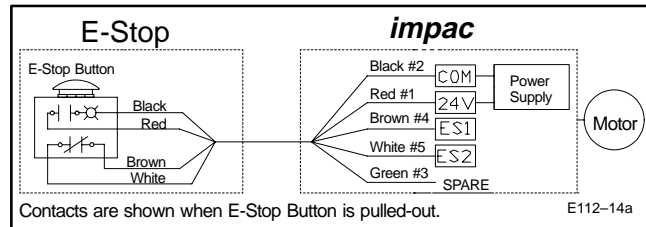

Figure 14: Sample E-Stop to *impac* Wiring Connections

7. Test operation as follows:

- a. Be sure the *impac* On/Off Switch is OFF and that conveyor is ready to run. Then, begin the test by re-connecting power to the *impac*. Do not turn on power at this time. Keep the *impac* On/Off Switch OFF.
- b. Operation of the conveyor may vary depending on the chosen application. Consult the *impac* Application Guide for your particular application.
- c. Shown here is an application using an E-Stop to stop a conveyor (Figure 12).
- d. Turn *impac* On/Off Switch to ON.
- e. Test E-Stop on/off operation by pressing and resetting E-Stop Pushbutton. When Pushbutton is pressed, conveyor should stop running and Button should illuminate. When Button is reset (pulled-out), conveyor should start running and Button Light should go out.
- f. After correct operation is exhibited, normal operation processes can be continued.