



Motor Controls

Installation, Maintenance and Parts Manual



Single Input VFD Motor Controller



Dual Input VFD Motor Controller

DORNER MFG. CORP.
P.O. Box 20 • 975 Cottonwood Ave.
Hartland, WI 53029-0020 USA

INSIDE THE USA
TEL: 1-800-397-8664
FAX: 1-800-369-2440

OUTSIDE THE USA
TEL: 262-367-7600
FAX: 262-367-5827

For other service manuals visit our website at:
www.dorner.com/service_manuals.asp

Table of Contents

Warnings – General Safety.....	3	Controller Setup	8
Product Description	4	Single Input VFD Motor Control	8
Specifications	5	Dual Input VFD Motor Control.....	9
Installation	6	Indexing Time Delay Adjustment	9
Required Tools.....	6	Conveyor Reversing	10
Conveyor Mounting	6	Remote Machine Interface Terminals	10
Stand Mounting.....	6	Service Parts.....	12
Wiring	7	Single Input VFD Motor Control	12
115V Controllers	7	Dual Input VFD Motor Control.....	13
230V and 460V Controllers	7	Return Policy.....	14
Preventative Maintenance and Adjustment.....	8		
Required Tools.....	8		

Introduction

CAUTION
Some illustrations may show guards removed. DO NOT operate equipment without guards.

Upon receipt of shipment:

- Compare shipment with packing slip. Contact factory regarding discrepancies.
- Inspect packages for shipping damage. Contact carrier regarding damage. Accessories may be shipped loose.
- See accessory instructions for installation.

The Dorner Limited Warranty applies.

Dorner 7400 Series conveyors have patents pending.

Dorner reserves the right to make changes at any time without notice or obligation.

Dorner has convenient, pre-configured kits of Key Service Parts for all conveyor products. These time saving kits are easy to order, designed for fast installation, and guarantee you will have what you need when you need it. Key Parts and Kits are marked in the Service Parts section of this manual with the Performance Parts Kits logo .

Warnings – General Safety

WARNING

The safety alert symbol, black triangle with exclamation, is used to alert you to potential personal injury hazards.

DANGER



SEVERE HAZARD!

KEEP OFF CONVEYORS. Climbing, sitting, walking or riding on conveyor will cause severe injury.

DANGER



EXPLOSION HAZARD!

- **DO NOT OPERATE CONVEYORS IN AN EXPLOSIVE ENVIRONMENT.** The electric gearmotor generates heat and could ignite combustible vapors.
- Failure to comply will result in death or serious injury.

WARNING

Controller must be properly grounded. Failure to properly ground controller may cause personal injury.

DANGER



SEVERE HAZARD!

Hazardous voltage will cause severe injury or death. **LOCKOUT POWER BEFORE WIRING.**

WARNING



SEVERE HAZARD!

Exposed moving parts can cause severe injury. **DO NOT ATTEMPT ADJUSTMENTS WITH CONVEYOR RUNNING. LOCK OUT POWER** before removing guards or performing maintenance.

WARNING



SEVERE HAZARD!

- Dorner cannot control the physical installation and application of conveyors. Taking protective measures is the responsibility of the user.
- When conveyors are used in conjunction with other equipment or as part of a multiple conveyor system, **CHECK FOR POTENTIAL PINCH POINTS** and other mechanical hazards before system start-up.
- Failure to comply could result in serious injury.

Product Description

Single Input VFD Motor Control

Dorner's Single Input VFD Motor Controller (Figure 1) can be used with all industrial VFD gearmotors up to 1/2 Hp.

Typical Components

- 1 Power Switch
- 2 Fuse
- 3 Speed Control
- 4 Power Cord
- 5 Motor Cord
- 6 Sprint T-Nut (x2)
- 7 M6-1.00 x 16mm Socket Screws (x2)
- 8 Accessory Kit Interface Ports

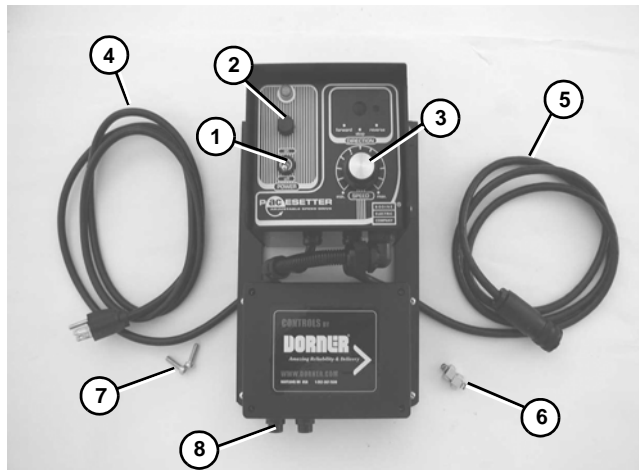

Figure 1

Dual Input VFD Motor Control

Dorner's Dual Input VFD Motor Controllers (Figure 2) can be used with all industrial VFD gearmotors.

Typical Components

- 1 Operator Keypad
- 2 Lockable Disconnect Switch
- 3 Accessory Kit Interface Ports
- 4 Sprint T-Nut (x2)
- 5 M6-1.00 x 16mm Socket Screws (x2)
- 6 Power Cord (115 volt only)
- 7 Motor Cord

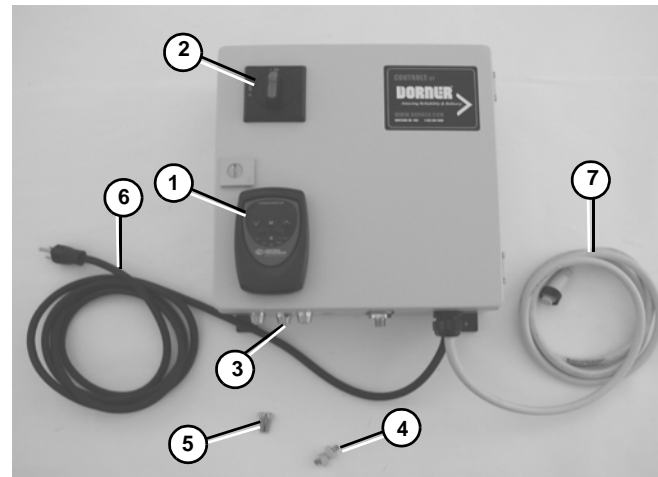

Figure 2

NOTE

For additional information refer to Bodine's Instructions for Installation & Operation Manual shipped with your controller.

Specifications

Model Number	Fig.	Input Voltage & Phase	Output Voltage & Phase	Output Frequency	Maximum HP (kW)	Maximum Amperes	Enclosure
75M-V1-3211-05	1	115 Volt, Single Phase	230 Volt, Three Phase	60 Hz	0.5 (0.37)	2.4	Nema 1
75M-V2-3211-05	2	115 Volt, Single Phase	230 Volt, Three Phase	60 Hz	1.0 (0.75)	4.0	Nema 12
75M-V2-3211-10	2	115 Volt, Single Phase	230 Volt, Three Phase	60 Hz	1.5 (1.12)	5.2	Nema 12
75M-V2-3232-10	2	230 Volt, Single / Three Phase	230 Volt, Three Phase	60 Hz	1.5 (1.12)	5.2	Nema 12
75M-V2-3232-20	2	230 Volt, Single / Three Phase	230 Volt, Three Phase	60 Hz	2.0 (1.50)	7.0	Nema 12
75M-V2-3434-10	2	460 Volt, Three Phase	460 Volt, Three Phase	60 Hz	1.5 (1.12)	2.8	Nema 12
75M-V2-3434-20	2	460 Volt, Three Phase	460 Volt, Three Phase	60 Hz	2.0 (1.50)	3.8	Nema 12

Installation

Required Tools

- 6 mm hex head wrench

Conveyor Mounting

1. Install spring t-nuts (Figure 3, item 1) into conveyor t-slot.

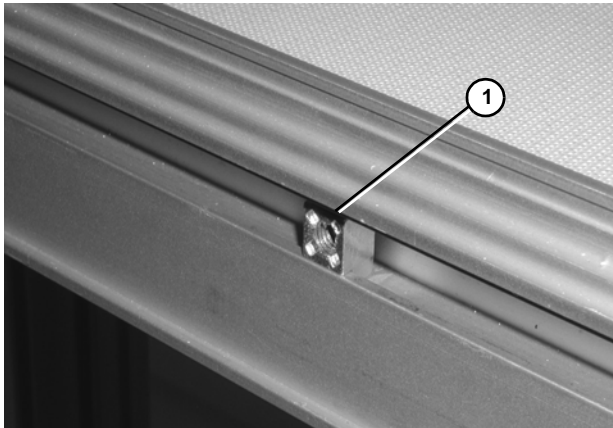

Figure 3

2. Attach controller (Figure 4, item 1) to conveyor with screws (Figure 4, item 2).

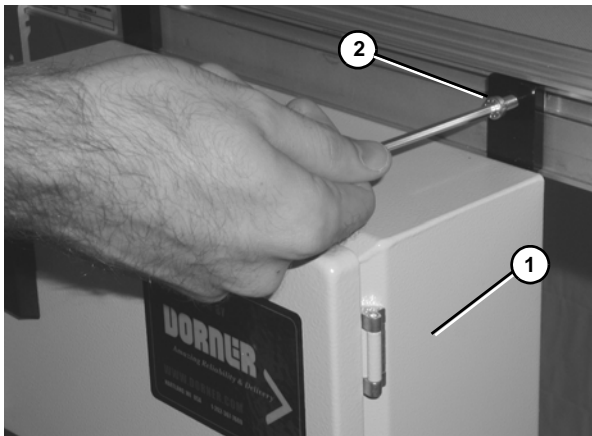

Figure 4

3. Slide controller to its desired mounting location along conveyor and tighten both screws.

Stand Mounting

1. Install spring t-nuts (Figure 5, item 1) into stand t-slot.

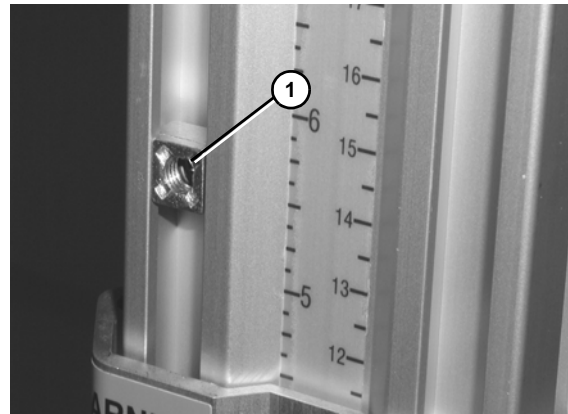

Figure 5

2. Partially thread controller mounting bar (Figure 6, item 1) to lower t-nut with screw (Figure 6, item 2).

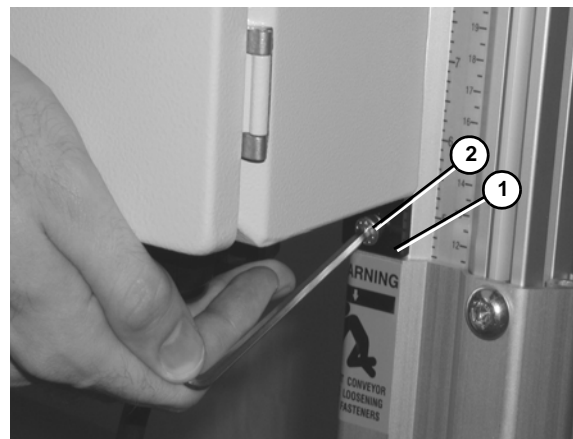

Figure 6

3. Install second spring t-nut into stand t-slot.
4. Partially thread controller mounting bar (Figure 7, item 1) to top t-nut with screw (Figure 7, item 2).

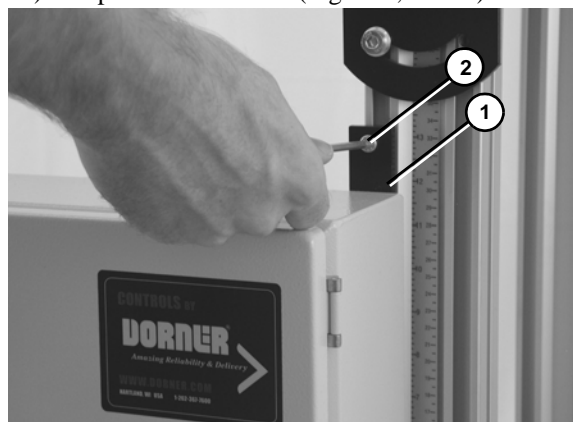

Figure 7

5. Slide controller to its desired mounting location and tighten both screws.

Wiring

DANGER

SEVERE HAZARD! Hazardous voltage will cause severe injury or death. LOCKOUT POWER BEFORE WIRING.

WARNING

SEVERE HAZARD! Exposed moving parts can cause severe injury. DO NOT ATTEMPT ADJUSTMENTS WITH CONVEYOR RUNNING. LOCK OUT POWER before removing guards or performing maintenance.

WARNING
Controller must be properly grounded. Failure to properly ground controller may cause personal injury.

For 115V Controllers:

1. Connect motor cord (Figure 8, item 1) to motor (Figure 8, item 2).

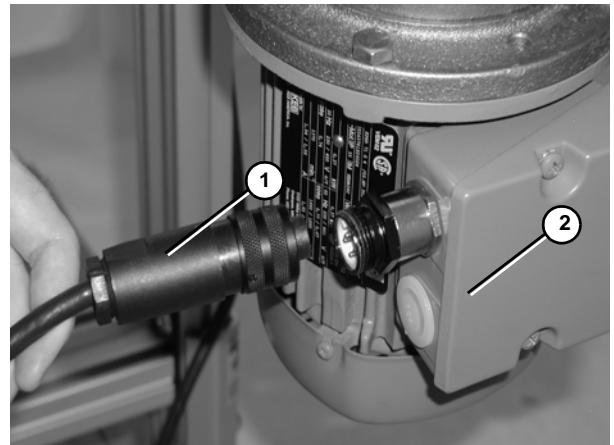

Figure 8

For 230V and 460V Controllers:

1. Make the input power connections through the line connection cord grip. Refer to Figure 9 for terminations inside the VFD controller. L1 = item 1, L2 = item 2, L3 = item 3 and Ground = item 4.

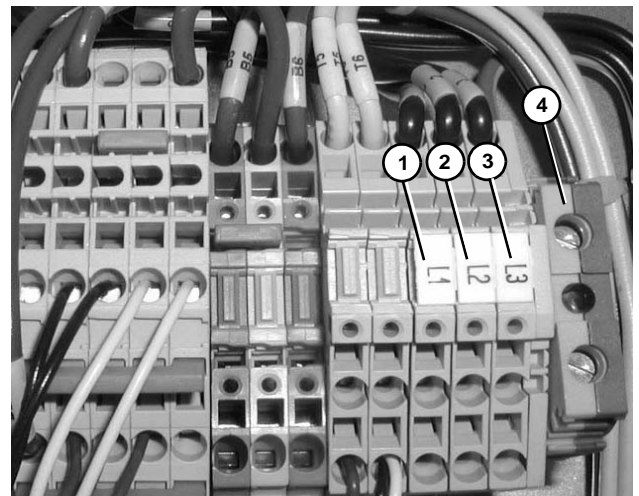

Figure 9



CAUTION
Do not disconnect motor power while motor is running. Damage to equipment could occur.

Preventive Maintenance and Adjustment

Required Tools

- Flat-blade screwdriver
- Phillips screwdriver

Controller Setup

DANGER

SEVERE HAZARD! Hazardous voltage will cause severe injury or death. LOCKOUT POWER BEFORE WIRING.
WARNING

SEVERE HAZARD! Exposed moving parts can cause severe injury. DO NOT ATTEMPT ADJUSTMENTS WITH CONVEYOR RUNNING. LOCK OUT POWER before removing guards or performing maintenance.
NOTE
<i>For additional information or desired settings other than listed refer to information provided by controller manufacturer.</i>

When purchased with a gearmotor, Dorner configures Variable Speed VFD Controllers as follows:

- 1 second acceleration time
- 1 second deceleration time
- Minimum frequency @ 6 Hz
- Maximum frequency @ 60 Hz
- Overloads set to motor Full Load Amperes (FLA)

Single Input VFD Motor Control

Acceleration (Figure 10, item 1)

Turn counter clockwise to reduce the time it takes to ramp up to speed. For more details please refer to Bodine's Instructions for Installation and Operation Manual section Adjust Trim Pots.

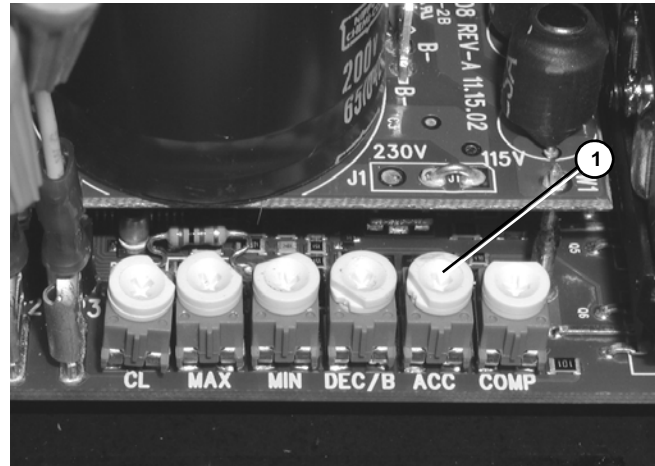

Figure 10

Deceleration (Figure 11, item 1)

Turn counter clockwise to reduce the time it takes to ramp down to a stop. For more details please refer to Bodine's Instructions for Installation and Operation Manual section Adjust Trim Pots.

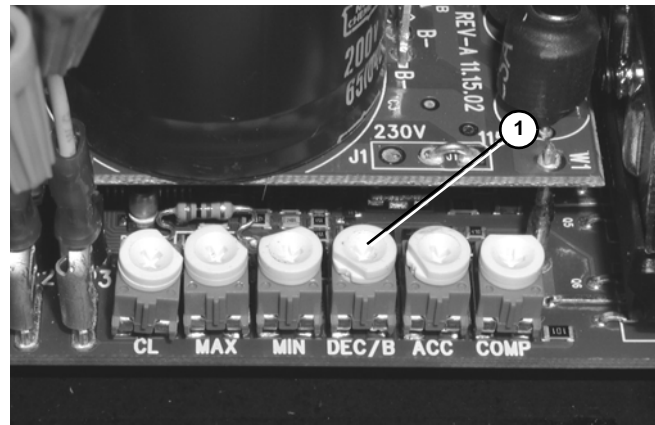

Figure 11

Preventive Maintenance and Adjustment

Dual Input VFD Motor Control

Acceleration

1. Press the M, mode key, (Figure 12, item 1) on the keypad to enter the programming mode. A flashing 01 will be displayed.



Figure 12

2. Press the up arrow key (Figure 12, item 2) until parameter 03, acceleration, is displayed.
3. Press the M key to change the acceleration value.
4. Use the up (Figure 12, item 2) and down (Figure 12, item 3) arrows to change the acceleration rate. Acceleration is displayed in seconds.
5. Press the M key to save changes.
6. Press the M key again to exit programming mode. RD (ready) will be displayed when in run mode.

Deceleration

1. Press the M, mode key, (Figure 12, item 1) on the keypad to enter the programming mode. A flashing 01 will be displayed.
2. Press the up arrow key (Figure 12, item 2) until parameter 04, deceleration, is displayed.
3. Press the M key to change the deceleration value.
4. Use the up (Figure 12, item 2) and down (Figure 12, item 3) arrows to change the deceleration rate. Deceleration is displayed in seconds.
5. Press the M key to save changes.
6. Press the M key again to exit programming mode. RD (ready) will be displayed when in run mode.

Indexing Time Delay Adjustment

Available on the dual input VFD motor controller only.

For “On Delay” (delay before conveyor starts)

1. Press the M, mode key (Figure 12, item 1) on the keypad to enter the programming mode. A flashing 01 will be displayed.
2. Press the up arrow key (Figure 12, item 2) until parameter 63, on delay, is displayed.
3. Press the M key to change the delay value.
4. Use the up (Figure 12, item 2) and down (Figure 12, item 3) arrows to change the delay rate. On delay is displayed in 1/10th of a second. (A value of 10 = 1 second)
5. Press the M key to save changes.
6. Press the M key again to exit programming mode. RD (ready) will be displayed with in run mode.

For “Off Delay” (delay before conveyor stops)

1. Press the M, mode key (Figure 12, item 1) on the keypad to enter the programming mode. A flashing 01 will be displayed.
2. Press the up arrow key (Figure 12, item 2) until parameter 64, off delay, is displayed.
3. Press the M key to change the delay value.
4. Use the up (Figure 12, item 2) and down (Figure 12, item 3) arrows to change the delay rate. Off delay is displayed in 1/10th of a second. (A value of 10 = 1 second)
5. Press the M key to save changes.
6. Press the M key again to exit programming mode. RD (ready) will be displayed when in run mode.

Preventive Maintenance and Adjustment

Conveyor Reversing

To change the direction of the conveyor belt without rewiring the motor or controller, use the directional jumper provided.

Single Input VFD Motor Controller:

For forward belt movement, install the jumper (Figure 13, item 1) between the FWD pin and center pin, the top two pins. For reverse belt movement, install the jumper between the REV pin and the center pin, the bottom two pins. (This jumper is removed when direction is controlled from the remote machine interface terminals.)

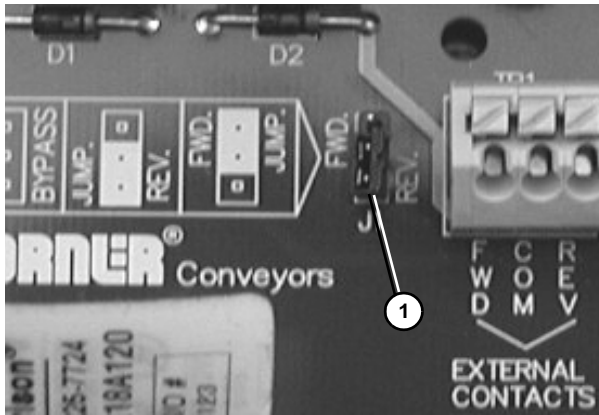
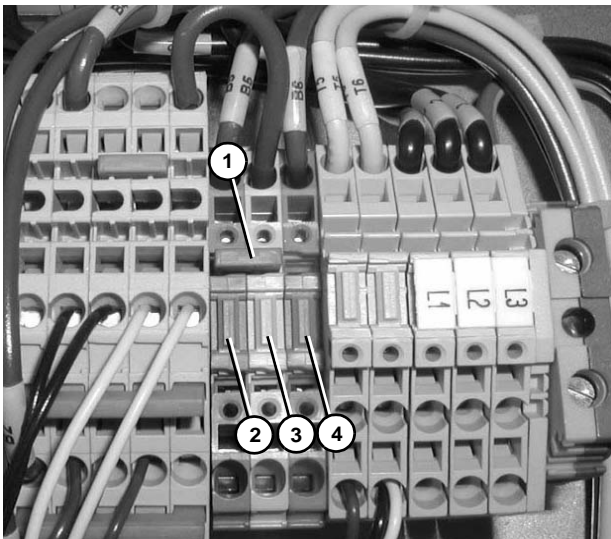

Figure 13

Dual Input VFD Motor Controller:

For forward belt movement, install the orange jumper (Figure 14, item 1) between the blue terminal (Figure 14, item 2) and white terminal (Figure 14, item 3), the left two terminals. For reverse belt movement, install the orange jumper between the orange terminal (Figure 14, item 4) and the white terminal (Figure 14, item 3), the right two terminals. (This jumper is removed when direction is controlled from the remote machine interface terminals.)

Figure 14



Remote Machine Interface Terminals

An external dry contact or contact closure can be used to run the conveyor in either the forward or reverse direction.

Single Input VFD Motor Controller:

NOTE

Remove the direction jumper 'J1' (Figure 15, item 1) from the pins. This jumper is not required.

Connect remote machine interface wires to the terminals labeled "External Contacts" (Figure 15, item 2).

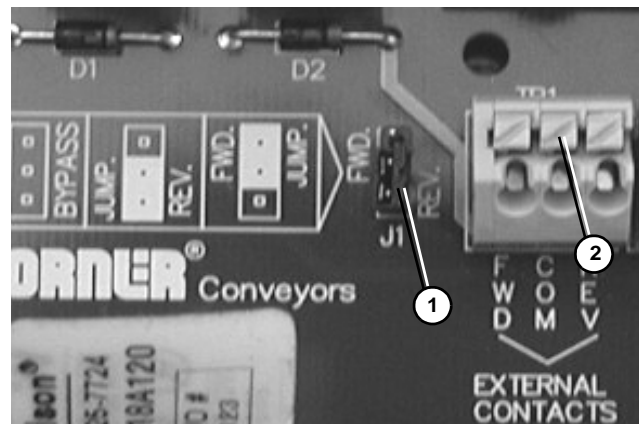

Figure 15

Closing a contact between the FWD and COM terminals will cause the control to run the motor in the forward direction.

Closing a contact between the COM and REV terminals will cause the control to run the motor in the reverse direction.

Preventive Maintenance and Adjustment

Dual Input VFD Motor Controller:

NOTE
<i>Remove the direction jumper (Figure 16, item 1) from the terminals. This jumper is not required.</i>

Remove the direction jumper (Figure 16, item 1) from the terminals. This jumper is not required.

Connect remote machine interface wires to the terminals (Figure 16, items 2, 3 and 4).

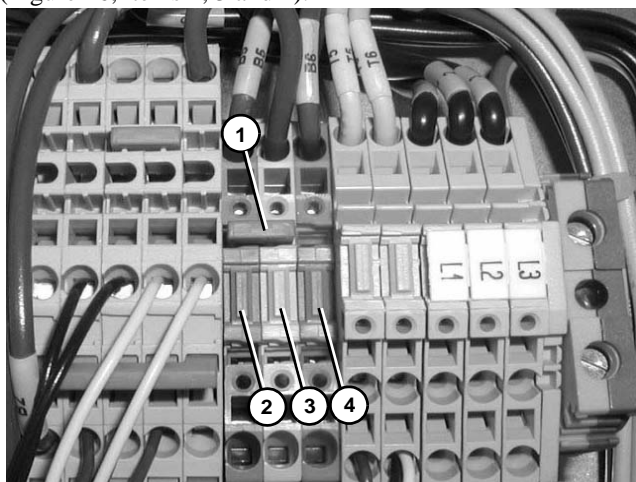



Figure 16

Closing a contact between the blue terminal (Figure 16, item 2) and the white terminal (Figure 16, item 3) will cause the control to run the motor in the forward direction.

Closing a contact between the white terminal (Figure 16, item 3) and the orange terminal (Figure 16, item 4) will cause the control to run the motor in the reverse direction.

Service Parts

NOTE

For replacement parts other than those shown in this section, contact an authorized *Dorner Service Center* or the factory. Key Service Parts and Kits are identified by the Performance Parts Kits logo . Dorner recommends keeping these parts on hand.

Single Input VFD Motor Control

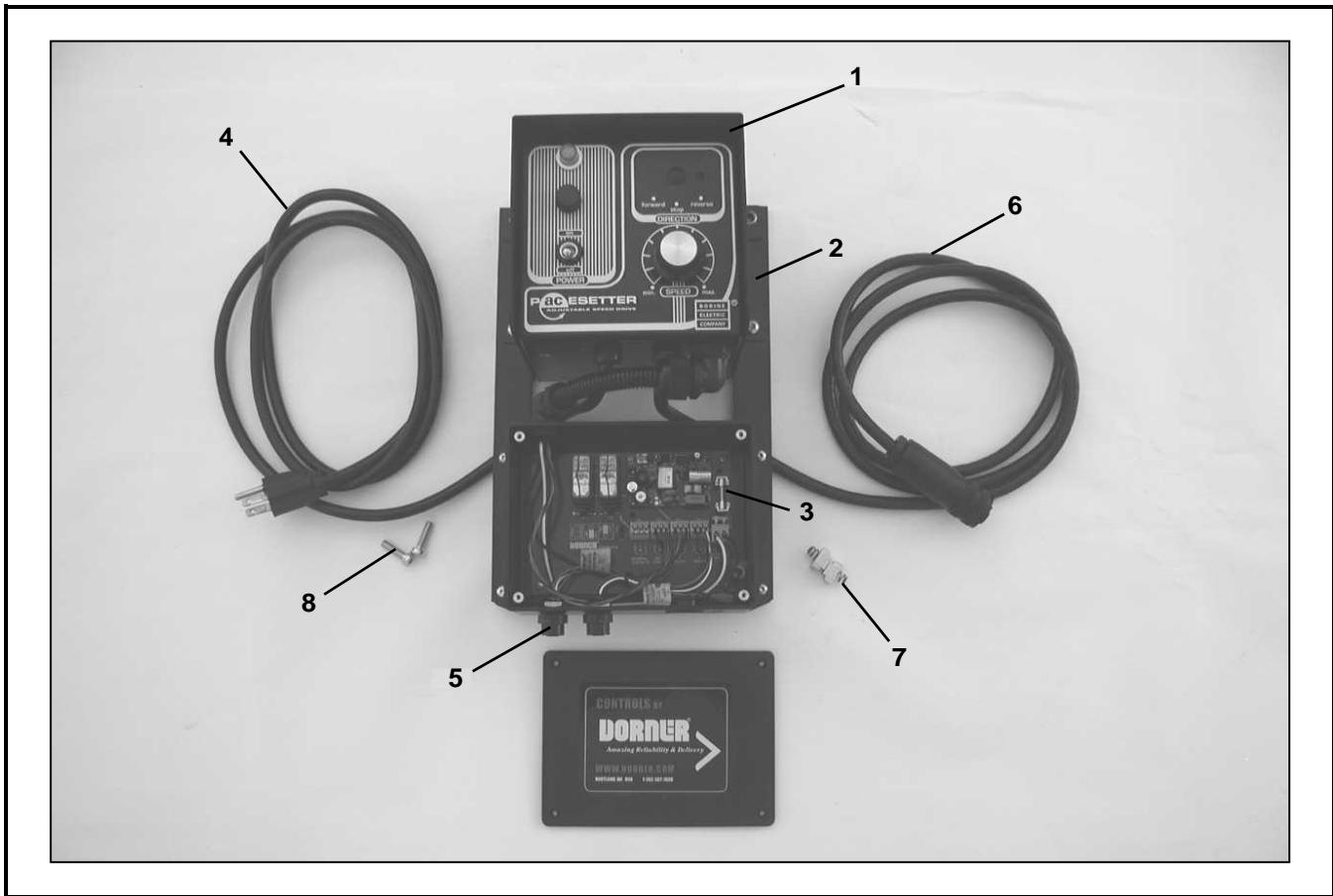

Item	Part Number	Description
1	827-2997	VFD Control
2	201101	Mounting Bracket
3	805-1167	Relay Interface/Power Supply
4	807-683	Plug
5	809-309	Accessory Kit Ports
6	809-310	Mini Power Connector
7	200124M	Spring T-Nut
8	920616M	Socket Screw M6-1.00 x 16mm

Dual Input VFD Motor Control

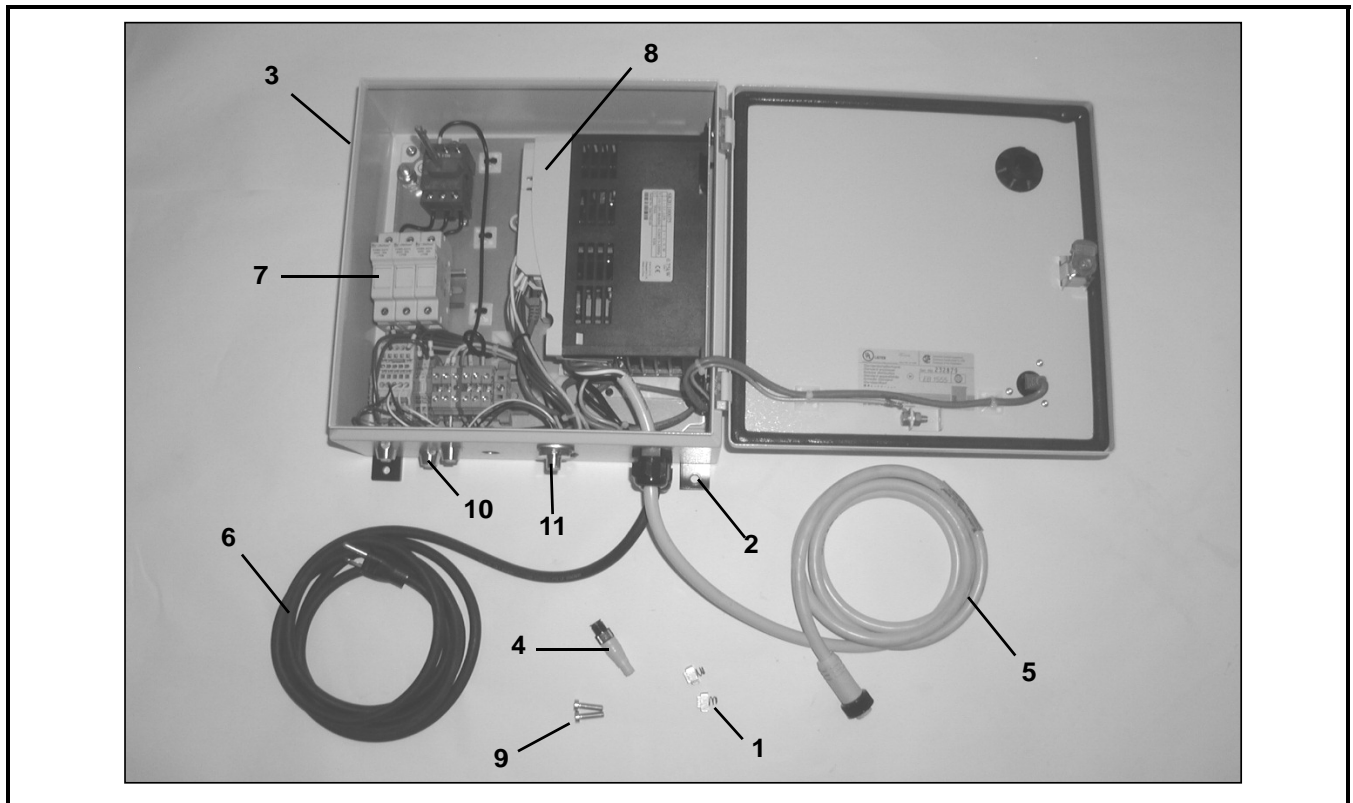

Item	Part Number	Description
1	200124M	Spring T-Nut
2	201109	Mounting Bracket
3	201110	Controls Enclosure
4	809-323	Terminator Plug
5	809-324	Female Mini Cable for 115 Volt and 230 Volt Controllers
	809-327	Female Mini Cable for 460 Volt Controllers
6	818-125	Power Cord for 115 Volt Controllers Only
7	819-103	15 Amp Fuse for 115 Volt and 230 Volt Controllers
	819-113	10 Amp Fuse for 460 Volt Controllers
8	826-511	115 Volt, 1 Hp VFD Controller
	826-512	115 Volt, 1.5 Hp VFD Controller
	826-513	230 Volt, 1.5 Hp VFD Controller
	826-514	230 Volt, 2 Hp VFD Controller
	826-515	460 Volt, 1.5 Hp VFD Controller
	826-516	460 Volt, 2 Hp VFD Controller
9	920616M	Socket Head Screw M6-1.00 x 16mm
10	809-309	Accessory Kit Ports
11	809-314	Motor Running Output Port

Return Policy

Returns must have prior written factory authorization or they will not be accepted. Items that are returned to Dorner without authorization will not be credited nor returned to the original sender. When calling for authorization, please have the following information ready for the Dorner factory representative or your local distributor:

1. Name and address of customer.
2. Dorner part number(s) of item(s) being returned.
3. Reason for return.
4. Customer's original order number used when ordering the item(s).
5. Dorner or distributor invoice number.

A representative will discuss action to be taken on the returned items and provide a Returned Goods Authorization number for reference.

There will be a return charge on all new undamaged items returned for credit where Dorner was not at fault. Dorner is not responsible for return freight on such items.

Conveyors and conveyor accessories

Standard catalog conveyors	30%
MPB Series, cleated and specialty belt conveyors	50%
7400 & 7600 Series conveyors	non-returnable items
Engineered special products	case by case
Drives and accessories	30%
Sanitary stand supports	non-returnable items

Parts

Standard stock parts	30%
MPB, cleated and specialty belts	non-returnable items

Returns will not be accepted after 60 days from original invoice date.

The return charge covers inspection, cleaning, disassembly, disposal and reissuing of components to inventory.

If a replacement is needed prior to evaluation of returned item, a purchase order must be issued. Credit (if any) is issued only after return and evaluation is complete.

Dorner has representatives throughout the world. Contact Dorner for the name of your local representative. Our Technical Sales, Catalog Sales and Service Teams will gladly help with your questions on Dorner products.

For a copy of Dorner's Warranty, contact factory, distributor, service center or visit our website at www.dorner.com.

For replacement parts, contact an authorized Dorner Service Center or the factory.



Dorner Mfg. Corp. reserves the right to change or discontinue products without notice. All products and services are covered in accordance with our standard warranty. All rights reserved. © Dorner Mfg. Corp. 2006

DORNER MFG. CORP.
975 Cottonwood Ave., PO Box 20
Hartland, WI 53029-0020 USA
USA
TEL 1-800-397-8664 (USA)
FAX 1-800-369-2440 (USA)
Internet: www.dorner.com

Outside the USA:
TEL 1-262-367-7600
FAX 1-262-367-5827