



Photo Eye Kits & Photo Eye Bracket Kits

Installation, Maintenance and Parts Manual



Photo Eye Kit



Photo Eye Bracket Kit

DORNER MFG. CORP.
P.O. Box 20 • 975 Cottonwood Ave.
Hartland, WI 53029-0020 USA

INSIDE THE USA
TEL: 1-800-397-8664
FAX: 1-800-369-2440

OUTSIDE THE USA
TEL: 262-367-7600
FAX: 262-367-5827

For other service manuals visit our website at:
www.dorner.com/service_manuals.asp

Table of Contents

Introduction	2	Conveyor Indexing	6
Warnings – General Safety	3	To Add Push Button “Bypass Option”	7
Product Description	4	Single Input VFD Motor Control.....	7
Photo Eye Kit.....	4	Dual Input VFD Motor Control.....	7
Photo Eye Bracket Kit	4	Service Parts.....	8
Linking Cable Kit	4	Photo Eye Kit	8
Installation	5	Photo Eye Bracket Kit - Reflective	9
Required Tools.....	5	Photo Eye Bracket Kit - Through Beam	10
Mounting to Conveyor.....	5	Photo Eye Bracket Kit - Convergence	11
Linking Cable Kit	5	Linking Kit	12
Applications.....	6	Notes	13
Conveyor End Stop.....	6	Return Policy.....	14

Introduction

⚠ CAUTION

Some illustrations may show guards removed. DO NOT operate equipment without guards.

Upon receipt of shipment:

- Compare shipment with packing slip. Contact factory regarding discrepancies.
- Inspect packages for shipping damage. Contact carrier regarding damage.
- Accessories may be shipped loose. See accessory instructions for installation.

The Dorner Limited Warranty applies.

Dorner reserves the right to make changes at any time without notice or obligation.

Dorner has convenient, pre-configured kits of Key Service Parts for all conveyor products. These time saving kits are easy to order, designed for fast installation, and guarantee you will have what you need when you need it. Key Parts and Kits are marked in the Service Parts section of this manual with the Performance Parts Kits logo .

Warnings – General Safety

WARNING

The safety alert symbol, black triangle with white exclamation, is used to alert you to potential personal injury hazards.

DANGER



SEVERE HAZARD!
KEEP OFF CONVEYORS. Climbing, sitting, walking or riding on conveyor will cause severe injury.

DANGER



EXPLOSION HAZARD!

- **DO NOT OPERATE CONVEYORS IN AN EXPLOSIVE ENVIRONMENT.** The electric gearmotor generates heat and could ignite combustible vapors.
- Failure to comply will result in death or serious injury.

WARNING

Controller must be properly grounded. Failure to properly ground controller may cause injury to personnel.

DANGER



SEVERE HAZARD!
Hazardous voltage will cause severe injury or death. **LOCKOUT POWER BEFORE WIRING.**

WARNING



SEVERE HAZARD!
Exposed moving parts can cause severe injury. **DO NOT ATTEMPT ADJUSTMENTS WITH CONVEYOR RUNNING. LOCK OUT POWER** before removing guards or performing maintenance.

WARNING



SEVERE HAZARD!

- Dorner cannot control the physical installation and application of conveyors. Taking protective measures is the responsibility of the user.
- When conveyors are used in conjunction with other equipment or as part of a multiple conveyor system, **CHECK FOR POTENTIAL PINCH POINTS** and other mechanical hazards before system start-up.
- Failure to comply could result in serious injury.

Product Description

Photo Eye Kit

Refer to **(Figure 1)** for typical components.

Typical Components	
1	Photo Eye Assembly
2	Reflector Assembly
3	M6-1.00 x 12mm Low Head Cap Screws (x4)
4	Drop in T-Bars (x2)

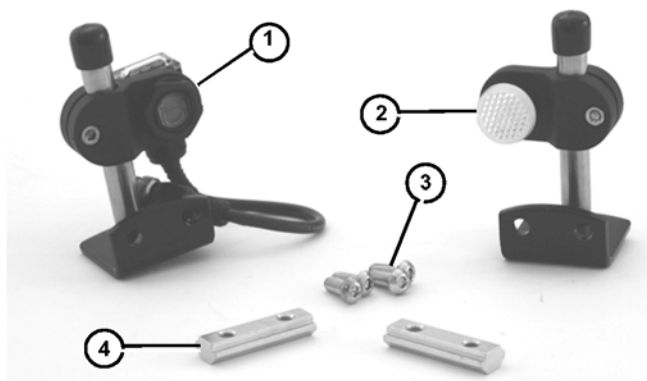

Figure 1

Linking Cable Kit

Refer to **(Figure 3)** for typical components.

Typical Components	
1	Cable - 4P Micro Connect
2	Wire Ties (x3)
3	Drop in T-Bars (x3)
4	M6-1.00 x 20mm Low Head Cap Screws (x3)
5	Mounting Cable Ties (x3)
6	T-Slot Strip Closures (x3)
7	Hex Key

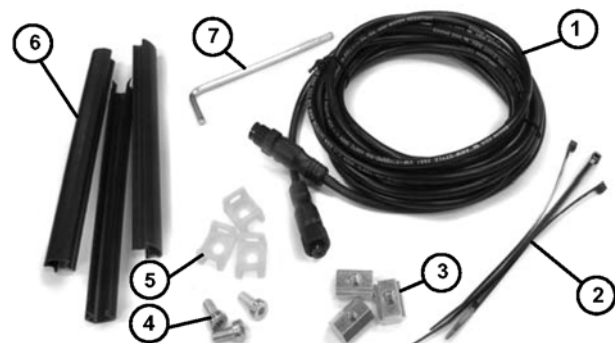

Figure 3

Photo Eye Bracket Kit

Refer to **(Figure 2)** for typical components.

Typical Components	
1	Photo Eye Bracket Assembly
2	Reflector Assembly
3	M6-1.00 x 12mm Low Head Cap Screws (x4)
4	Drop in T-Bars (x2)

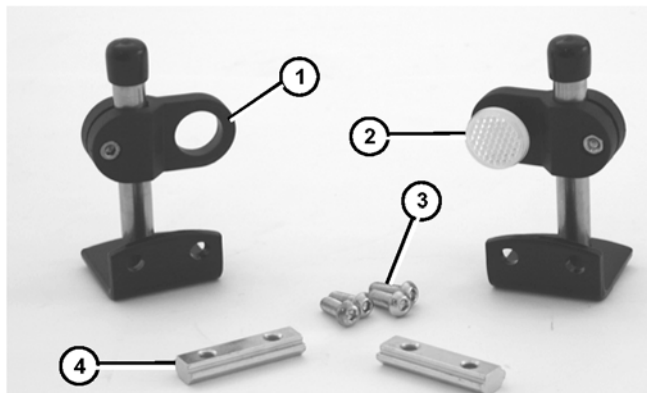

Figure 2

Required Tools

- 6 mm hex head wrench

Mounting to Conveyor

1. Install t-bars (**Figure 4, item 1**) into conveyor t-slot.

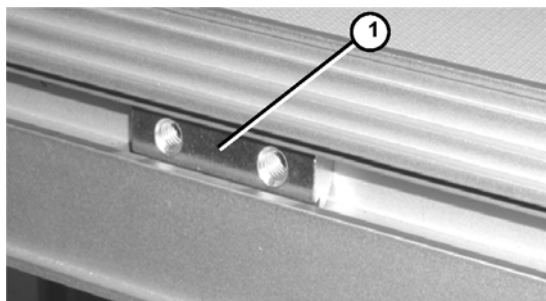

Figure 4

2. Attach photo eye assembly (**Figure 5, item 1**) to conveyor with screws (**Figure 5, item 2**).

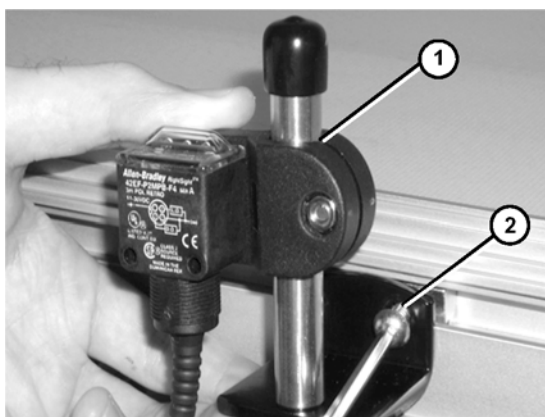

Figure 5

3. Slide photo eye to its desired mounting location along conveyor and tighten both screws.
4. Repeat steps 1-3 for the reflector assembly on opposite side on the conveyor.
5. Attach linking cable to photo eye assembly cable as shown in (**Figure 6**).



Figure 6

Linking Cable Kit

1. To contain a long run of wiring cable in the conveyor t-slot, use several short lengths of t-slot strip closures (**Figure 7, item 1**).

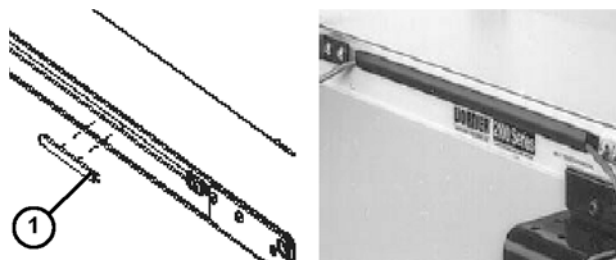

Figure 7

2. To route cable over a previously mounted component or to anchor the cable, use the mounting cable ties (**Figure 8, item 1**) and single drop-in t-bars (**Figure 8, item 2**). Secure with screws (**Figure 8, item 3**).

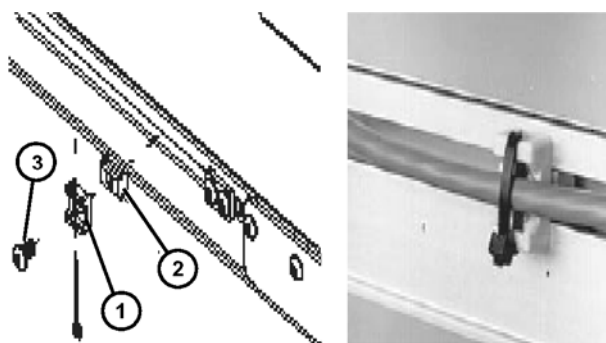

Figure 8

3. (**Figure 9**) shows a typical wire routing or an accessory kit connection to the conveyor using the conveyors t-slot with both t-slot closures and wire ties.



Figure 9

Applications

Conveyor End Stop

Conveyor will run until the photo eye is blocked.

To create an end stop application, connect the photo eye cable (Figure 10, item 1) or (Figure 11, item 1) to the blue port (Figure 10, item 2) or (Figure 11, item 2) on the bottom of the controller.

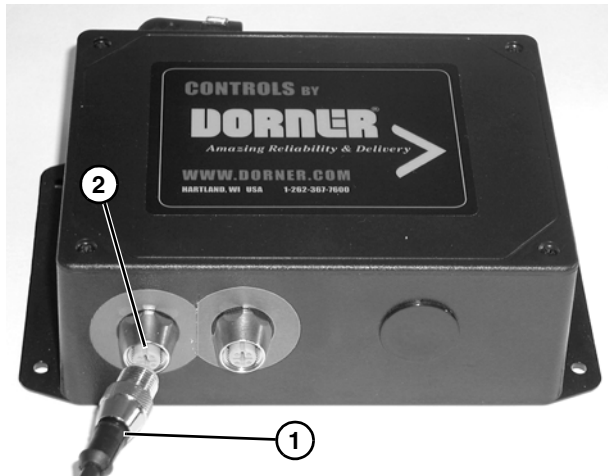

Single Input VFD Motor Control

Figure 10

Conveyor Indexing

Conveyor is stopped and will run when the photo eye is blocked.

To create an indexing application, connect the photo eye cable (Figure 12, item 1) or (Figure 13, item 1) to the green port (Figure 12, item 2) or (Figure 13, item 2) on the bottom of the controller.

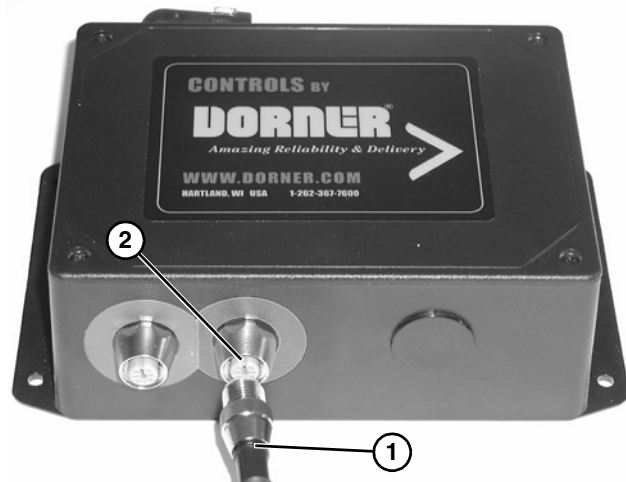

Single Input VFD Motor Control

Figure 12

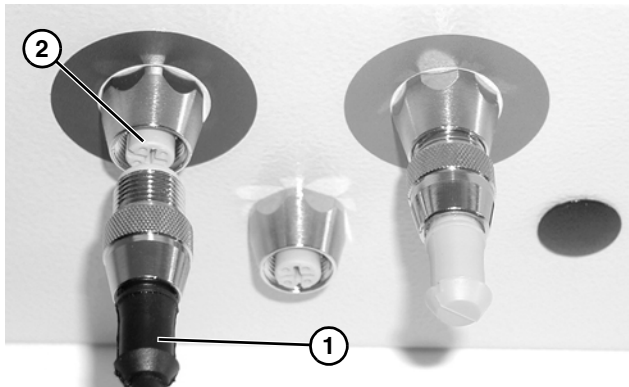

Dual Input Motor Control

Figure 11

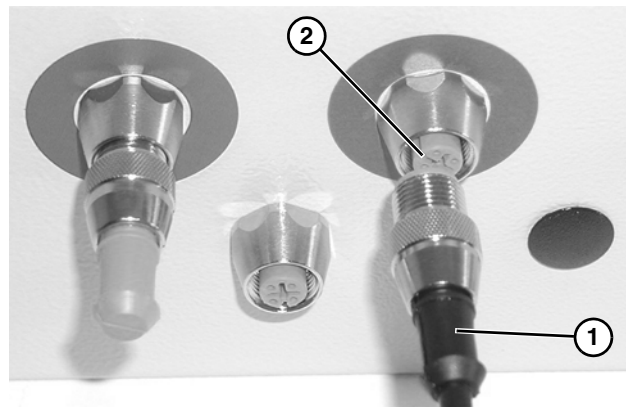

Dual Input Motor Control

Figure 13

For dual input VFD Motor Controller see Motor Controls Manual 851-614 for indexing time delay adjustment options in Preventive Maintenance and Adjustment section.

To Add Push Button “Bypass Option”

The bypass option will allow the conveyor to run while the push button is pressed independent of the photo eye.

Single Input VFD Motor Control

1. Connect push button unused accessory port (**Figure 14, item 1**).

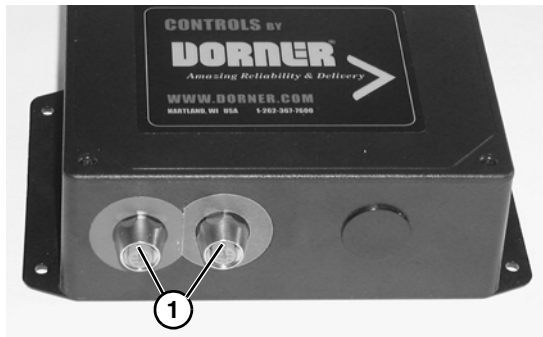

Figure 14

Dual Input VFD Motor Control

1. Connect push button to user selectable port (**Figure 15, item 1**).

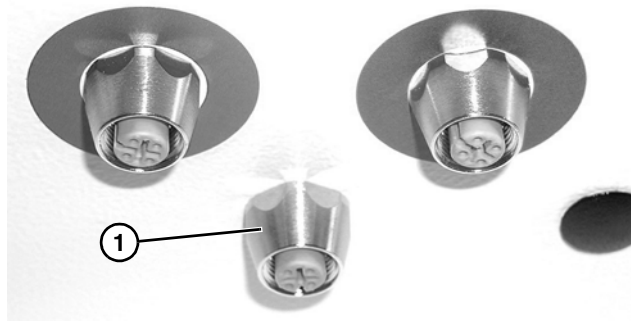

Figure 15

2. Move the internal jumper (**Figure 17, item 1**) to the left to bypass the device in the blue port. Move the jumper (**Figure 18, item 1**) to the right to bypass the device in the green port.

Jumper in the neutral position (**Figure 16, item 1**). The user selectable port will have no function (factory default).

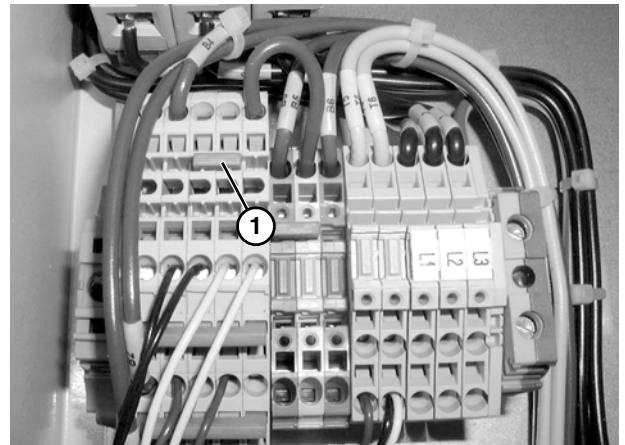

Figure 16

Jumper in the “left” or blue port position (**Figure 17, item 1**). The user selectable port will function the same as the blue port.

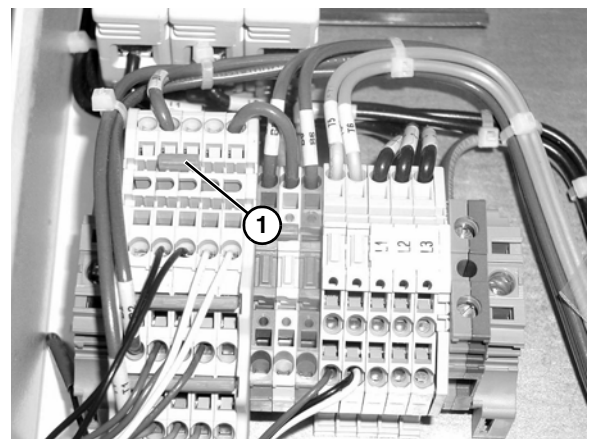

Figure 17

Jumper in the “Right” or green port position (**Figure 18, item 1**). The user selectable port will function the same as the green port.

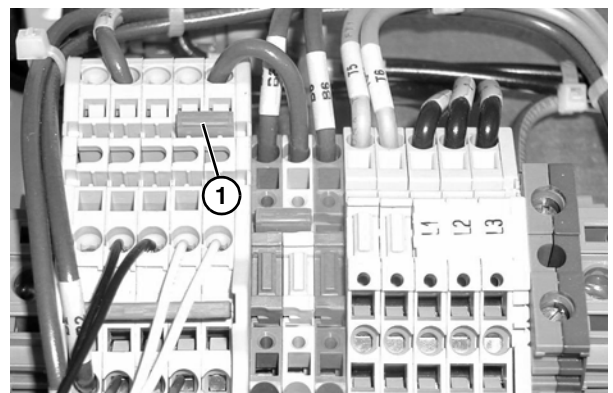

Figure 18

Service Parts

NOTE

For replacement parts other than those shown in this section, contact an authorized Dorner Service Center or the factory. Key Service Parts and Kits are identified by the Performance Parts Kits logo . Dorner recommends keeping these parts on hand.

Photo Eye Kit



Item	Part Number	Description
1	200830M	Drop-In T-bar
2	201104	2" Mounting Sensor Shaft
	202027M	5" Mounting Sensor Shaft
3	807-1390	Reflector Mount Clamp
4	807-1391	Photo Eye Mount Clamp
5	809-289	Reflector Sensor
6	809-315	Photo Eye Sensor
7	202004	Mounting Bracket
8	807-948	Shaft Cap
9	920692M	Low Head Cap Screw M6-1.00 x 12mm
10	920693M	Low Head Cap Screw M6-1.00 x 16mm

Photo Eye Bracket Kit - Reflective

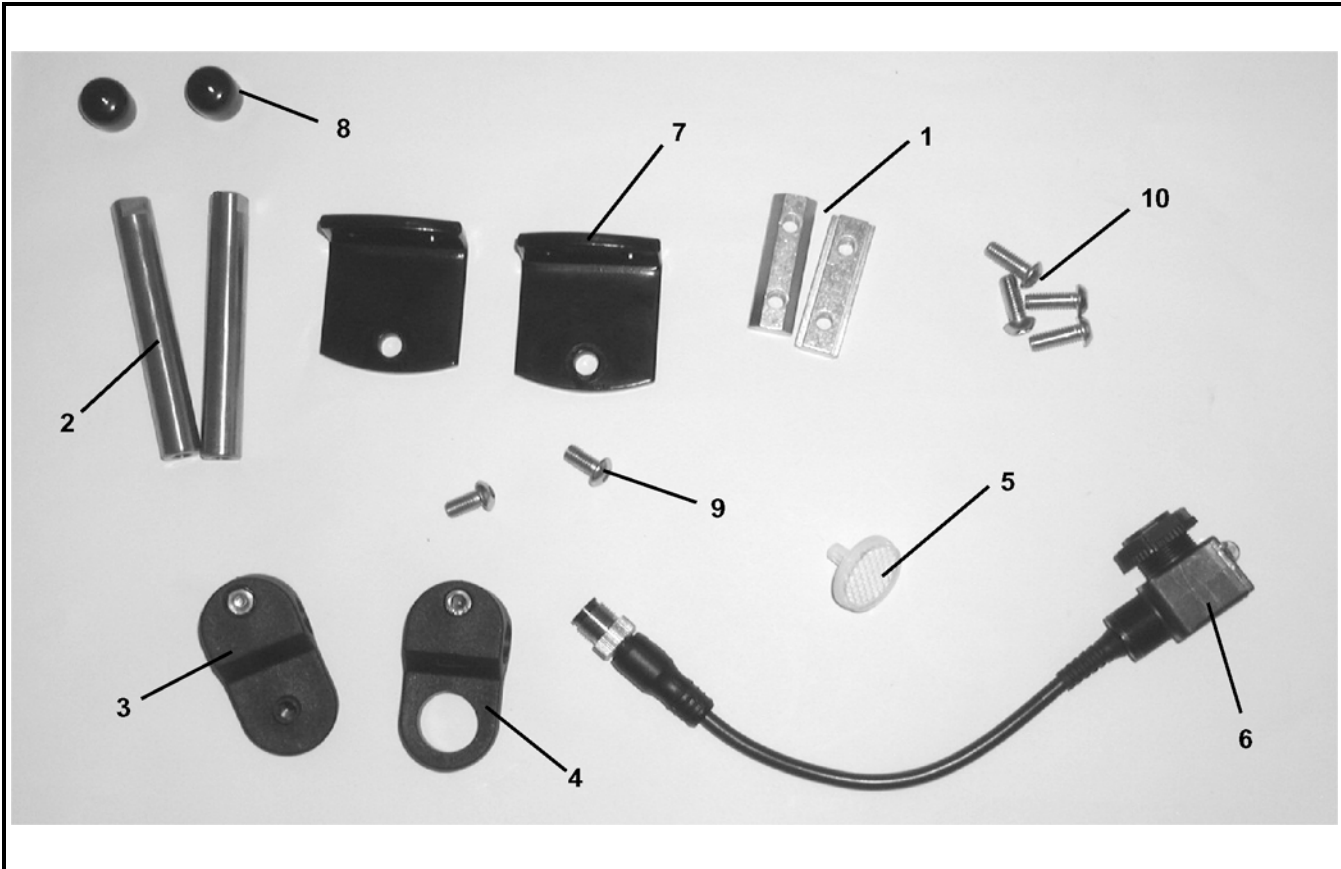
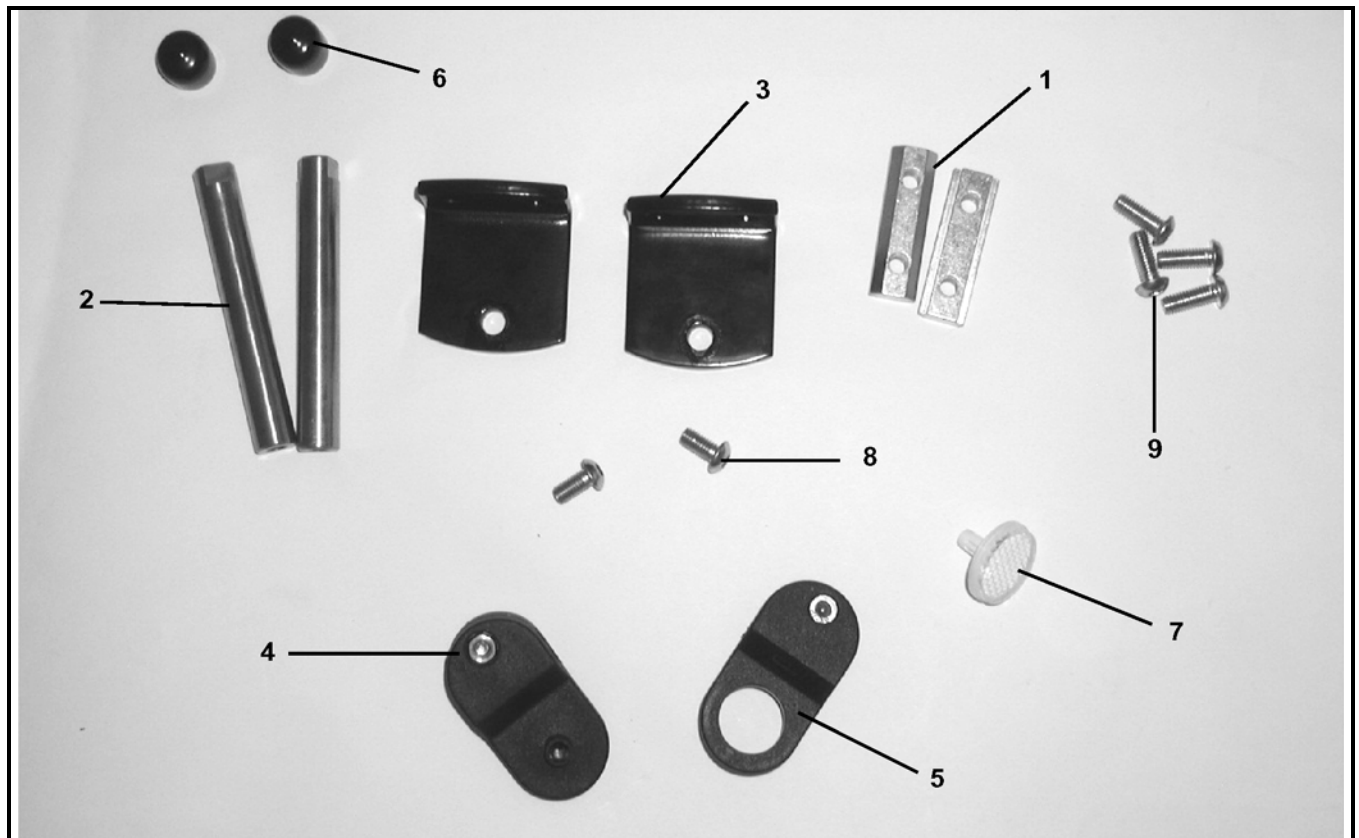

Item	Part Number	Description
1	200830M	Drop-In T-bar
2	201104	2" Mounting Sensor Shaft
	202027M	5" Mounting Sensor Shaft
3	202004	Mounting Bracket
4	807-1390	Reflector Mount Clamp
5	807-1391	Photo Eye Mount Clamp
6	807-948	Shaft Cap
7	809-289	Reflector Sensor
8	920692M	Low Head Cap Screw M6-1.00 x 12mm
9	920693M	Low Head Cap Screw M6-1.00 x 16mm

Service Parts

Photo Eye Bracket Kit - Through Beam

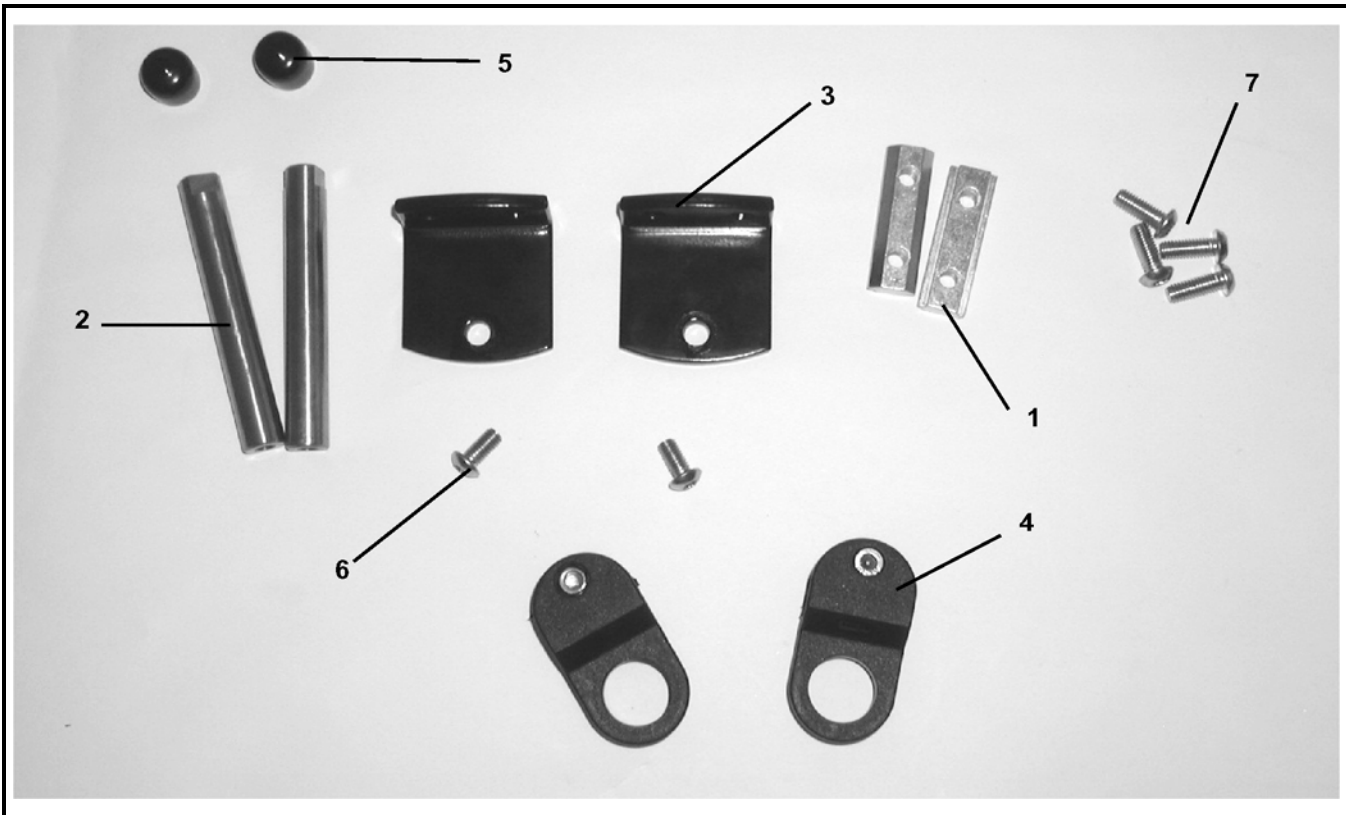

Item	Part Number	Description
1	200830M	Drop-In T-bar
2	201104	2" Mounting Sensor Shaft
	202027M	5" Mounting Sensor Shaft
3	202004	Mounting Bracket
4	807-1391	Photo Eye Mount Clamp
5	807-948	Shaft Cap
6	920692M	Low Head Cap Screw M6-1.00 x 12mm
7	920693M	Low Head Cap Screw M6-1.00 x 16mm

Photo Eye Bracket Kit - Convergence

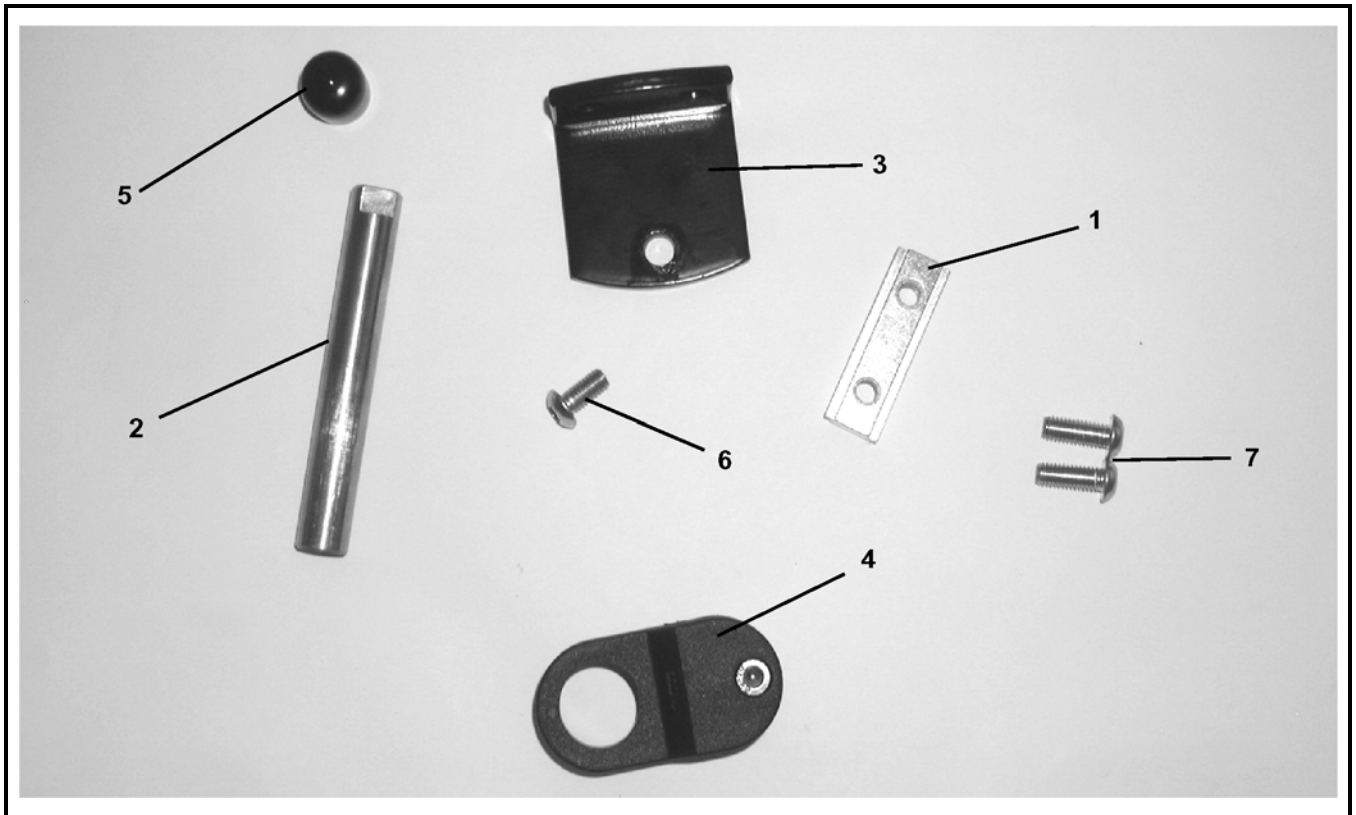

Item	Part Number	Description
1	200830M	Drop-In T-bar
2	201104	2" Mounting Sensor Shaft
	202027M	5" Mounting Sensor Shaft
3	202004	Mounting Bracket
4	807-1391	Photo Eye Mount Clamp
5	807-948	Shaft Cap
6	920692M	Low Head Cap Screw M6-1.00 x 12mm
7	920693M	Low Head Cap Screw M6-1.00 x 16mm

Service Parts

Linking Kit

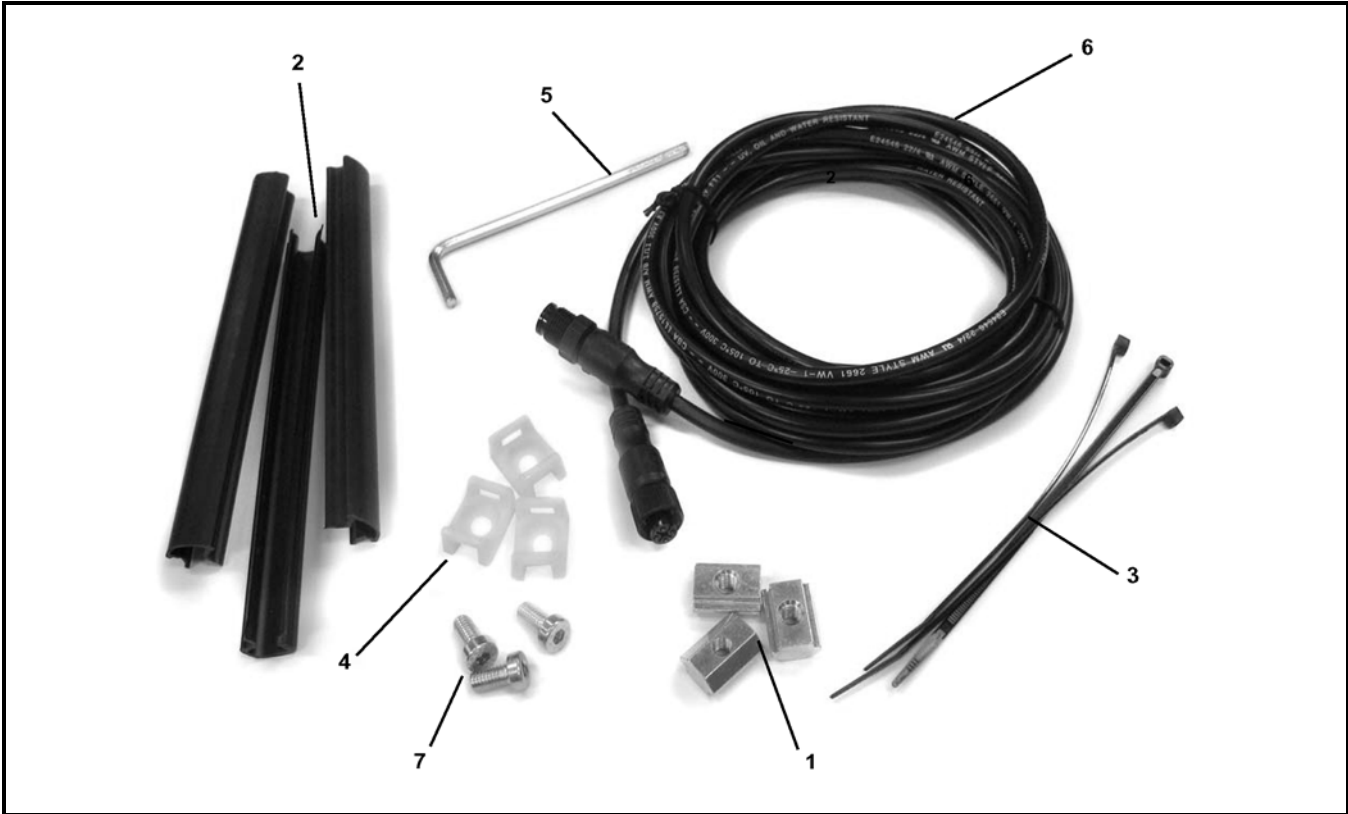

Item	Part Number	Description
1	639971M	Single Drop-In T-bar
2	675232	T-Slot Strip Closure
3	805-063	Wire Tie
4	805-608	Mounting Cable Tie
5	807-565	Hex Key
6	809-312	2 Meter Cable
	809-313	5 Meter Cable
7	920692M	Low Head Cap Screw M6-1.00 x 12mm

Return Policy

Returns must have prior written factory authorization or they will not be accepted. Items that are returned to Dorner without authorization will not be credited nor returned to the original sender. When calling for authorization, please have the following information ready for the Dorner factory representative or your local distributor:

1. Name and address of customer.
2. Dorner part number(s) of item(s) being returned.
3. Reason for return.
4. Customer's original order number used when ordering the item(s).
5. Dorner or distributor invoice number (if available, part serial number).

A representative will discuss action to be taken on the returned items and provide a Returned Goods Authorization (RMA) number for reference. RMA will automatically close 30 days after being issued. To get credit, items must be new and undamaged. There will be a return charge on all items returned for credit, where Dorner was not at fault. It is the customer's responsibility to prevent damage during return shipping. Damaged or modified items will not be accepted. The customer is responsible for return freight.

Conveyors and conveyor accessories

Standard catalog conveyors	30%
MPB, 7200, 7300 Series, cleated and specialty belt	50%
AquaGard & AquaPruf Series conveyors	non-returnable items
Engineered to order products	case by case
Drives and accessories	30%
Sanitary stand supports	non-returnable items

Parts

Standard stock parts	30%
Plastic chain, cleated and specialty belts	non-returnable items

Returns will not be accepted after 60 days from original invoice date. The return charge covers inspection, cleaning, disassembly, disposal and reissuing of components to inventory. If a replacement is needed prior to evaluation of returned item, a purchase order must be issued. Credit (if any) is issued only after return and evaluation is complete.

Dorner has representatives throughout the world. Contact Dorner for the name of your local representative. Our Customer Service Team will gladly help with your questions on Dorner products.

For a copy of Dorner's Warranty, contact factory, distributor, service center or visit our website at www.dorner.com.

For replacement parts, contact an authorized Dorner Service Center or the factory.



Dorner Mfg. Corp. reserves the right to change or discontinue products without notice. All products and services are covered in accordance with our standard warranty. All rights reserved. © Dorner Mfg. Corp. 2010

DORNER MFG. CORP.

975 Cottonwood Ave., PO Box 20
Hartland, WI 53029-0020 USA
TEL 1-800-397-8664 (USA)
FAX 1-800-369-2440 (USA)
Internet: www.dorner.com

Outside the USA:
TEL 1-262-367-7600
FAX 1-262-367-5827