



Industrial and Sanitary Variable Speed VFD Controllers

Installation, Maintenance, and Parts Manual



DORNER MFG. CORP.
P.O. Box 20 • 975 Cottonwood Ave.
Hartland, WI 53029-0020 USA

INSIDE THE USA
TEL: 1-800-397-8664
FAX: 1-800-369-2440

OUTSIDE THE USA
TEL: 262-367-7600
FAX: 262-367-5827

For other service manuals visit our website at:
www.dorner.com/service_manuals.asp

Table of Contents

Introduction	2	Sanitary Controller Mounting	
Warnings – General Safety	3	(7350, 7400 and 7600 Series Conveyors)	7
Product Description	4	Industrial Controller Mounting	8
Specifications	4	2200, 3200 and 5200 Conveyor Mounting	8
Industrial Controllers	4	6200 Conveyor Mounting	9
Sanitary Controllers	5	Aluminum Stand Leg Mounting	10
Installation	6	Wiring	11
Required Tools	6	Preventive Maintenance and Adjustment	12
Determine Conveyor Type	6	Required Tools	12
Sanitary Conveyors	6	Controller Setup	12
Industrial Conveyors	6	Service Parts	12
Sanitary Controller Mounting		Notes	13
(7200 and 7300 Series Conveyors)	6	Return Policy	14

Introduction

IMPORTANT

Some illustrations may show guards removed. Do NOT operate equipment without guards.
--

Upon receipt of shipment:

- Compare shipment with packing slip. Contact factory regarding discrepancies.
- Inspect packages for shipping damage. Contact carrier regarding damage.
- Accessories may be shipped loose. See accessory instructions for installation.

Dorner conveyors are covered by the following patent numbers: 5131529, 5156260, 5156261, 5174435, 5203447, 5265714, 5875883, and corresponding patents and patent applications in other countries.

Dorner's Limited Warranty applies.

Dorner reserves the right to make changes at any time without notice or obligation.

Warnings – General Safety

WARNING

The safety alert symbol, black triangle with white exclamation, is used to alert you to potential personal injury hazards.

DANGER



Climbing, sitting, walking or riding on conveyor will cause severe injury.
KEEP OFF CONVEYORS.

DANGER



DO NOT OPERATE CONVEYORS IN AN EXPLOSIVE ENVIRONMENT.

WARNING

Controller must be properly grounded. Failure to properly ground controller may cause injury to personnel.

DANGER



Hazardous voltage will cause severe injury or death.
LOCKOUT POWER BEFORE wiring.

WARNING



Exposed moving parts can cause severe injury.
DO NOT ATTEMPT ADJUSTMENTS WITH CONVEYOR RUNNING.

WARNING



Dorner cannot control the physical installation and application of conveyors. Taking protective measures is the responsibility of the user.

When conveyors are used in conjunction with other equipment or as part of a multiple conveyor system, **CHECK FOR POTENTIAL PINCH POINTS** and other mechanical hazards before system start-up.

Product Description

Dorner Variable Speed VFD Controllers (**Figure 1**) are AC motor speed controllers for Standard and Heavy Load VFD gearmotors.

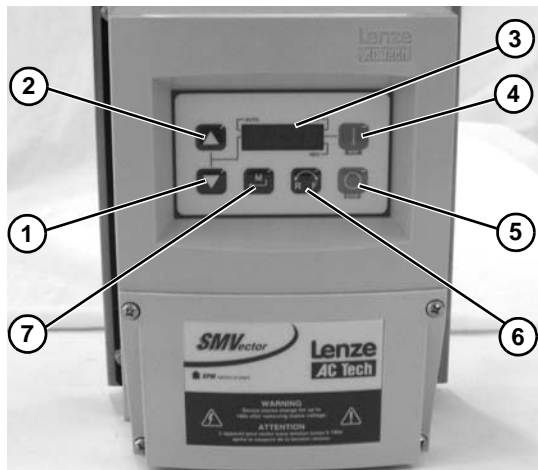

Figure 1

NOTE

For additional information, refer to the Lenze SMVector Frequency Inverter Operating Instructions shipped with your controller. See Specifications table for models.

Illustration References:

- | | |
|---|----------------------------------|
| 1 | Decrease Speed Button |
| 2 | Increase Speed Button |
| 3 | Display |
| 4 | Start Button |
| 5 | Stop Button |
| 6 | FWD/REV (Forward/Reverse) Button |
| 7 | Enter Button |

Specifications

Industrial Controllers

Dorner Model Number	Input Voltage (VAC) & Phase	Input Frequency (Hz)	Output Voltage (VAC) & Phase	Output Frequency (Hz)	Max. HP (kW)	Max. Output in Amps	Manufacturer's Model Number
32MV1122(o)	115 Volts Single Phase	60	230 Volts Three Phase	6 to 60	0.5 (0.37)	2.2	ESV371N01SXC
32MV2122(o)	230 Volts Single Phase	60	230 Volts Three Phase	6 to 60	0.5 (0.37)	2.2	ESV371N01SXC
32MV1121(o)	115 Volts Single Phase	60	230 Volts Three Phase	6 to 60	1.0 (0.75)	4	ESV751N01SXC
32MV2121(o)	230 Volts Single Phase	60	230 Volts Three Phase	6 to 60	1.0 (0.75)	4	ESV751N01SXC
32MV2127(o)	230 Volts Single Phase	60	230 Volts Three Phase	6 to 60	2.0 (1.5)	6.8	ESV152N02YXC
32MV2322(o)	230 Volts Three Phase	60	230 Volts Three Phase	6 to 60	0.5 (0.37)	2.2	ESV371N02YXC
32MV2327(o)	230 Volts Three Phase	60	230 Volts Three Phase	6 to 60	2.0 (1.5)	6.8	ESV152N02YXC
32MV4341(o)	460 Volts Three Phase	60	460 Volts Three Phase	6 to 60	1.0 (0.75)	2	ESV751N04TXC
32MV4347(o)	460 Volts Three Phase	60	460 Volts Three Phase	6 to 60	2.0 (1.5)	3.4	ESV152N04TXC
62UV2121(o)	230 Volts Single Phase	50	230 Volts Three Phase	25 to 63	1.0 (0.75)	4	ESV751N02SFC
62UV4341(o)	400 Volts Three Phase	50	400 Volts Three Phase	25 to 63	1.0 (0.75)	2	ESV751N04TFC
62UV2127(o)	230 Volts Single Phase	50	230 Volts Three Phase	25 to 63	2.0 (1.5)	6.8	ESV152N02SFC
62UV4347(o)	400 Volts Three Phase	50	230 Volts Three Phase	25 to 63	2.0 (1.5)	3.4	ESV152N04TFC

(o): Blank = No Accessory Port; E = M12 Accessory Port Wired for End Stop Photo Eye Application; I = M12 Accessory Port Wired for Indexing Photo Eye Application

Sanitary Controllers

Dorner Model Number	Input Voltage (VAC) & Phase	Input Frequency (Hz)	Output Voltage (VAC) & Phase	Output Frequency (Hz)	Max. HP (kW)	Max. Output in Amps	Manufacturer's Model Number
72MV1124S	115 Volts Single Phase	60	230 Volts Three Phase	10 to 60	0.25 (0.18)	1.4	ESV371N01SXC
72MV2124S	230 Volts Single Phase	60	230 Volts Three Phase	10 to 60	0.25 (0.18)	1.4	ESV371N01SXC
72MV1122S	115 Volts Single Phase	60	230 Volts Three Phase	10 to 60	0.5 (0.37)	2.2	ESV371N01SXC
72MV2322S	230 Volts Three Phase	60	230 Volts Three Phase	10 to 60	0.5 (0.37)	2.2	ESV371N02YXC
76MV1122S	115 Volts Single Phase	60	230 Volts Three Phase	10 to 60	0.5 (0.37)	2.2	ESV371N01SXC
76MV2322S	230 Volts Three Phase	60	230 Volts Three Phase	10 to 60	0.5 (0.37)	2.2	ESV371N02YXC
76MV1121S	115 Volts Single Phase	60	230 Volts Three Phase	10 to 60	1.0 (0.75)	4	ESV751N01SXC
76MV2121S	230 Volts Single Phase	60	230 Volts Three Phase	10 to 60	1.0 (0.75)	4	ESV751N01SXC
76MV4341S	460 Volts Three Phase	60	460 Volts Three Phase	10 to 60	1.0 (0.75)	2	ESV751N04TXC
76MV2127S	230 Volts Single Phase	60	230 Volts Three Phase	10 to 60	2.0 (1.5)	6.8	ESV152N02YXC
76MV2327S	230 Volts Three Phase	60	230 Volts Three Phase	10 to 60	2.0 (1.5)	6.8	ESV152N02YXC
76MV4347S	460 Volts Three Phase	60	460 Volts Three Phase	10 to 60	2.0 (1.5)	3.4	ESV152N04TXC
72UV2121S	230 Volts Single Phase	50	230 Volts Three Phase	25 to 63	1.0 (0.75)	4	ESV751N02SFC
72UV4341S	400 Volts Three Phase	50	400 Volts Three Phase	25 to 63	1.0 (0.75)	2	ESV751N04TFC

NOTE

All XXUV VFD's are supplied with an inline line filter to meet EN 61800-3 or other EMC standards. Consult the safety information section of the vendor manual.

Installation

Required Tools

- Hex key wrenches:
4 mm, 5 mm
- Wrenches 8 mm, 10 mm
- Flat-blade screwdriver
- Torque wrench

Determine Conveyor Type

Select the appropriate section based on your conveyor type:

Sanitary Conveyors

- For 7200 and 7300 series conveyors, see “Sanitary Controller Mounting (7200 and 7300 Series Conveyors)” on page 6.
- For 7350, 7400 and 7600 series conveyors, see “Sanitary Controller Mounting (7350, 7400 and 7600 Series Conveyors)” on page 7.

Industrial Conveyors

- For 2200, 3200 and 5200 series conveyors, see “2200, 3200 and 5200 Conveyor Mounting” on page 8.
- For 6200 series conveyors, see “6200 Conveyor Mounting” on page 9.
- For aluminum stand leg mounting, see “Aluminum Stand Leg Mounting” on page 10.

Sanitary Controller Mounting (7200 and 7300 Series Conveyors)

⚠ WARNING

<p>Exposed moving parts can cause severe injury. LOCK OUT POWER before removing guards or performing maintenance.</p>

Installation Component List (Figure 2):

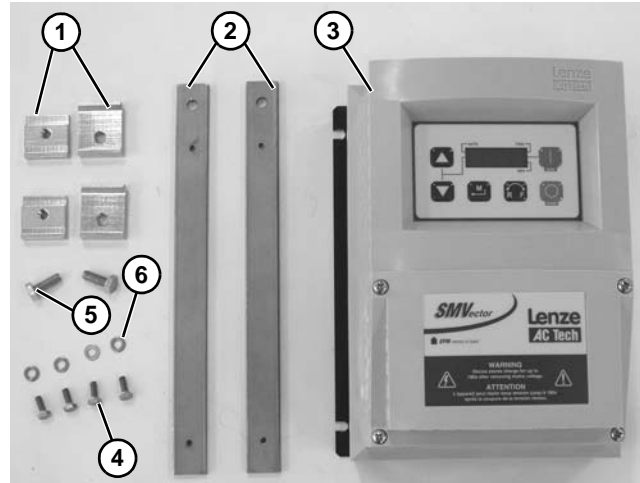

Figure 2

- | | |
|---|---|
| 1 | Accessory Mounting Clips (2x)
(Shipped with gearmotor mount package) |
| 2 | Controller Mounting Bar (2x) |
| 3 | Sanitary VFD Controller |
| 4 | Hex Head Screws, M5 x 8 mm (4x) |
| 5 | Hex Head Screws, M6 x 16 mm (2x) |
| 6 | Washers, M5 (4x) |

1. Attach mounting bars (Figure 3, item 1) to controller (Figure 3, item 2) with washers (Figure 3, item 3) and screws (Figure 3, item 4).

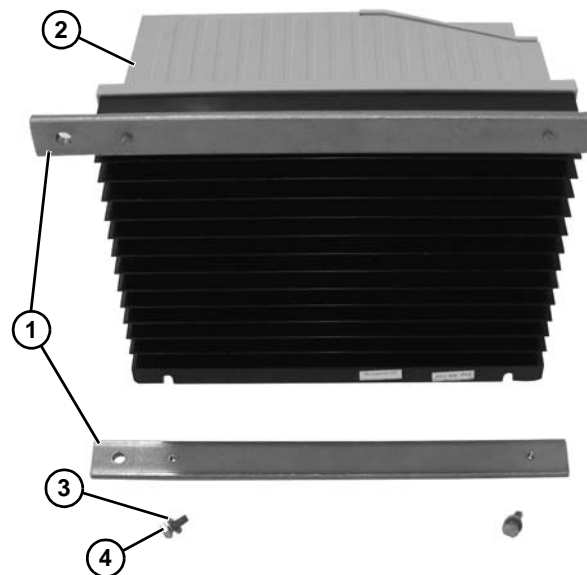

Figure 3

- Loosely attach clips (Figure 4, item 1) to mounting bar (Figure 4, item 2) with M6 x 16 mm screws (Figure 4, item 3).

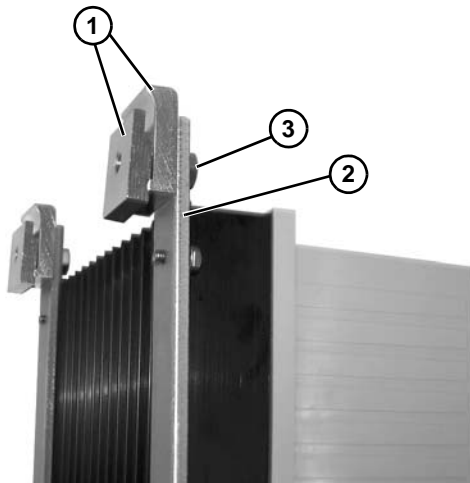

Figure 4

- Attach controller (Figure 5, item 1) to conveyor (Figure 5, item 2) with screws (Figure 5, item 3).

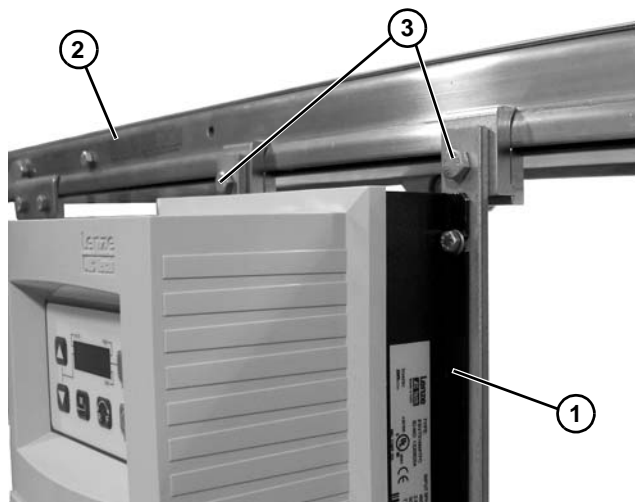

Figure 5

Sanitary Controller Mounting (7350, 7400 and 7600 Series Conveyors)

⚠ WARNING
<p>Exposed moving parts can cause severe injury.</p> <p>LOCK OUT POWER before removing guards or performing maintenance.</p>

Installation Component List (Figure 6):

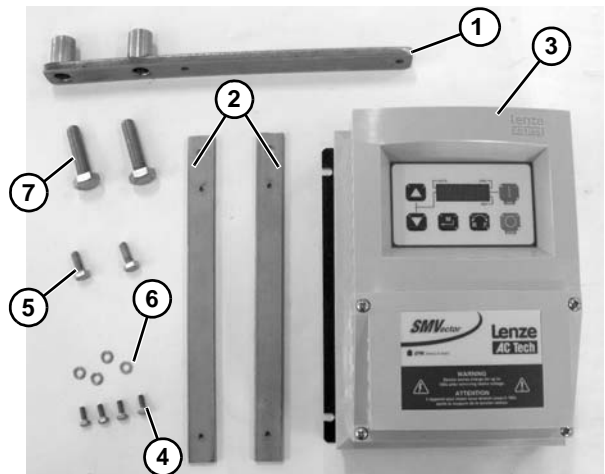

Figure 6

- | | |
|---|----------------------------------|
| 1 | Conveyor Mounting Bar |
| 2 | Controller Mounting Bar (2x) |
| 3 | Sanitary VFD Controller |
| 4 | Hex Head Screws, M5 x 8 mm (4x) |
| 5 | Hex Head Screws, M6 x 16 mm (2x) |
| 6 | Washers, M5 (4x) |
| 7 | Hex Head Screws, M10 (2x) |

- Attach controller mounting bars (Figure 7, item 1) to controller (Figure 7, item 2) with washers (Figure 7, item 3) and screws (Figure 7, item 4).

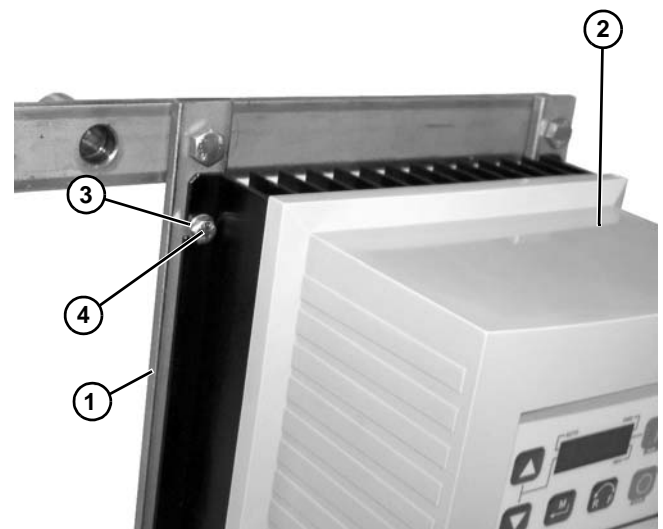

Figure 7

Installation

- Attach controller mounting bars (Figure 8, item 1) to conveyor mounting bar (Figure 8, item 2) with M6x16 mm screws (Figure 8, item 3).

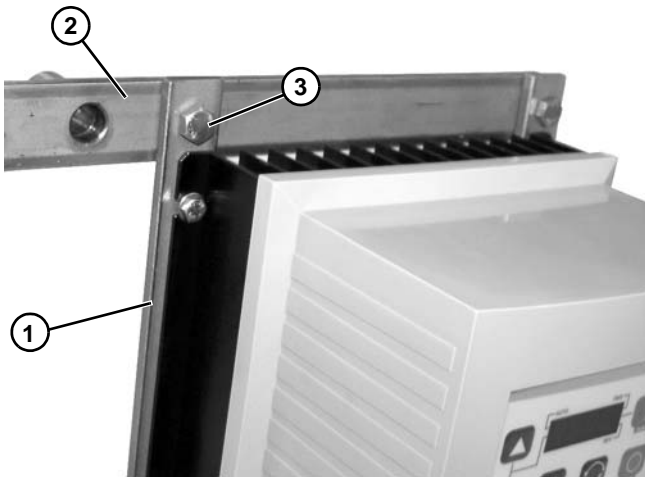

Figure 8

- Install assembly to conveyor at stand location. Remove stand screws and replace with new screws (Figure 9, item 1).

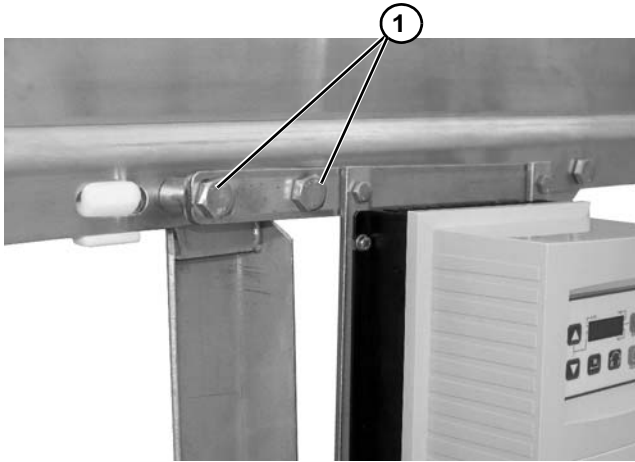

Figure 9

Industrial Controller Mounting

⚠ WARNING
<p>Exposed moving parts can cause severe injury. LOCK OUT POWER before removing guards or performing maintenance.</p>

2200, 3200 and 5200 Conveyor Mounting

Installation Component List (Figure 10):

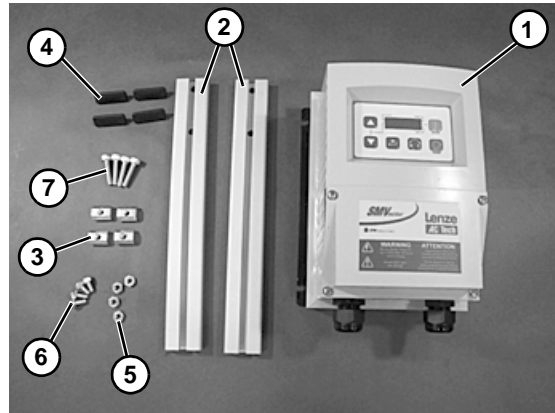

Figure 10

1	Industrial VFD Controller
2	Mounting Bars (x2)
3	Drop-In Tee Bars (x4)
4	End Caps (x4)
5	Hex Nuts (x4)
6	Socket Head Screws, M5 x 10 mm (x4)
7	Socket Head Screws, M6 x 25 mm (x4)

- Insert two hex nuts (Figure 11, item 1) into slot on each mounting bar (Figure 11, item 2).

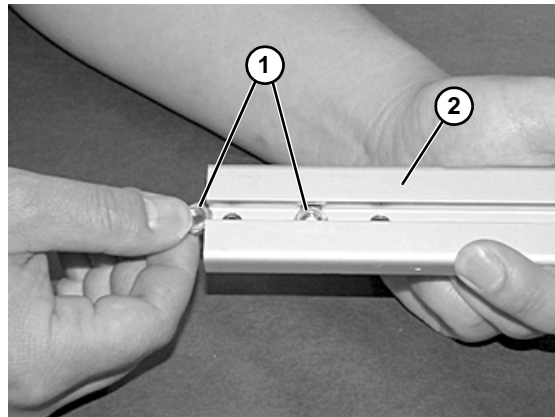

Figure 11

2. Insert end caps (Figure 12, item 1) into ends of mounting bars (Figure 12, item 2).

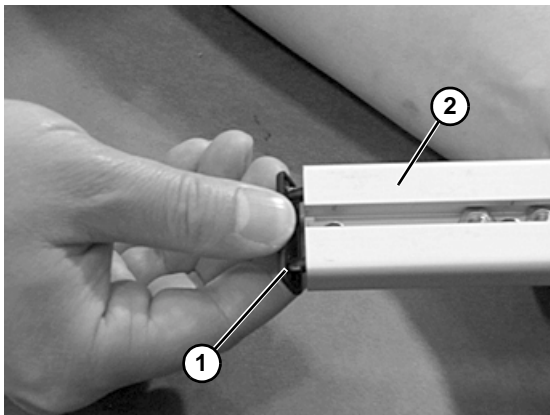

Figure 12

3. Attach mounting bars (Figure 13, item 1) to controller with M5 screws (Figure 13, item 2).

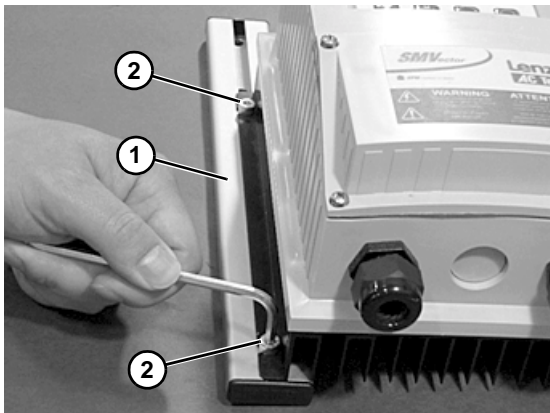

Figure 13

4. Install T-bars (Figure 14, item 1) in 2200 Series, 3200 Series, or 5200 Series conveyor T-slots.

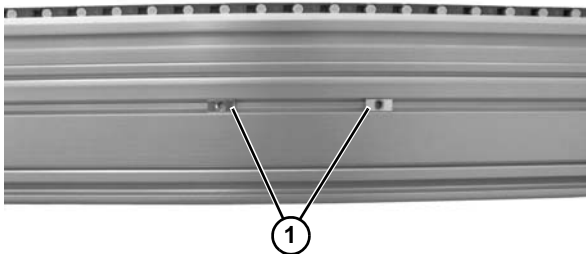

Figure 14

5. Attach controller (Figure 15, item 1) to conveyor with M6 screws (Figure 15, item 2).

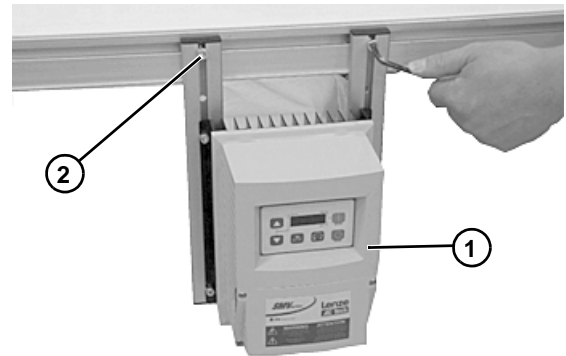



Figure 15

6200 Conveyor Mounting

⚠ WARNING



Exposed moving parts can cause severe injury.
LOCK OUT POWER before removing guards or performing maintenance.

Installation Component List (Figure 16):

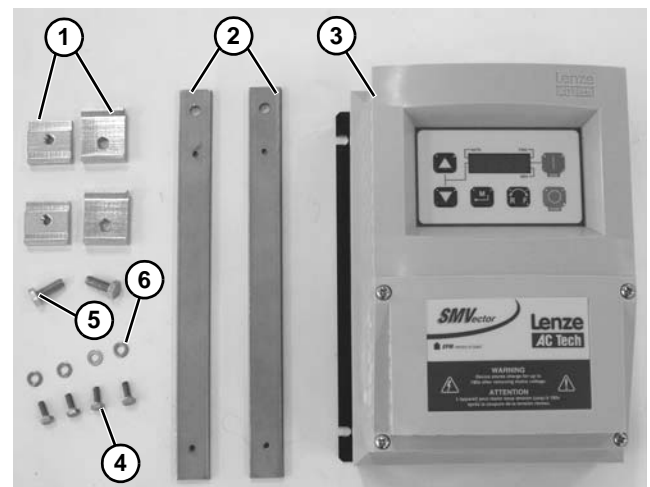

Figure 16

- | | |
|---|---|
| 1 | 6200 Series Accessory Mounting Clips (2x) |
| 2 | Controller Mounting Bar (2x) |
| 3 | Industrial VFD Controller |
| 4 | Hex Head Screws, M5 x 8 mm (4x) |
| 5 | Hex Head Screws, M6 x 16 mm (2x) |
| 6 | Washers, M5 (4x) |

Installation

1. Attach mounting bars (**Figure 17, item 1**) to controller (**Figure 17, item 2**) with washers (**Figure 17, item 3**) and screws (**Figure 17, item 4**).

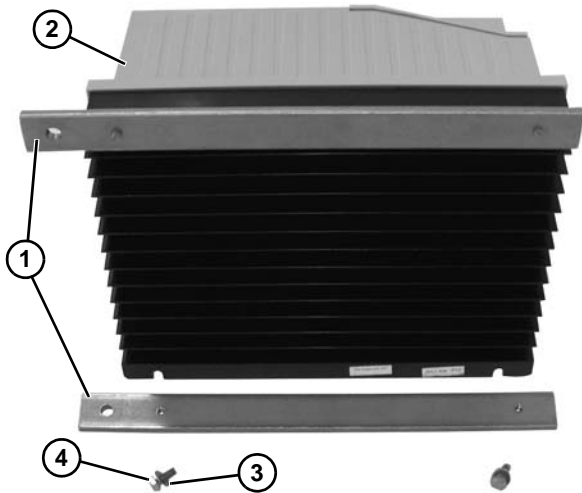

Figure 17

2. Loosely attach clips (**Figure 18, item 1**) to mounting bar (**Figure 18, item 2**) with M6 x 16 mm screws (**Figure 18, item 3**).

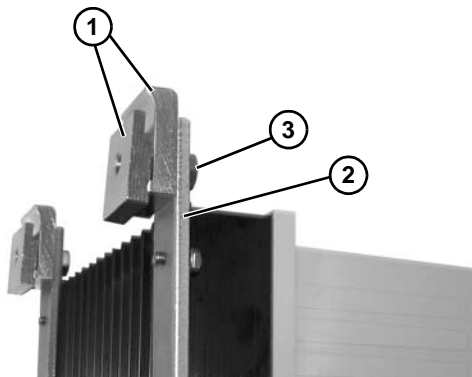

Figure 18

3. Attach controller (**Figure 19, item 1**) to conveyor (**Figure 19, item 2**) with screws (**Figure 19, item 3**).

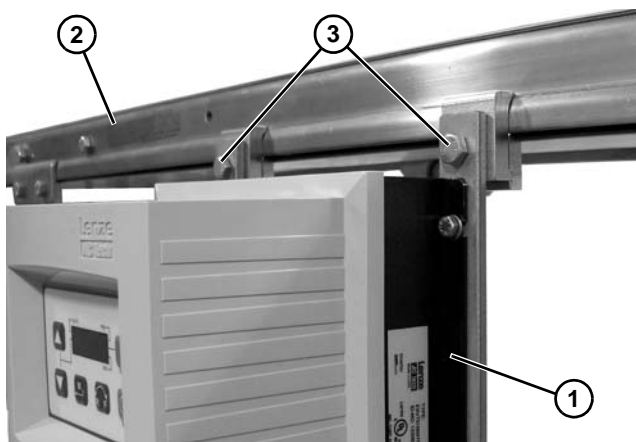

Figure 19

Aluminum Stand Leg Mounting

1. Attach mounting bars (**Figure 20, item 1**) to controller (**Figure 20, item 2**) with M5 x 8 mm screws (**Figure 20, item 3**) and M5 washers (**Figure 20, item 4**).

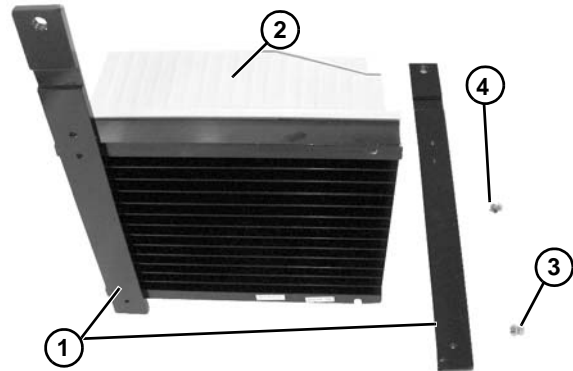

Figure 20

2. Install T-bar (**Figure 21, item 1**) into stand leg T-slot. Attach controller lower mounting bar (**Figure 21, item 2**) with screw (**Figure 21, item 3**).

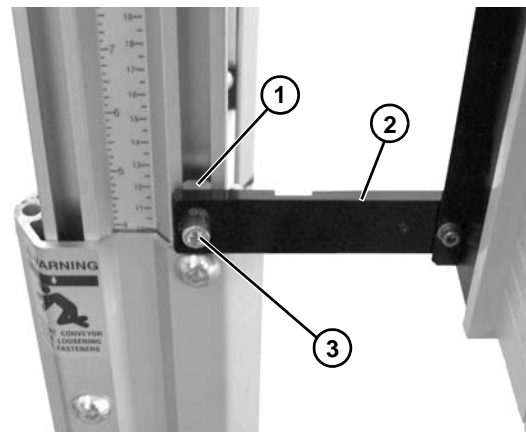

Figure 21

3. Temporarily tighten screw (**Figure 22, item 1**). Install second T-bar (**Figure 22, item 2**) into T-slot.

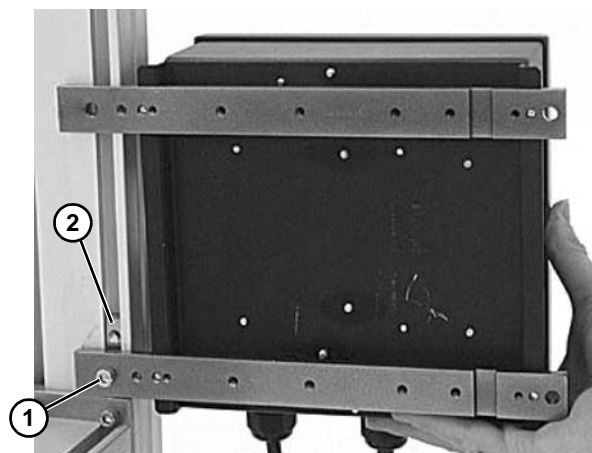

Figure 22

- With screwdriver (Figure 23, item 1), raise T-bar (Figure 23, item 2) to align it with hole in top mounting bar. Insert M6 screw (Figure 23, item 3) and partially thread into T-bar.

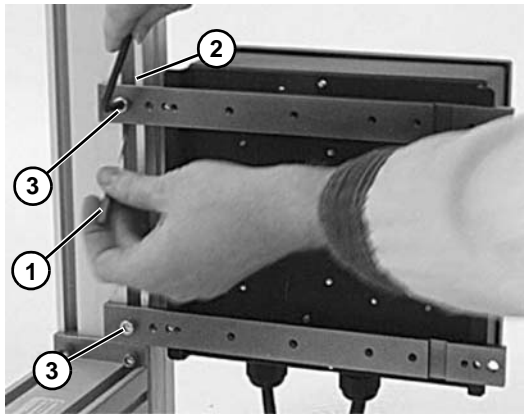

Figure 23

- Slide controller to its desired mounting location (Figure 24, item 1) and tighten both screws (Figure 24, item 2).



Figure 24

Wiring

⚠ DANGER



Hazardous voltage will cause severe injury or death.

LOCKOUT POWER BEFORE wiring.

⚠ WARNING



Exposed moving parts can cause severe injury.

LOCK OUT POWER before removing guards or performing maintenance.

⚠ WARNING

Controller must be properly grounded. Failure to properly ground control box may cause injury to personnel.

NOTE

A circuit breaker or a disconnect switch with fuses must be provided in accordance with the National Electrical Code (NEC) and all local codes.

Refer to Lenze Installation and Operating Manual shipped with your controller.

NOTE

For electrical wiring or troubleshooting, refer to information provided by controller manufacturer.

- Make the input power connections through the line connection cord grip. Refer to the manufacturer's manual for terminations inside the VFD controller.

Preventive Maintenance and Adjustment

Required Tools

- Flat-blade screwdriver

Controller Setup

⚠ DANGER

Hazardous voltage will cause severe injury or death. LOCKOUT POWER BEFORE wiring.

⚠ WARNING

Exposed moving parts can cause severe injury. LOCK OUT POWER before removing guards or performing maintenance.

NOTE
<i>For additional information or desired settings other than listed, refer to the Lenze SMVector Frequency Inverter Operating Instructions shipped with your controller. See Specifications table for model.</i>

When purchased with a gearmotor, Dorner configures Variable Speed VFD Controllers as follows:

- 1 second acceleration time
- 1 second deceleration time
- Minimum frequency @ 10 Hz for Sanitary units, 6 Hz for Industrial units
- Maximum frequency @ 60 Hz
- Overloads set to motor Full Load Amperes (FLA)

Service Parts

NOTE
<i>For replacement parts, refer to the manual shipped with your controller.</i>

Return Policy

Returns must have prior written factory authorization or they will not be accepted. Items that are returned to Dorner without authorization will not be credited nor returned to the original sender. When calling for authorization, please have the following information ready for the Dorner factory representative or your local distributor:

1. Name and address of customer.
2. Dorner part number(s) of item(s) being returned.
3. Reason for return.
4. Customer's original order number used when ordering the item(s).
5. Dorner or distributor invoice number (if available, part serial number).

A representative will discuss action to be taken on the returned items and provide a Returned Goods Authorization (RMA) number for reference. RMA will automatically close 30 days after being issued. To get credit, items must be new and undamaged. There will be a return charge on all items returned for credit, where Dorner was not at fault. It is the customer's responsibility to prevent damage during return shipping. Damaged or modified items will not be accepted. The customer is responsible for return freight.

Product Type									
Standard Products									Engineered to order parts
Product Line	Conveyors	Gearmotors & Mounting Packages	Support Stands	Accessories	Spare Parts (non-belt)	Spare Belts - Standard Flat Fabric	Spare Belts - Cleated & Specialty Fabric	Spare Belts - Plastic Chain	All equipment and parts
1100	30% return fee for all products except: 50% return fee for conveyors with modular belt, cleated belt or specialty belts						non-returnable		case-by-case
2200									
2200 Modular Belt									
2200 Precision Move									
2300									
2300 Modular Belt									
3200									
3200 LPZ									
3200 Precision Move									
4100									
5200									
5300									
6200									
Controls									
7200 / 7300	50% return fee for all products								
7350	non-returnable								
7360									
7400									
7600									

Returns will not be accepted after 60 days from original invoice date. The return charge covers inspection, cleaning, disassembly, disposal and reissuing of components to inventory. If a replacement is needed prior to evaluation of returned item, a purchase order must be issued. Credit (if any) is issued only after return and evaluation is complete.

Dorner has representatives throughout the world. Contact Dorner for the name of your local representative. Our Customer Service Team will gladly help with your questions on Dorner products.

For a copy of Dorner's Warranty, contact factory, distributor, service center or visit our website at www.dorner.com.

For replacement parts, contact an authorized Dorner Service Center or the factory.

 <p>Dorner Mfg. Corp. reserves the right to change or discontinue products without notice. All products and services are covered in accordance with our standard warranty. All rights reserved. © Dorner Mfg. Corp. 2006</p>	<p>DORNER MFG. CORP. 975 Cottonwood Ave., PO Box 20 Hartland, WI 53029-0020 USA USA TEL 1-800-397-8664 (USA) FAX 1-800-369-2440 (USA) Internet: www.dorner.com</p>	<p>Outside the USA: TEL 1-262-367-7600 FAX 1-262-367-5827</p>
---	---	---